

iNTEC[®]
LIGHT

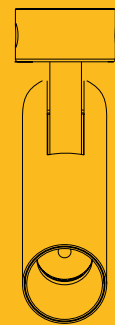

FOXLED[®] ALL YOUR LIGHT



BRIGHT SOLUTIONS

INTEC[®]
LIGHT

**Quando la ricerca trova risposte alle esigenze, vecchie e nuove.
Quando la tecnologia risolve problemi.
Quando tecnica ed estetica si fondono armoniosamente.**

Lì, nascono le soluzioni più brillanti.

When research finds solutions to needs, both old and new.
When technology solves problems.
When technology and aesthetic appeal harmoniously merge.

That's when the bright solutions are born.

faneurope



**Un'evoluzione
lunga oltre
100 anni**

La nostra storia comincia a Napoli agli inizi del '900. È una storia di impegno, di evoluzione, di coraggio. Una storia che corre lungo il filo del tempo intrecciandosi costantemente con quella del vetro. Generazione dopo generazione, **FAN Europe Lighting** evolve, cambia forma, sviluppa la sua idea di prodotto e di servizio, con l'obiettivo di diventare un punto di riferimento per tutto il settore dell'illuminazione.

**La nostra
azienda, oggi**

Oggi **FAN Europe Lighting** è una grande squadra di persone e di risorse. Alla ricerca dell'eccellenza nella qualità dei prodotti, abbiniamo un ecosistema di servizi e garanzie che abbiamo sviluppato e strutturato a misura di esigenza e di cliente. La nostra italian heritage non ci fa dimenticare l'importanza dell'originalità e della cura nel prodotto. La nostra voglia di crescere ci spinge ad essere sempre al passo con la luce di oggi e di domani, una luce sempre più smart, sempre più green, sempre in evoluzione.

Our history began in Naples in the early 1900s. It's a history of commitment, evolution and courage. A history that follows the thread of time, constantly intertwining with that of glass. Generation after generation, **FAN Europe Lighting** has evolved, changing shape, developing its concept of products and services to become a benchmark for the entire lighting industry.

**An evolution
spanning more
than 100 years**

Today, **FAN Europe Lighting** is a vast team of people and resources. In addition to pursuing excellence in product quality, we combine an ecosystem of services and guarantees, which we have developed and tailored to our customers' needs. Our Italian heritage does not allow us to forget the importance of originality and product care. Our desire to grow motivates us to always keep up with the lighting of today and tomorrow, lighting that is always smarter, more eco-friendly and evolving.

**Our
company,
today**

UNA SINERGIA DI RISORSE E GARANZIE / A SYNERGY OF RESOURCES AND GUARANTEES

Un'assistenza sempre attiva

Noi ci siamo, sempre!
Con disponibilità, professionalità e un obiettivo chiaro: semplificare la vita dei nostri clienti. È una promessa che facciamo a chi non ci conosce. E' una garanzia consolidata per chi lavora con noi da anni!

We are always here for you!
With our helpfulness, professionalism and a clear goal: to make life easier for our customers. It's a promise we make to those who don't know us. It's an established guarantee for those who have worked with us for years!

Assistance always available

Massima disponibilità di prodotti

Abbiamo a disposizione una delle più vaste gamme di articoli sul mercato ma riusciamo ad assicurare in ogni momento il 98% di disponibilità. Garantiamo che il restante 2% torni disponibile in 30 giorni!

We have one of the widest ranges of items on the market, but we can guarantee 98% availability at all times. We guarantee that the remaining 2% will be available in 30 days!

Maximum product availability

Spedizioni Veloci e sicure

Abbiamo sviluppato negli anni un sistema logistico efficiente in grado di garantire consegne in 24h per l'Italia e 48 per l'Europa, assicurando la massima cura nel trasporto. Un team multilingua è inoltre al servizio dei clienti per offrire supporto e assistenza.

Over the years, we have developed an efficient logistics system that guarantees deliveries within 24h in Italy and 48h in Europe, ensuring maximum care during transport. Our multilingual team also provides customers with support and assistance.

Quick and safe shipments

La qualità, al primo posto

Componenti di qualità, controlli multipli, collaudi in fase di realizzazione: per la qualità non scendiamo mai a compromessi. Grazie a un team di esperti riusciamo a garantire la tecnologia più avanzata, finiture ogni anno più curate e nuovi design a prova di tempo!

Quality components, multiple checks, testing during the manufacturing process: we never compromise on quality. With our team of experts, we can guarantee cutting-edge technology, new improved finishes every year and new designs that will stand the test of time!

Quality comes first

La gamma più completa di prodotti

Siamo una delle poche aziende al mondo a coprire così tanti settori di destinazione: dall'illuminazione industriale al prodotto decorativo. Siamo "appassionati ricercatori" e ogni anno arricchiamo la gamma con collezioni di tendenza e le innovazioni più efficienti in materia di tecnologia e sostenibilità.

We are one of the few companies in the world to cover so many target sectors: from industrial lighting to decor products. As "passionate researchers" every year we enrich our range with trend-setting collections and the most efficient innovations in terms of technology and sustainability.

The most comprehensive range of products

Illuminazione su misura

L'evoluzione stilistica e tecnologica dell'illuminazione ha indirizzato la ricerca illuminotecnica verso progetti di illuminazione su misura, in cui i corpi illuminanti sono strumenti al servizio del progetto architettonico. Questa fase evolutiva ci ha spinto ad ampliare la nostra divisione Project ed Illuminotecnica dedicata ai progetti su misura. La divisione esegue già servizi di progettazione, realizzazione prototipi, test e controllo di produzione per ogni prodotto presente sul nostro catalogo. Quando i prodotti non incontrano le esigenze del cliente, realizziamo prodotti "customizzati" su misura per le esigenze del progetto e per valorizzare al massimo gli ambienti del disegno illuminotecnico. Grazie a strumenti informatici e software di calcolo fotometrico possiamo fornire per ogni nuovo prodotto i calcoli fotometrici per un adeguato sviluppo progettuale illuminotecnico.

The stylistic and technological evolution of lighting has steered lighting research towards custom-made lighting projects, in which luminaires are used to support architectural design. This evolutionary phase encouraged us to expand our Project and Lighting department focusing on custom-made projects. The department already provides design, prototyping, testing and production monitoring services for all the products in our catalogue. When products don't meet the customer's needs, we make bespoke products to meet project requirements and fully enhance lighting design contexts. Using computer tools and photometric calculation software, we can provide photometric calculations for each new product thereby appropriately developing the lighting design project.

Custom-made lighting

SOSTENIAMO IL GREEN / WE ARE ECO-FRIENDLY

Abbiamo eliminato la plastica dai nostri packaging. Selezioniamo e prediligiamo materiali provenienti da risorse sostenibili. Ricerchiamo le tecnologie con miglior efficienza energetica abbinati a sistemi smart in grado di ridurre ulteriormente i consumi. Questi e molti altri sono i nostri impegni a sostegno della sostenibilità!

We no longer use plastic in our packaging. We select and prefer materials from sustainable resources. We research the most energy-efficient technologies combined with smart systems that further reduce consumption. All this, and much more, shows our commitment to sustainability!



GUIDA ALLA LETTURA DELLE TABELLE /
GUIDE TO READING THE TABLES

Ogni collezione è accompagnata da uno o più simboli per precisare la destinazione d'uso del prodotto
Every collection will be distinguished by a symbol for intended use

Nome e caratteristiche collezione
Collection name and characteristics



Certificazione e normative
Certification and regulations

Caratteristiche prodotto
Product characteristics

Codice prodotto e codice ean
Product code and EAN code

Potenza Power
Per i prodotti senza LED integrato, dati attacco lampadina con potenza massima certificata /
For the products without built-in LED max lamp holder power as required by CE certificate

Classe energetica
Energy class
ove esistente / where existing

Temperatura colore LED espressa in Kelvin + lumen
Colour temperature in Kelvin + lumen
ove esistente / where existing

Variante colore
Colour variance
ove esistente / where existing

Accessori
Accessories
ove esistente / where existing

Fotometria del prodotto
Photometric curve
ove esistente / where existing



indoor use

uso domestico / domestic use



outdoor use

esterno / outdoor use



accommodation areas use

strutture ricettive / accommodation areas use



office use

uffici / office use



commercial areas use

aree commerciali / commercial areas



urban areas use

aree urbane / urban use



industrial areas use

aree industriali / industrial use



bathroom use

ambiente bagno / bathroom use

APP INTEC GOOD SOLUTION FOR YOUR SMART LIFE!

EASY
DOMOTICA

WI-FI
SMART INTEC

SMART INTEC
BLUETOOTH
SIG MESH

Sistemi di controllo per i nostri prodotti SMART / Control system easy installation



Smart Intec WIFI



RF 2.4G control system



Alexa e Google Home voice control

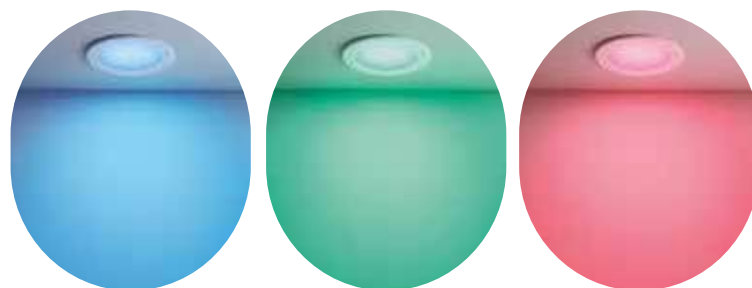

EASY DOMOTICA Con questo segmento tecnico intendiamo soddisfare al meglio la crescente esigenza di migliorare la qualità di vita domestica, e lavorativa attraverso l'utilizzo di dispositivi di illuminazione sempre più interconnessi fra loro tramite collegamenti sempre più semplificati dalle tecnologie wireless. I dispositivi di illuminazione diventano uno strumento estremamente personalizzato e modulabile che si fondono, anche in diversi momenti della giornata, con le evolute esigenze di illuminazione non più fine a se stessa ma adattata ai diversi umori sia di una utenza professionale che di una utenza domestica o ludica. Questa sezione raggruppa prodotti a bassa tensione che è possibile collegare con alimentatori a tensione costante in parallelo e si caratterizzano per la estrema flessibilità e modularità essendo essi compatibili con centraline di controllo in Radio Frequenza 2.4G, Infrarossi, Wifi o Bluetooth. Le centraline a loro volta prevedono interfacce wifi, bluetooth oppure possono essere controllate tramite wall pad o radiocomandi.

EASY DOMOTICA With this technical segment, we intend meet in the best way the growing need to improve the quality of home and working life through the use of lighting devices that are increasingly interconnected with each other through connections that are increasingly simplified by wireless technologies. The lighting devices become an extremely personalized and modular tool that merge, even at different times of the day, with the evolved lighting needs no longer as light source itself but light adapted to the different moods of both professional users, domestic users, playful users. This section groups low voltage products that can be connected with constant voltage power supply in parallel connection system and are characterized by extreme flexibility and modularity as they are compatible with 2.4G Radio Frequency, Infrared, Wifi or Bluetooth control units. The control units can be controlled by wifi, bluetooth devices or can be controlled via a wall pad or remote control.



È possibile controllare da remoto tutti gli apparecchi luminosi, con le APP INTEC e SMART LIFE / All luminaires can be remotely controlled with INTEC and SMART LIFE APPs.

Scarica l'app Smart Intec su / Download App Smart Intec on:



APP INTEC WI-FI Ogni momento della vita quotidiana richiede la giusta luce. Grazie all'illuminazione Smart, creare l'atmosfera ideale per tutti i momenti sarà possibile con i nostri prodotti Wi-fi e Bluetooth. Tramite la **nostra app Smart INTEC** è possibile comandare da remoto tutti gli apparecchi luminosi per accendere o spegnere, cambiare temperatura colore Kelvin della luce e anche impostare scene. Tra i nostri articoli troverai una selezione di prodotti a LED integrato pronti all'installazione ma anche tutti gli accessori necessari per rendere smart qualunque apparecchio domestico e non. Una volta collegata e scaricata l'app INTEC, la creazione delle varie stanze sarà semplice e intuitivo grazie alle istruzioni step by step. Per controllare i nostri prodotti smart è possibile anche utilizzare gli smart speaker e video Amazon e Google. Abilita la skill e controlla i dispositivi semplicemente parlando.

APP INTEC WI-FI Every moment of everyday life require the right light. Thank to the Smart lighting it will be possible to create the ideal atmosphere connecting them and controlling them thorough Wi-fi or Bluetooth connection. **With our APP Smart Intec** it is possible to control from remote all the lighting devices with on-off, kelvin colour temperature changing, light colour and scenes functions. To instore some smart lamps it is necessary just your standard home electric connection, and wifi connection. Once connected the lamp and downloaded the APP Smart Intec it will be very easy to create groups and rooms in very easy process thank to the instructions step by step on the App. The smart lamps can be controlled also with Wifi voice control devices.

SMART INTEC Bluetooth Sig Mesh La rete Bluetooth è stata ben accolta nell'illuminazione industriale, commerciale e domestica, in quanto uno dei sistemi di controllo dell'illuminazione intelligente più semplici e convenienti che svolge un ruolo chiave nel facilitare l'inter-dialogo tra i dispositivi di illuminazione. I nostri articoli Bluetooth Sig Mesh possono essere collegati con i dispositivi intelligenti tramite l'APP Smart Intec e ogni dispositivo di illuminazione può comunicare con un altro numero infinito di dispositivi attraverso la rete mesh entro una distanza di 15m per ogni dispositivo. La rete Mesh Bluetooth può essere controllata da remoto tramite Wifi grazie alla connessione del gateway Bluetooth il quale a sua volta può connettersi ai dispositivi voice control Alexa e Google. Per tutti gli utenti, i prodotti mesh Bluetooth sono anche comodi da usare. Abilitata da una rete di dispositivi su larga scala e in grado di sfruttare il basso consumo energetico, una rete mesh Bluetooth può supportare migliaia di dispositivi che lavorano contemporaneamente. Quindi, non importa se sei a casa o in ufficio, puoi sempre eseguire un gran numero di dispositivi intelligenti connessi allo stesso tempo. Di conseguenza, i prodotti Bluetooth mesh smart forniscono una gamma completa di comodità per vivere e lavorare senza preoccuparsi degli alti costi energetici. Nella casa intelligente, il Bluetooth abbassa la soglia di utilizzo dei dispositivi domestici intelligenti con il suo basso consumo energetico, l'elevata compatibilità e le caratteristiche di alta sicurezza, fornendo un'esperienza domestica più economica, più user-friendly e più intelligente. Senza l'autorizzazione dell'utente, il segnale Bluetooth non sarà in grado di connettersi e tracciare il dispositivo, proteggendo la privacy dell'utente.

SMART INTEC Bluetooth Sig Mesh Bluetooth mesh has been well received across the industrial, commercial and domestic lighting, as one of the easiest and much convenient smart lighting control systems playing a key role in facilitating the inter-dialogue between lighting devices. Our Bluetooth mesh items can be connected with the smart devices through the APP Smart Intec and each lighting device can communicate with other infinite number of devices through the mesh network with all other devices within a distance of 15m. The Bluetooth mesh network can be controlled from remote area through Wifi thank to the connection of Bluetooth gateway that can connect in turn to Alexa and Google voice controls. For individual users, Bluetooth mesh products are also convenient to use. Enabled by a large-scale device network and able to take advantage of low power consumption, a Bluetooth mesh network can support thousands of devices working simultaneously. So, no matter if you are at home or in the office, you can always run a large number of connected smart devices at the same time. As a result, Bluetooth mesh smart products provide a full range of conveniences for living and working without worrying about high energy costs. In the smart home, Bluetooth lowers the threshold of using smart home devices with its low power consumption, high compatibility, and high-security characteristics, providing a lower cost, more user-friendly, and smarter home experience. Without the user's permission, the Bluetooth signal will not be able to connect and track any device, protecting the user's privacy.









CARATTERISTICHE PRODOTTO / PRODUCT FEATURES

 LED SMD LED integrato SMD / Built-in SMD LED	 LED COB LED integrato COB / Built-in COB LED	 LED PERFORMANCE Prodotto ad alta efficienza luminosa / High luminous efficiency product	 RGB Prodotto RGB / RGB product	 CCT Prodotto CCT (bianco dinamico) / Adjustable white
--	--	---	---	--

 E12	 E14	 E27	 G9	 GU10	 GX53	 LED T8	 MR16	 R7s	 H49 Ø34	 H160 Ø57	 H115 Ø60
Attacco sorgente / Light source									Misura lampadina consigliata / Recommended bulb size		

 Selectable color temperature (3000K 4000K 6000K) Interruttore interno per la personalizzazione dei Kelvin / Internal switch for customization of Kelvin	 Selectable color temperature (3000K 4000K) Interruttore interno per la personalizzazione dei Kelvin / Internal switch for customization of Kelvin	 3 STEP MEMORY FUNCTION 3 step CCT Regolazione luce calda, naturale, fredda Memory function tramite interruttore a parete / Warm, natural and cold light control Memory function by means of a wall switch	 SWITCH TOUCH	 TOUCH CONTROL Interruttore touch integrato / Built-in touch switch
---	---	---	--	--





 Luce emergenza / Emergency light	 Prodotto ad energia solare / Solar energy product	 Calpestabile / Walkable max 2000kg	 IN&OUT Prodotto indoor e outdoor / Indoor e outdoor product	 Connessione bluetooth / Bluetooth connection
--	---	---	---	--

 TOUCH DIMMER Touch dimmer Intensità di luce regolabile / Dimmable light intensity	 Dimming Intensità di luce regolabile a taglio di fase / Adjustable light intensity by phase cut-out dimmer	 3 STEP DIM I prodotti 3 step dimmer permettono di regolare l'intensità luminosa utilizzando l'interruttore di casa / 3 step dimming function: modulation of light intensity by wall switch	 Touch step dimming Interruttore touch 3 luminosità / Step - 3 step brightness touch switch
---	--	--	--

 Gesso verniciabile / Gypsum paintable	 concrete finish Cemento / Concrete	 Prodotto galleggiante / Floating product	 Prodotto anticorrosione / Corrosion-free
---	--	--	--

 UGR <16	 UGR <19 Prodotto UGR / Unified glare rating UGR è un indice unificato in campo internazionale, sviluppato dalla CIE (commission international de l'Enclaireage), per la valutazione dell'abbagliamento diretto derivante dall'impianto di illuminazione. La norma europea per l'illuminazione dei posti di lavoro in interni UNI-EN 12464-1 richiede un valore UGR specifico per ogni applicazione, compreso tra 10 e 30: più basso è il valore, minore è l'abbagliamento.	 CRI 90	 CRI >80 Indice resa cromatica / Colour rendering index
--	--	--	---

UGR is an international unified data, developed by CIE (commission international de l'Enclaireage) for the avaluation of the glaning degree of the light sources. The European norme for the lighting of te specifical working place **UNI-EN 12464-1** requires a value UGR for every application, included between **10 and 30: lower is the value, lower is the anti glare ratee.**

 Incassi: direzione fascio di luce di luce asimmetrica / Recessed lamps: description of asymmetrical light emission type	 Plafoniere: direzione fascio di luce / Ceiling lamps: description of light emission type	 Applique: direzione fascio di luce / Wall lamps: description of light emission type	 Incassi e segnapassi: direzione fascio di luce / Inground and walk lights: description of light emission type
--	--	---	---

GRADI DI PROTEZIONE / IP PROTECTION RATE



Classe IP / IP Class

Tutti i prodotti presenti nel catalogo senza specifica grado IP si intendono IP20.

All items in the catalogue without IP rating specific are IP20.



Protezione da corpi solidi Protection against solid bodies

0
Nessuna protezione /
No protection

1
Protetto contro corpi solidi di dimensioni superiori a 50 mm /
Protected against solid bodies larger than 50 mm

2
Protetto contro corpi solidi di dimensioni superiori a 12 mm /
Protected against solid bodies larger than 12 mm

3
Protetto contro corpi solidi di dimensioni superiori a 2,5 mm /
Protected against solid bodies larger than 2,5 mm

4
Protetto contro corpi solidi di dimensioni superiori a 1 mm /
Protected against solid bodies larger than 1 mm

5
Protetto dalla polvere senza deposito dannoso /
Protected against dust no harmful deposit

6
Completamente protetto dalla polvere /
Completely protected against dust

Protezione da liquidi Protection against liquids

0
Nessuna protezione /
No protection

1
Protetto contro le gocce d'acqua a caduta verticale /
Protected against vertically-falling drops of water

2
Protetto contro le gocce d'acqua che cadono fino a 15° dalla verticale /
Protected against drops of water falling at up to 15° from the vertical

3
Protetto contro le gocce d'acqua che cadono fino a 60° dalla verticale /
Protected against drops of water falling at up to 60° from the vertical

4
Protetto contro le gocce d'acqua da tutte le direzioni /
Protected against projections of water from all directions

5
Protetto da getti d'acqua da tutte le direzioni /
Protected against jets of water from all directions

6
Protetto da getti d'acqua con una forte forza d'impatto /
Protected against jets of water of similar force heavy seas

7
Protetto dagli effetti dell'immersione /
Protected against the effects of immersion

8
Protetto contro gli effetti prolungati dell'immersione sotto pressione /
Protected against pro-longed the effects of immersion under pressure



Classe IK / IK Class

Gradi di protezione degli involucri per apparecchiature elettriche contro impatti meccanici esterni.

Degrees of protection for enclosures for electrical equipment against external mechanical impacts.

IK Energia d'impatto (in Joules) / Impact energy (in Joules)

00 0

01 0,15

02 0,2

03 0,35

04 0,5

05 0,7

06 1

07 2

08 5

09 10

10 20

Classe isolamento elettrico / Appliance class

Le classi di isolamento elettrico sono il raggruppamento omogeneo definito dall'IEC (International Electrotechnical Commission) delle caratteristiche tecniche applicabili ad un dispositivo elettrico per limitare i rischi di folgorazione conseguenti ad un guasto dello stesso.

The electrical insulation classes are the homogeneous grouping defined by the IEC (International Electrotechnical Commission) of the technical characteristics applicable to an electrical device to limit the risk of electrocution resulting from its failure.

I  Questi apparecchi devono avere il telaio collegato alla terra elettrica da un conduttore di terra separato /
These appliance must have their chassis connected to electrical earth by a separate earth conductor

II  Questi apparecchi sono progettati in modo da non richiedere la connessione delle messe a terra /
These appliance are designed in such a way that it does not require a safety connection to electrical earth

III  Questi apparecchi sono progettati per essere alimentati da una fonte di alimentazione a bassissima tensione separata di sicurezza /
These appliance are designed to be supplied from a separated/safety extra-low voltage power source

LEGENDA SIMBOLI / LEGEND OF SYMBOLS

Certificazione e normative / Certification and regulations

 Tutti i nostri prodotti sono certificati e conformi alle normative vigenti nella comunità Europea /
All our products comply with CE norms and current European standards

 EMC - Direttiva Europea sulla compatibilità elettromagnetica /
EMC - European electromagnetic compatibility directive

 Prodotto dimmerabile /
Product dimmable

 Prodotto non dimmerabile /
Product not dimmable

 DALI - Digital Addressable Lighting Interface Sistema di controllo domotico della luce /
DALI - Digital Addressable Lighting Interface Domestic lighting control system

 Dimensione foro quadrato per incasso a soffitto /
Square cut-out size for ceiling recessed lamps

 Dimensione foro rotondo per incasso a soffitto /
Round cut-out size for ceiling recessed lamps

 Dimensione foro quadrato per incasso a parete /
Square cut-out size for wall recessed lamps

 Dimensione foro rotondo per incasso a parete /
Round cut-out size for wall recessed lamps

Indoor:

- 033** SISTEMA BINARI /
TRACK LIGHTS
- 117** INCASSI /
RECESSED LAMPS
- 221** SISTEMI D'ILLUMINAZIONE
MULTIFUNZIONE /
MULTI-FUNCTION
LIGHTING SYSTEM
- 253** APPLIQUE E PLAFONIERE /
WALL LAMP AND CEILING LAMPS
- 373** SPOT E FARETTI /
SPOT LIGHTS
- 393** SOTTOPENSILI E BARRE LED /
CABINETS AND LEDBARS
- 419** PROFILI E STRIP LED /
PROFILES AND STRIP LED

Emergency:

- 461** LAMPADE D'EMERGENZA /
EMERGENCY LAMPS

Outdoor:

- 471** APPLIQUE /
WALL LAMPS
- 559** PLAFONIERE /
CEILING LAMPS
- 591** APPLIQUE, SOSPENSIONI
E PALETTI CORRELATI /
WALL, SUSPENSION AND
FLOOR LAMPS COMBINED
- 695** INCASSI E SEGNAPASSI /
INGROUND AND WALK LIGHTS
- 733** SOLARI /
SOLAR LAMPS
- 751** PROIETTORI /
FLOOD LIGHTS
- 781** STRADALI /
STREET LIGHTS

Industrial:

- 793** HIGH BAY & TRI-PROOF

















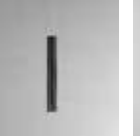

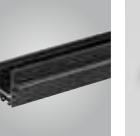









Decorative:

- 805** EASY DOMOTIC 24V /
- 815** LUCI DECORATIVE
TECNICHE DMX /
DMX TECHNICAL
DECORATION LIGHTING

Accessories:

- 835** COMPONENTISTICA /
LIGHTING COMPONENTS

Indoor:
SISTEMA BINARI /
TRACK LIGHTS

									
SHOT 46	GOAL 47	FANS 48	TEMA 50	LINE 52	SLIDE 54	TUBO 55	CYMBAL 56	DA VINCI accessories 58-63	BERNINI LINE 66
									
BERNINI FANS 68	BERNINI TUBO 69	BERNINI accessories 70	JET 76	EXPLORER 78	KONE 80-83	KONE FOOD 84	ACTION 86	ROCKET 88	ROCKET applique 89
									
SQUIB 90	EXPRESS 91	OBOE 92	CLOCK 93	MAXWELL 94	HELP TRACK 96	TRACK accessories 98-105	BUSBAR 110-113	BUSBAR accessories 114	

Indoor:
INCASSI /
RECESSED LAMPS

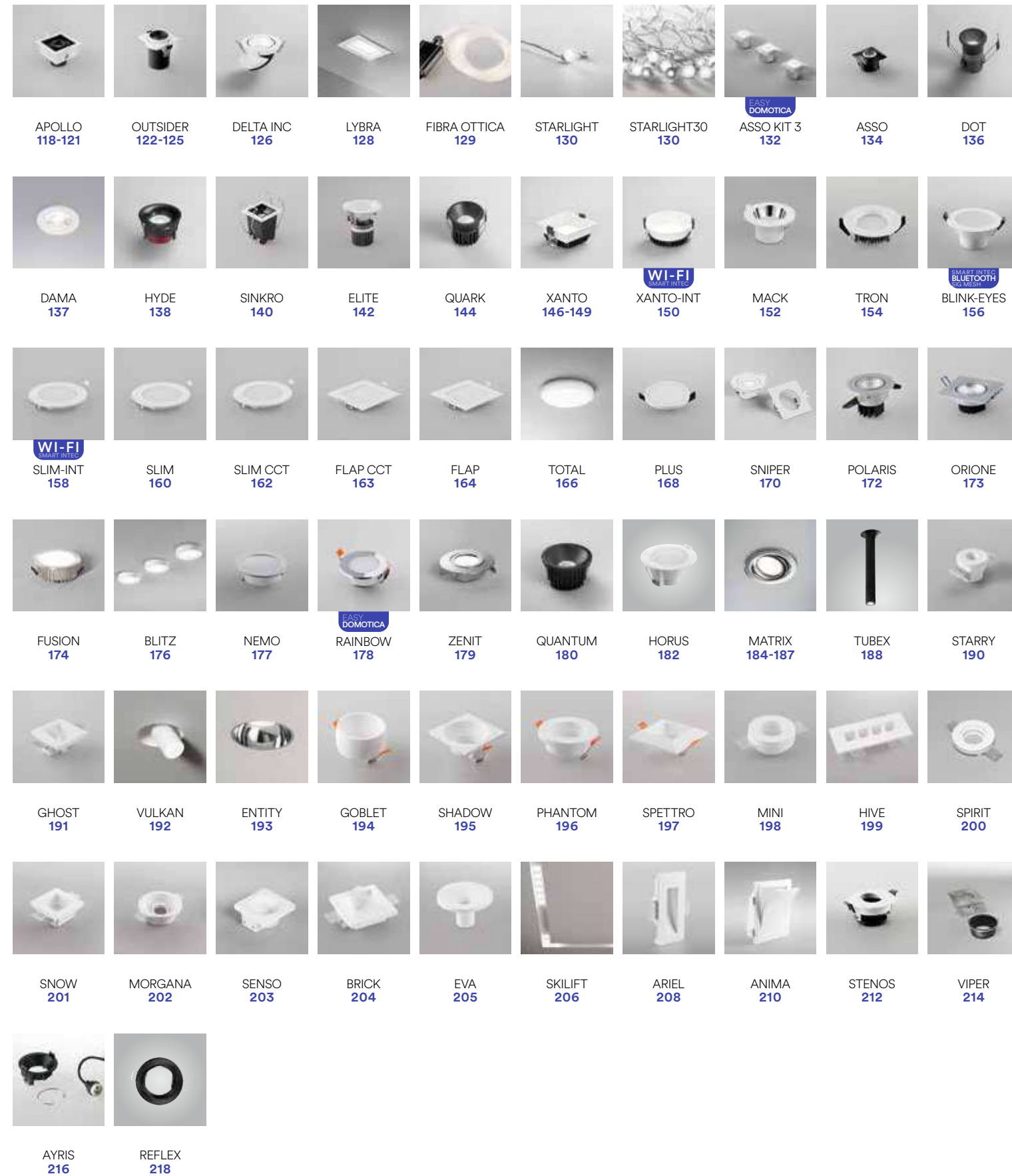

Indoor:
SISTEMI D'ILLUMINAZIONE MULTIFUNZIONE /
MULTI-FUNCTION LIGHTING SYSTEM

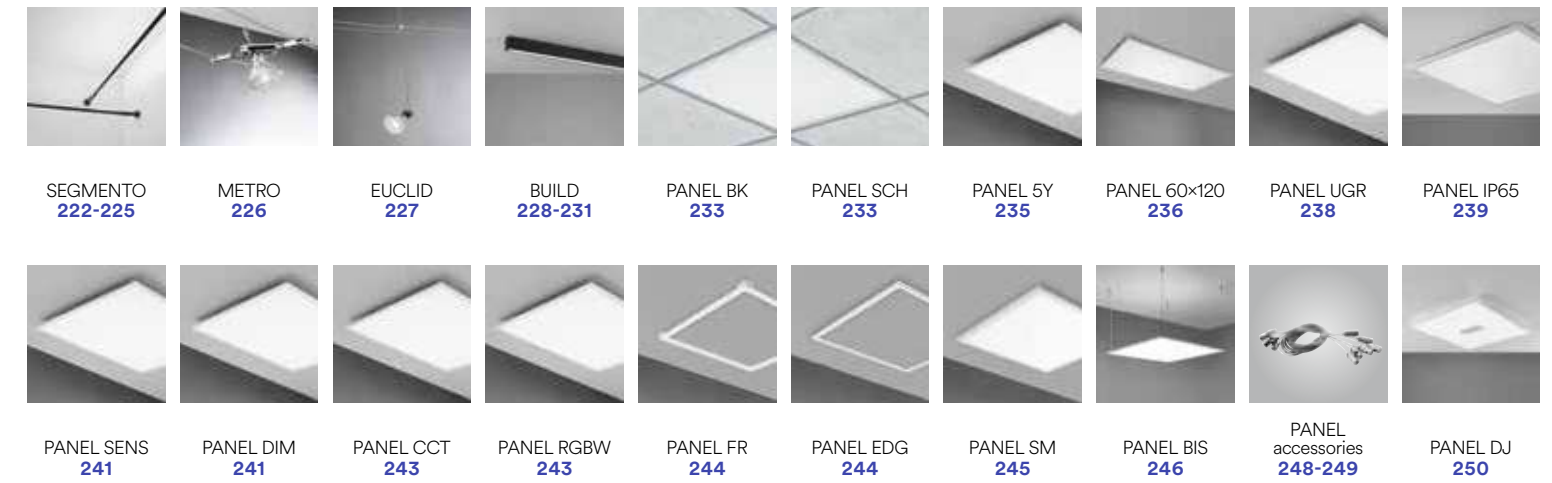

Indoor:
APPLIQUE E PLAFONIERE /
WALL LAMPS AND CEILING LAMPS

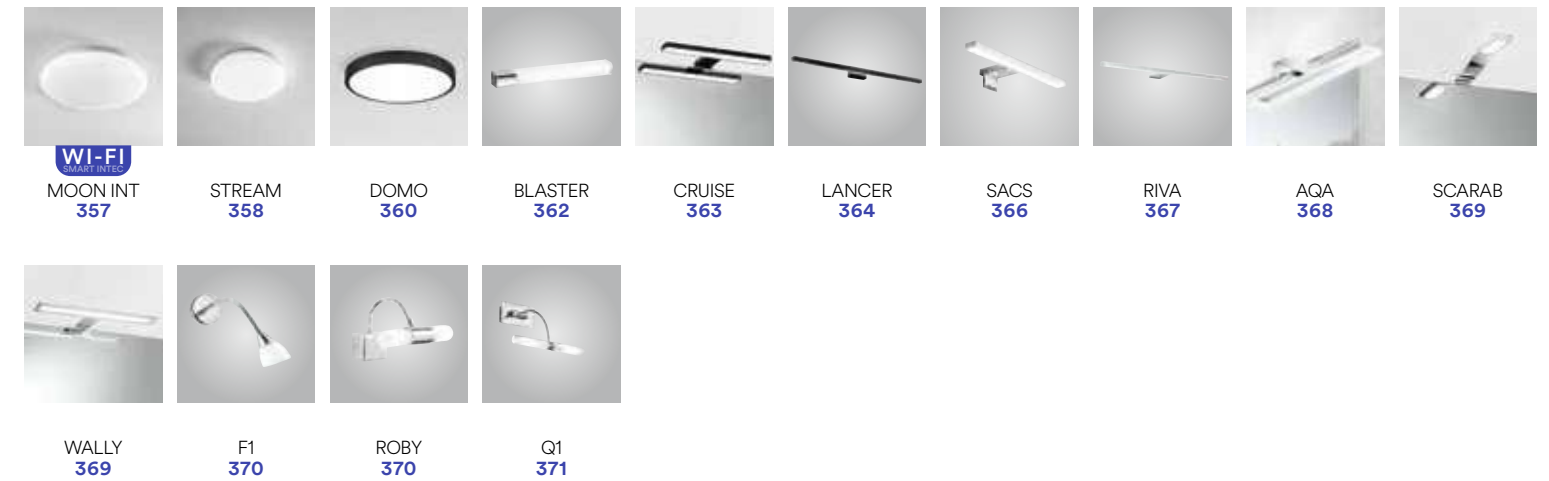
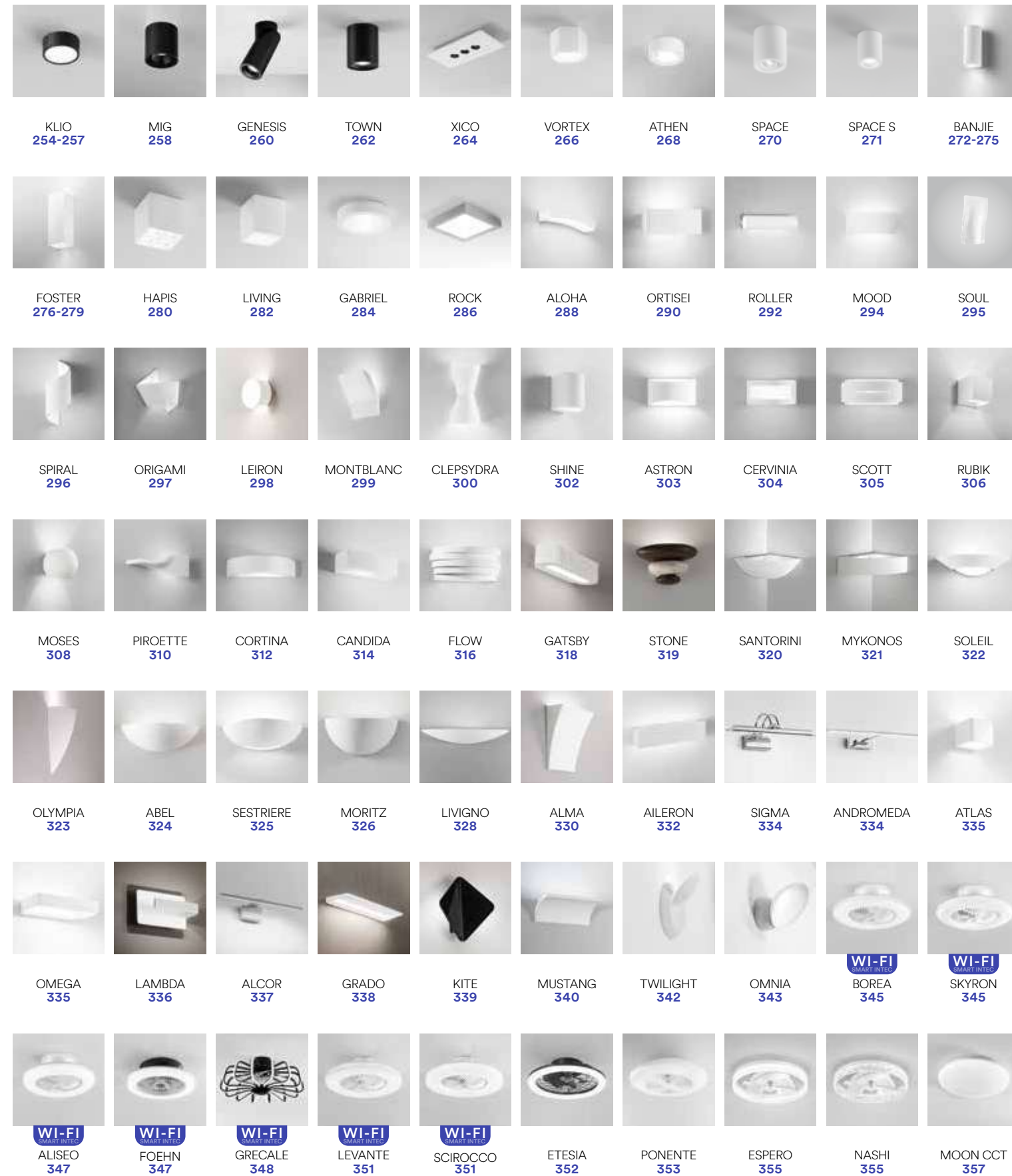

Indoor:
SPOT E FARETTI /
SPOT LIGHTS



Indoor:
SOTTOPENSILI E BARRE LED /
CABINETS AND LEDBARS

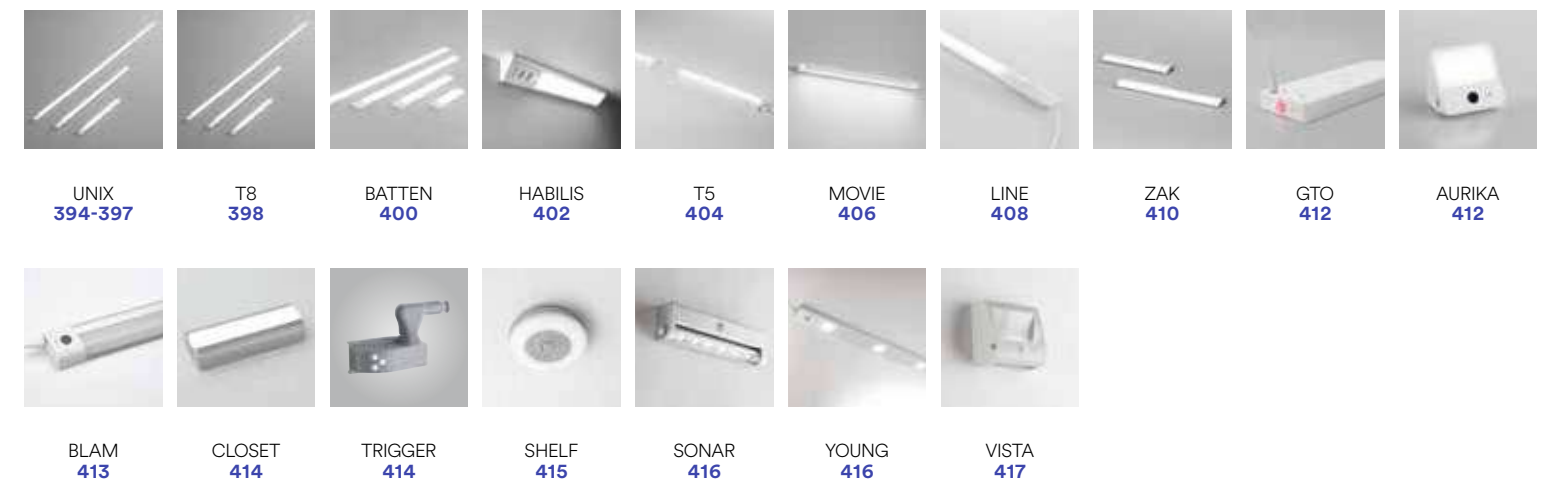

Indoor:
PROFILI E STRIP LED /
PROFILES AND STRIP LED

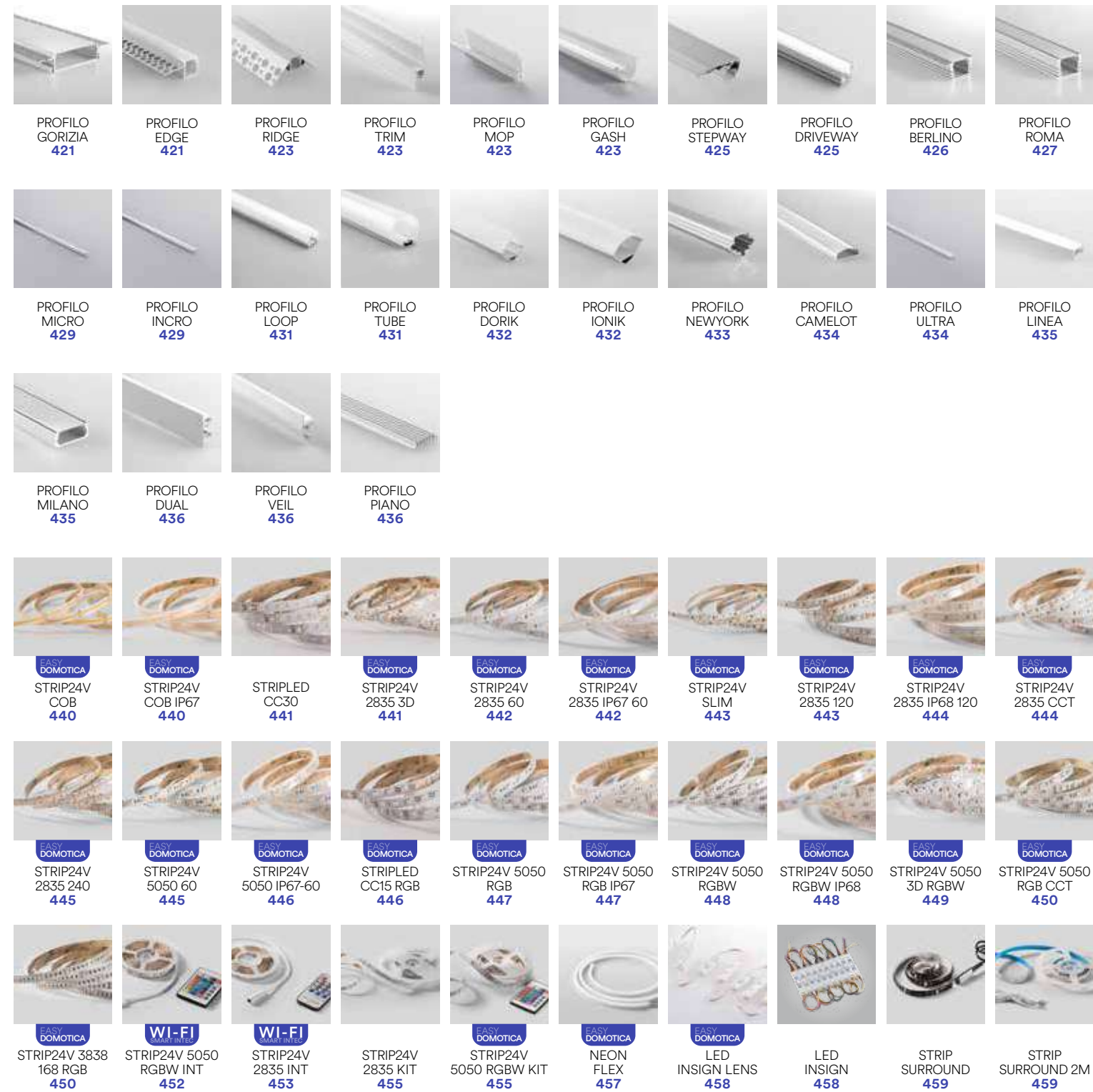

Indoor:
LAMPAD E D'EMERGENZA /
EMERGENCY LAMPS



Outdoor:
APPLIQUE /
WALL LAMPS

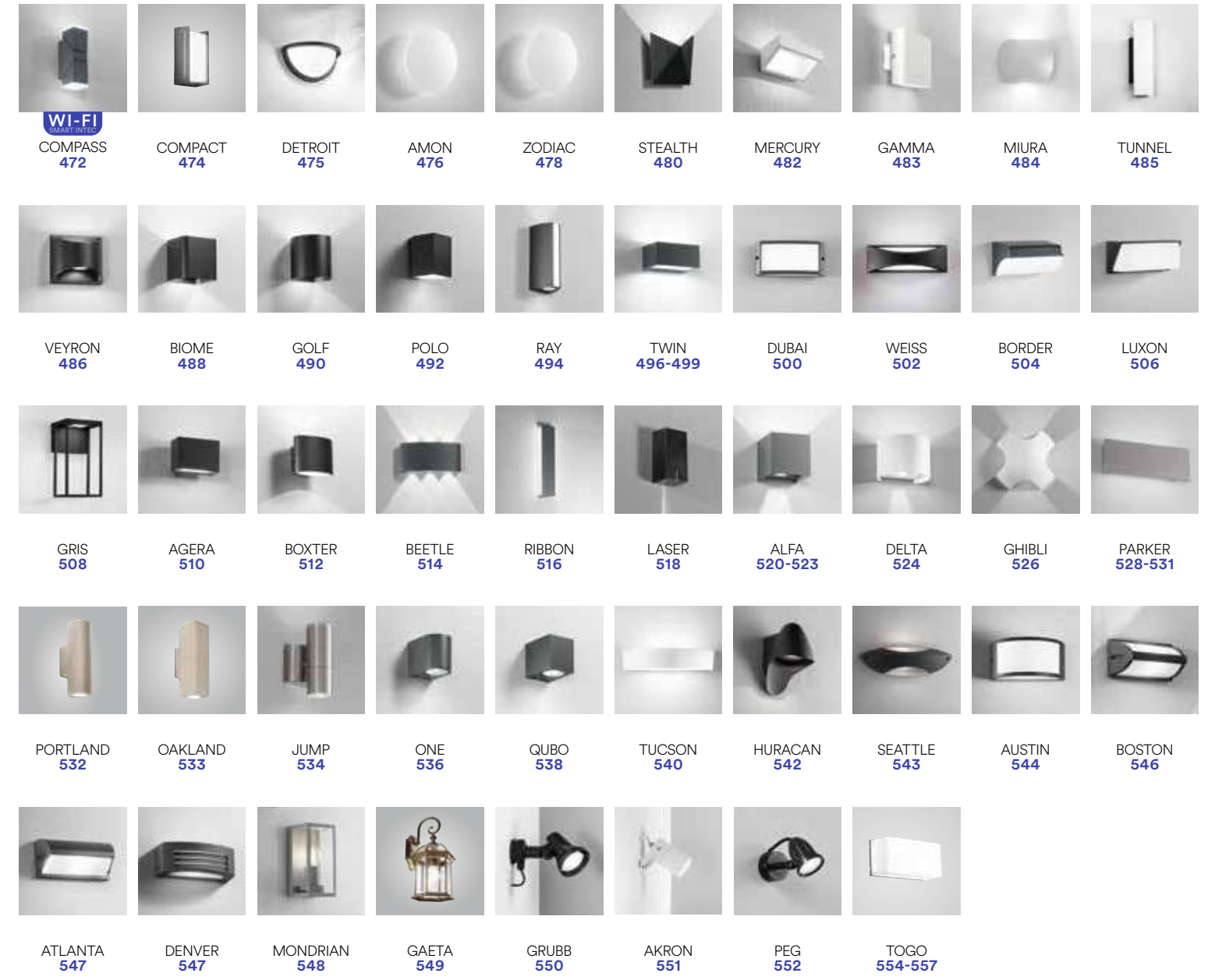

Outdoor:
PLAFONIERE /
CEILING LAMPS



Outdoor:
APPLIQUE SOSPENSIONI E PALETTI CORRELATI /
WALL SUSPENSION AND FLOOR LAMPS COMBINED



Outdoor:
INCASSI E SEGNAPASSI /
INGROUND AND WALK LIGHTS



Outdoor:
SOLARI /
SOLAR LAMPS



Outdoor:
PROIETTORI /
FLOOD LIGHTS



Outdoor:
STRADALI /
STREET LIGHTS



Industrial:
HIGH BAY & TRI-PROOF



Decorative:
EASY DOMOTIC 24V



Decorative:
LUCI DECORATIVE TECNICHE DMX /
DMX TECHNICAL DECORATION LIGHTING

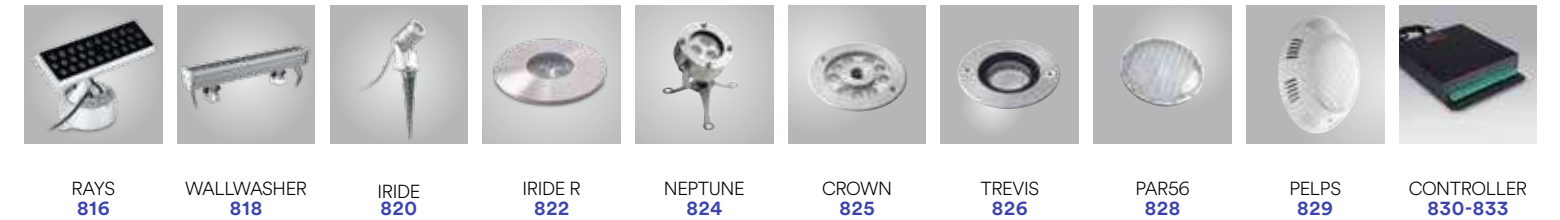

Accessories:
COMPONENTISTICA /
LIGHTING COMPONENTS

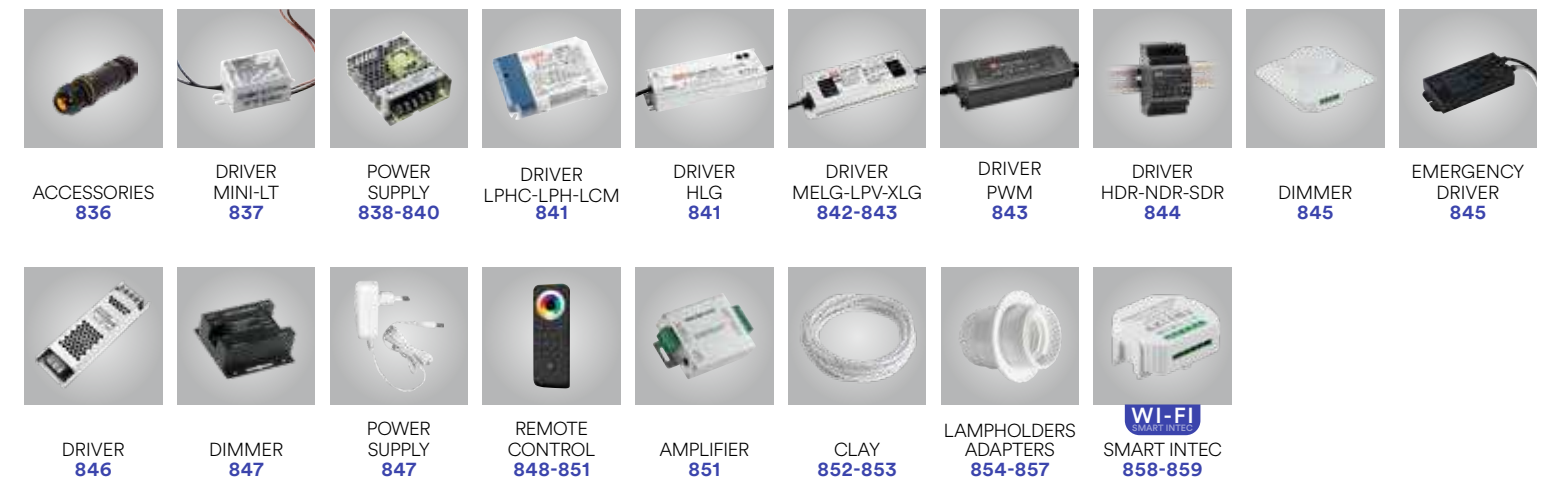

articolo / article pagina / page

ABEL	324
ACTION	86
AGERA	510
AILERON	332
AKRON	551
ALBERT	737
ALCOR	337
ALFA	520-523
ALISEO	347
ALMA	330
ALOHA	288
ALYSON	612
AMON	476
AMPLIFIER	851
ANDROMEDA	334
ANIMA	210
APOLLO	118-121
AQA	368
ARGO	745
ARIEL	208
ARTIC	800
ASSO	134
ASSO KIT 3	132
ASTRON	303
ATHEN	268
ATHOS	764
ATHOS SOLAR	748
ATLANTA	547
ATLANTIC	795
ATLAS	335
AURIKA	412
AUSTIN	544
AYRIS	216
BANJIE	272-275
BANNER	754
BARRET	696
BATTEN	400
BEETLE	514
BERNINI Accessories	70-71

articolo / article pagina / page

BERNINI FANS	68
BERNINI LINE	66
BERNINI Project 48V	64-65
BERNINI TUBO	69
BIOME	488
BITT	614
BLAM	413
BLASTER	362
BLINK-EYES	156
BLITZ	176
BOLT	726
BOLT HELP	467
BORDER	504
BOREA	345
BOSTON	546
BOXTER	512
BREEN	723
BRICK	204
BRIGHTMAX	692
BRIO	634
BUILD	228-231
BUSBAR	110-113
BUSBAR Accessories	114-115
BUSBAR Trunking system	106-109
CADILLAC	388
CANDIDA	314
CAPRI	569
CARRERA	390
CERVINIA	304
CITIZEN	566
CLAY	852-853
CLEPSYDRA	300
CLIMAX	640
CLOCK	93
CLOE	670
CLOSET	414
COCKTAIL	637

articolo / article pagina / page

COMPACT	474
COMPASS	472
CONCORDE	802
CONTROLLER	830-833
COOPER	386
CORTINA	312
COSMO	738-739
CROWN	825
CRUISE	363
CYMBAL	57
DAMA	137
DA VINCI Accessories	58-63
DA VINCI Project 48V	35-45
DELTA	524
DELTA INC	126
DENVER	547
DETROIT	475
DIMMER	845, 847
DISCOVERY	602-605
DOMO	360
DOT	136
DOUBLEU	390
DRINK	636
DRIVE	710
DRIVER	837, 841-846
DROP	626
DUBAI	500
ELIOS	760-763
ELIOS SOLAR	740
ELITE	142
ELMO	712
ENERGY	778
ENTITY	193
ENYA	735
EOS	741
ESPERO	355
ETERNA	462
ETESIA	352

articolo / article pagina / page

ETNA	628
EUCLID	227
EVA	205
EVER	578-581
EVER XL	582
EXPLORER	78
EXPRESS	91
EXTRA	572
F1	370
FANS	48
FEBO	785
FIBRA OTTICA	129
FIRENZE	682
FLAP	164
FLAP CCT	163
FLOW	316
FOEHN	347
FOSTER	276-279
FUSION	174
GABRIEL	284
GAETA	549
GAMMA	483
GATSBY	318
GECO DJ	644
GECO E27	648-655
GECO LED	646
GECO LED SOLAR	657
GENESIS	260
GHIBLI	526
GHOST	191
GIOVE	774
GOAL	47
GOBLET	194
GOLF	490
GRADO	338
GRECALE	348
GRIS	508
GROUND	714
GRUBB	550
GTO	412

articolo / article pagina / page

HABILIS	402
HAPIS	280
HELP 503	468
HELP 511	469
HELP EXIT	466
HELP INC	464
HELP TRACK Emergency lamps	465
HELP TRACK	96
HIGHWAY	788
HIVE	199
HORUS	182
HUMMER	708
HURACAN	542
HYDE	138
IDEM	606
IMPACT	701
INSIGN	458
INVICTUS	782
IPERION	784
IRIDE	820-823
ISCHIA	568
JAMMIN	632
JET	76
JUMP	534
KYOTO	734
KITE	339
KLIO	254-257
KONE	80-83
KONE FOOD	84
KRONOS	758
LAMBDA	336
LAMPHOLDER Accessories	854-855
LAMPHOLDER Adapters	856-857
LANCER	364
LASER	518
LEIRON	298
LEVANTE	351

articolo / article pagina / page

LINE	408
LINE DAVINCI	52
LIVIGNO	328
LIVING	282
LUXON	506
LYBRA	128
MACK	152
MANDALA	659
MASAI	630
MASTER	776
MATRIX	184-187
MAXWELL	94
MEGAN	674
MERCURY	482
METRO	226
MIAMI	384
MIG	258
MILANO	680
MINI	198
MIRAGE	662
MITO	388
MIURA	484
MONDRIAN	548
MONTBLANC	299
MOOD	294
MOON	356
MORGANA	202
MORITZ	326
MOSES	308
MOVIE	406
MUSTANG	340
MYKONOS	321
NASHI	355
NAUTILUS	798
NEMO	177
NEON FLEX	456
NEPTUNE	824
NISMO	616
OAKLAND	533
OBERON	643

articolo / article pagina / page

OBOE	92
OCEAN	801
OLYMPIA	323
OMEGA	335
OMNIA	343
ONE	536
ONYX	716
OPEN	742
ORBIT	666
ORIGAMI	297
ORIONE	173
ORTISEI	290
OUTSIDER	122-125
PANEL	236
PANEL 5Y	235
PANEL Accessories	248-249
PANEL BIS	247
PANEL BK	233
PANEL CCT	243
PANEL DIM	241
PANEL DJ	250
PANEL Easy domotic 24V	809
PANEL EDG	244
PANEL FR	244
PANEL IP65	239
PANEL RGB	243
PANEL SCH	233
PANEL SENS	241
PANEL SM	245
PANEL UGR	238
PAR56	828
PARKER	528-531
PAVIA	690
PEG	552
PELPS	829
PERRET	631
PHANTOM	196
PICNIC	586-587

articolo / article pagina / page

PICNIC COLOR	588
PICNIC INT	584
PIROETTE	310
PLUS	168
PLUTONE	766-769
POLARIS	172
POLIS	790
POLLY	592-597
POLO	492
PONENTE	353
PORTLAND	532
POWER SUPPLY	838-840, 847
PRISMA	668
PROFILE Accessories	437
PROFILE Aluminum	421-436
PROFILE Gypsum	438
PUNTO	376
Q1	371
QUANTUM	180
QUARK	144
QUBO	538
RAINBOW	178
RAY	494
RAYS	816
REFLEX	218
REMOTE CONTROL	848-851
REVERSE	608
RIBBON	516
RIDER	698
RIDER DIR	700
RIDER RGB	699
RIVA	367
ROBY	370
ROCK	286
ROCKET	88
ROCKET applique	89

articolo / article pagina / page

ROLLER	292
ROMA	676
RUBIK	306
RUNNER Easy domotic 24V	813
SACS	366
SANTIAGO	684
SANTORINI	320
SAT	756
SCARAB	369
SCIROCCO	351
SCOTT	305
SEATTLE	543
SEGMENTO	222-225
SENSITIVE	570
SENSO	203
SENSORS High bay & tri-proof	796
SENSORS Flood lights	773
SESTRIERE	325
SHADOW	195
SHELBY	730
SHELF	415
SHELLY	574-577
SHINE	302
SHIVA	746
SHOT	46
SIGMA	334
SINKRO	140
SINTESI	610
SKILIFT	206
SKITTLE	664
SKYP	743
SKYRON	345
SLAB	720
SLIDE	54
SLIM-INT	158
SLIM	160
SLIM CCT	162

articolo / article pagina / page

SMART HUB Smart Intec	858
SMART PLUG Smart Intec	858-859
SMART SENSOR Smart Intec	859
SMART SWITCH Smart Intec	859
SMILE	724
SNIPER	170
SNOW	201
SOLEIL	322
SONAR	416
SOUL	295
SPACE	270
SPETTRO	197
SPIRAL	296
SPIRIT	200
SPRINT Easy domotic 24V	812
SQUIB	90
STARGATE XP	794
STARLIGHT	130
STARLIGHT30	130
STARRY	190
STATION	619
STEALTH	480
STENOS	212
STEP	702
STEPLIGHT	728
STONE	319
STRATOS	718
STREAM	358
STREETWAY	786
STRIP24V 2835 3D 60	441
STRIP24V 2835 60	442
STRIP24V 2835 120C	443
STRIP24V 2835 240	445
STRIP24V 2835 CCT	444
STRIP24V 2835C INT	453

articolo / article pagina / page

STRIP24V 2835C KIT	455
STRIP24V 2835 IP68 120	444
STRIP24V 3838 168 RGB	450
STRIP24V 5050 3D RGBW	449
STRIP24V 5050 60	445
STRIP24V 5050 60 IP67	446
STRIP24V 5050 RGB	447
STRIP24V 5050 RGB CCT	450
STRIP24V 5050RGB KIT	455
STRIP24V 5050 RGBW	448
STRIP24V 5050RGBW INT	452
STRIP24V COB	440
STRIP24V SLIM 120	443
STRIPLED CC	441
STRIPLED CC15 RGB	446
STRIP SURROUND	459
STRIP Easy domotic 24V	810
SUBWAY	697
SUNNY	382
SUPERIA	803
T5	404
T8	398
TARGET Easy domotic 24V	811
TAURUS	770
TECHNO	378-381
TED	736
TEMA	50
TOGO	554-557
TOKYO	622-625
TOTAL	166
TOWN	262
TRACK Accessories	98-105
TRACK Three-phase	72-75
TREVIS	826
TRIGGER	414
TRON	154

articolo / article pagina / page

TUBEX	188
TUBO	55
TUCSON	540
TUNNEL	485
TUTOR	562
TWILIGHT	342
TWIN	496-499
ULYSSE	747
UNDERWOOD	620
UNIX	394-397
VENEZIA	688
VERTIGO	564
VEYRON	486
VIPER	214
VISTA	417
VORTEX	266
VULKAN	192
VYSOR	752
WALK	704-707
WALLWASHER	818
WALLY	369
WAMI	600
WEISS	502
WIZARD	598
XANTO-INT	150
XANTO-RF Easy domotic 24V	808
XANTO	146-149
XICO	264
YORK	661
YOUNG	416
ZAK	410
ZENIT	179
ZERO	374
ZODIAC	478
ZOOM	560



SISTEMA BINARI

TRACK LIGHTS

DA VINCI
PROJECT
48V



DA VINCI PROJECT 48V

INTEC fa un salto nel futuro con il sistema Da Vinci, sistema progettato per integrarsi totalmente con l'architettura degli ambienti. Esso può essere fissato al soffitto o alle pareti, inserito nella muratura ad incasso a filo oppure nella versione a sospensione con luce bi-emissione.

Frutto della ricerca tecnologica più avanzata, il sistema consente di creare luce che scaturisce direttamente dalle pareti o dal soffitto, e gioca con gli spazi abitativi tracciando segni luminosi che variano a seconda della posizione del corpo illuminante, posizione che può essere modificata con la massima versatilità in ogni momento grazie al semplice inserimento dei corpi illuminanti all'interno del binario tramite il fluido sistema di innesti a sfere volventi.

INTEC leap forward into the future with the Da Vinci system, system designed to fully integrate with the architecture environments. It can be fixed to the ceiling or to the walls, inserted in the flush-mounted masonry or mounted in suspension version with single or bi-emission light.

Fruit of most advanced technological research, the system allows you to create light that springs directly from the walls or ceiling, and plays with living spaces by drawing luminous signs that vary according to the position of the luminaire, position which can be modified with maximum versatility at any time thanks to the simple insertion of the led luminous bodies inside the track by means of the fluid ball bearings.

A
**RECESSED
TRACK TRIMLESS**

Sistema di montaggio a incasso a filo / Recess mount system trimless

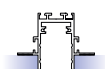

B
**RECESSED
TRACK**

Sistema di montaggio a incasso con cornice / Recess mount system with external trim

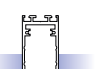

C
**SURFACE
MOUNTED**

Sistema di montaggio a plafoniera o a sospensione a vista / Ceiling or suspension mounting system

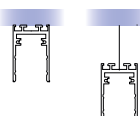

D
PENDANT

Sistema di montaggio a sospensione bi-emissione / Bi-emission suspension mounting system

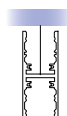

DA VINCI PROJECT 48V



In base allo spazio da illuminare, è possibile aggiungere, rimuovere o orientare gli apparecchi, quando e dove necessario grazie ad un semplice click. Il sistema Da Vinci a sfere volventi è basato sul sistema plug & play, non ha quindi bisogno di complessi interventi tecnici. Ogni corpo illuminante Da Vinci ha solo bisogno di essere posizionato, inserito ed acceso.

Depending on the space to be illuminated, it is possible to add, remove or orient the appliances when and where necessary thanks to a simple click. The Da Vinci rolling ball system is based on the system plug & play, therefore it does not need complex interventions of technicians. Every Da Vinci luminaire just needs to be positioned, inserted and switched on.

All'interno del binario Da Vinci si può operare con inserimento di una vasta gamma di moduli di illuminazione decorativa sia con fari a spot orientabili, lampade sospese, che con lampade a led lineari fisse o mobili.

Inside the track Da Vinci can be inserted a wide range of decorative lighting modules with headlights, adjustable spots, suspended lamps, and with led linear lamps fixed or movable.

A
LINE

Lampada lineare orientabile a led / Led adjustable linear lamp

B
SLIDE

Lampada lineare orientabile a led / Led adjustable linear lamp

C
GOAL

Faro luce spot orientabile / Spot orientable track light

D
SHOT

Faro luce spot orientabile / Spot orientable track light

E
FANS

Faro luce spot orientabile / Spot orientable track light

F
TEMA

Faro luce spot orientabile / Spot orientable track light

G
CYMBAL

Lampada sospensione led / Suspension led light

H
TUBO

Lampada sospensione led / Suspension led light



DA VINCI PROJECT 48V

Il binario Da Vinci è un binario completamente elettrificato a bassa tensione e si completa con elementi luminosi a led inseribili semplicemente con un click, grazie all'incastro a sfere volventi, lungo tutto il percorso.
La diversificata gamma di corpi illuminanti Da Vinci, e la ampia scelta di forme, angoli e connessioni permettono la realizzazione di disegni illuminotecnici che esprimono la massima dinamicità e poliedricità delle personalizzazioni.

Da Vinci track is a fully electrified low voltage track system and it is completed with led light elements which can be inserted simply with a click, thanks to the joint a rolling spheres, all along the path.
The diversified range of lighting fixtures Da Vinci, and the wide choice of shapes, angles and connections allow the creation of lighting designs which express the maximum dynamism and versatility of the customizations.

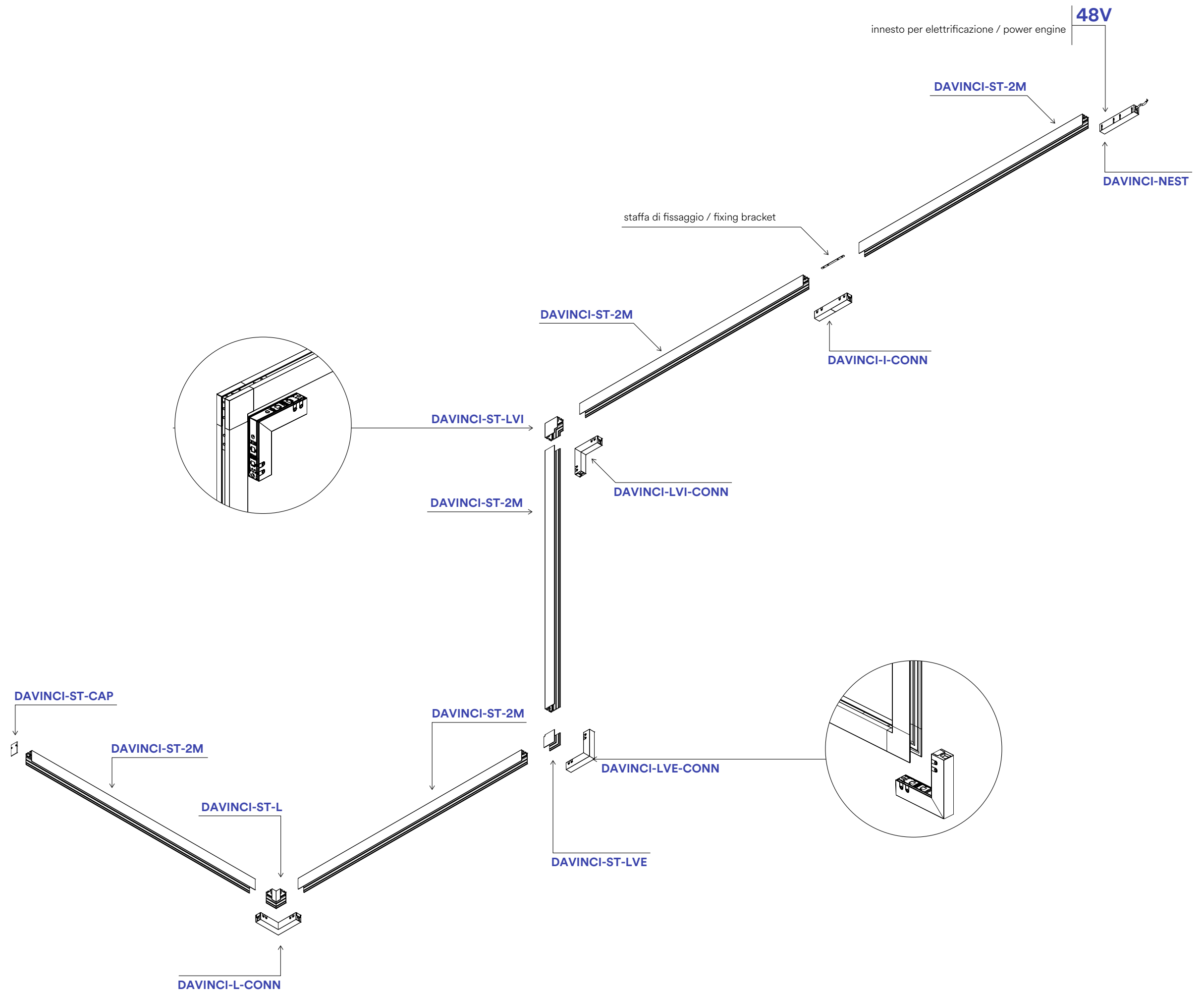

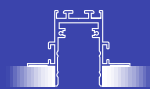

on photo:
TUBO / FANS
Recess mount system trimless

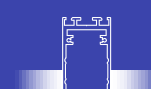

on photo:
CYMBAL / TEMA
Recess mount system with external trim

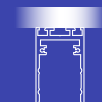

on photo:
CYMBAL / GOAL
Ceiling or suspension mounting system





on photo:
LINE UGR / LINE / TEMA
Ceiling or suspension mounting system



on photo:
SHOT / LINE URG / LINE / SLIDE
Biemission suspension mounting system

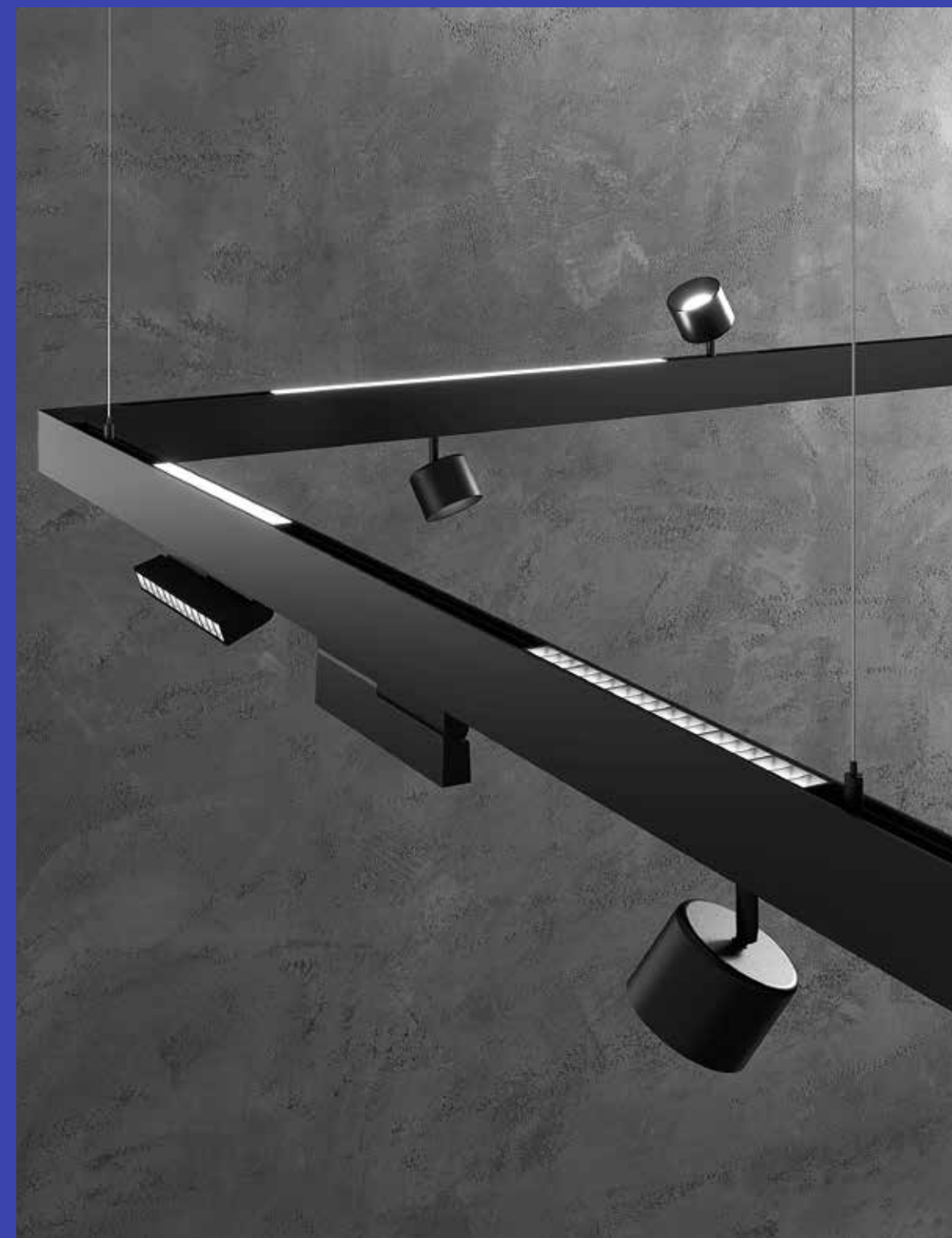

Da Vinci Project 48V
Sfere volventi / Rolling spheres

SHOT

Proiettore a binario con luce spot orientabile per sistema Davinci con struttura in alluminio pressofuso.
Track headlamp with adjustable spot light for Davinci system with die-cast aluminum structure.

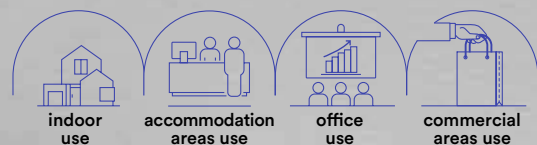

Materiale
alluminio

Colore
nero gofrato



Temperatura colore
3000K / 4000K



Driver
DC 48V
non incluso

Material
aluminum

Colour
embossed black



Colour temperature
3000K / 4000K



Driver
DC 48V
not included

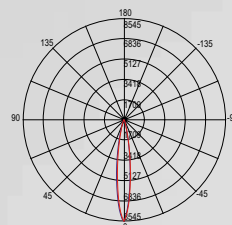

DAVINCI-SHOT-B

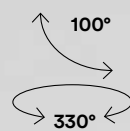

	colour temp.	colour
DAVINCI-SHOT-B-10C 8031414893911 lumen	980 lm	
DAVINCI-SHOT-B-10M 8031414893928 lumen	980 lm	
watt	10W	
beam angle	24°	

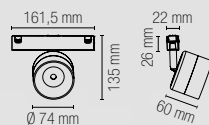

Da Vinci Project 48V
Sfere volventi / Rolling spheres

GOAL

Proiettore a binario con luce spot orientabile per sistema Davinci con struttura in alluminio pressofuso.
Track headlamp with adjustable spot light for Davinci system with die-cast aluminum structure.

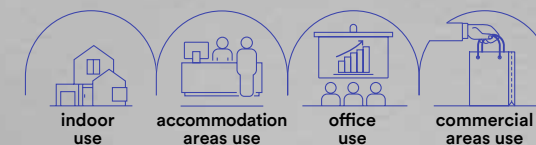

Materiale
alluminio

Colore
nero gofrato



Temperatura colore
3000K / 4000K



Driver
DC 48V
non incluso

Material
aluminum

Colour
embossed black



Colour temperature
3000K / 4000K



Driver
DC 48V
not included

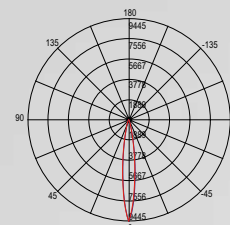

DAVINCI-GOAL-B



	colour temp.	colour
DAVINCI-GOAL-B-10C 8031414893935 lumen	980 lm	
DAVINCI-GOAL-B-10M 8031414893942 lumen	980 lm	
watt	10W	
beam angle	24°	

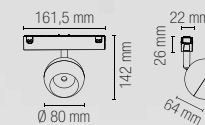

SISTEMA BINARI / TRACK LIGHTS
In.tec light

FANS

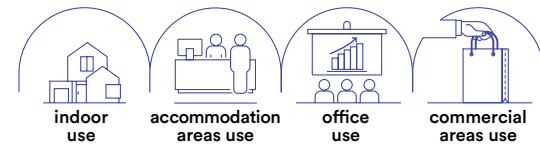

Materiale
alluminio

Colore
bianco opaco
nero opaco
oro



Temperatura colore
3000K / 4000K



Driver
DC48V
non incluso

Material
aluminum

Colour
matt white
matt black
gold



Colour temperature
3000K / 4000K



Driver
DC48V
not included

Proiettore a binario con luce spot orientabile per sistema Davinci con struttura in alluminio pressofuso.
Track headlamp with adjustable spot light for Davinci system with die-cast aluminum structure.

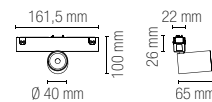

	colour temp.	colour
DAVINCI-FANS-W-5C 8031414893874	3000K	white
DAVINCI-FANS-W-5M 8031414893881	4000K	white
lumen	490 lm	
DAVINCI-FANS-B-5C 8031414893850	3000K	black
DAVINCI-FANS-B-5M 8031414893867	4000K	black
lumen	490 lm	
DAVINCI-FANS-G-5C 8031414893898	3000K	gold
DAVINCI-FANS-G-5M 8031414893904	4000K	gold
lumen	490 lm	
watt	5W	
beam angle	24°	

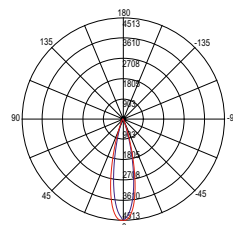

DAVINCI-FANS



TEMA

Proiettore a binario con luce spot orientabile per sistema Davinci con struttura in alluminio pressofuso. Diffusore in vetro trasparente.

Track projectors with adjustable spot light for Davinci system with die-cast aluminium structure. Diffuser in clear glass.

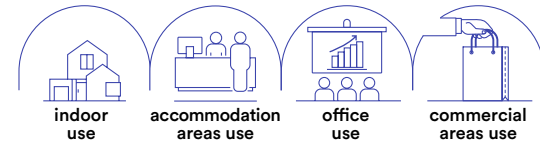

technical information **TEMA**



Accessori non inclusi / Not included accessories

Materiale

corpo in alluminio pressofuso

Colore

bianco opaco
nero opaco



Temperatura colore

3000K / 4000K



Driver

DC48V non incluso

Material

aluminum die cust body

Colour

matt white
matt black



Colour temperature

3000K / 4000K



Driver

DC48V not included

Retina antiabbagliamento /
Anti-glare retina



LED-KONE-MESH62 8031414870455	per/for	10W
LED-KONE-MESH80 8031414870462	per/for	20W
LED-KONE-MESH100 8031414870431	per/for	30W

Deviatore flusso luminoso /
Luminous flux diverter



LED-KONE-DIFF62 8031414870448	per/for	10W
LED-KONE-DIFF80 8031414870417	per/for	20W
LED-KONE-DIFF100 8031414870424	per/for	30W

	colour temp.	colour
DAVINCI-TEMA-5C 8031414876976	490 lm	
DAVINCI-TEMA-5M 8031414876983	490 lm	
watt		5W
beam angle		38°

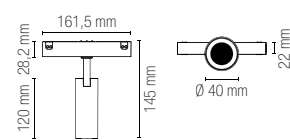

	colour temp.	colour
DAVINCI-TEMA-W-10C 8031414894031	1200 lm	
DAVINCI-TEMA-W-10M 8031414894048	1200 lm	
DAVINCI-TEMA-10C 8031414876990	1200 lm	
DAVINCI-TEMA-10M 8031414878215	1200 lm	
watt		10W
beam angle		38°

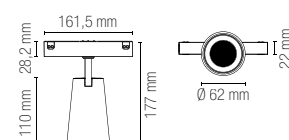

Accessori inclusi / Included accessories



Kit 2pz fermi per corpi illuminanti sistema con sfere volventi /
Kit 2pcs of side brake for Davinci light source modules with rolling spheres joint system

	colour temp.	colour
DAVINCI-TEMA-W-20C 8031414894055	1930 lm	
DAVINCI-TEMA-W-20M 8031414894062	1930 lm	
DAVINCI-TEMA-20C 8031414878222	1930 lm	
DAVINCI-TEMA-20M 8031414878239	1930 lm	
watt		20W
beam angle		38°

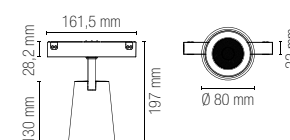

Accessori inclusi / Included accessories



Kit 2pz fermi per corpi illuminanti sistema con sfere volventi /
Kit 2pcs of side brake for Davinci light source modules with rolling spheres joint system

	colour temp.	colour
DAVINCI-TEMA-W-30C 8031414894079	3210 lm	
DAVINCI-TEMA-W-30M 8031414894086	3210 lm	
DAVINCI-TEMA-30C 8031414878246	3210 lm	
DAVINCI-TEMA-30M 8031414878253	3210 lm	
watt		30W
beam angle		38°

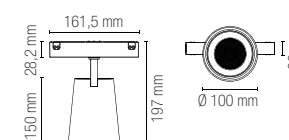

Accessori inclusi / Included accessories



Kit 2pz fermi per corpi illuminanti sistema con sfere volventi /
Kit 2pcs of side brake for Davinci light source modules with rolling spheres joint system

Fotometria del prodotto / Photometric curve

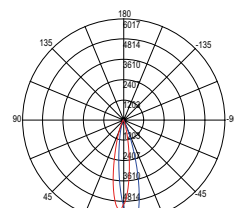

DAVINCI-TEMA-5

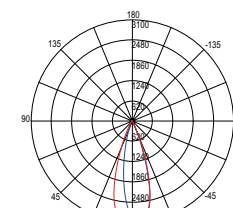

DAVINCI-TEMA-10

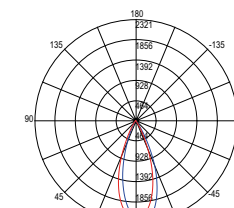

DAVINCI-TEMA-20

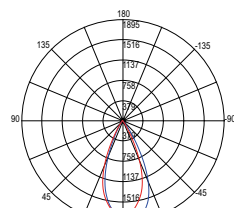

DAVINCI-TEMA-30

LINE

Lampada lineare a LED per sistema Davinci con struttura in alluminio pressofuso e finitura in nero goffrato. Disponibile in varie misure.

LED linear lamp for Davinci system with die-cast aluminum structure and embossed black finish. Available in various sizes.

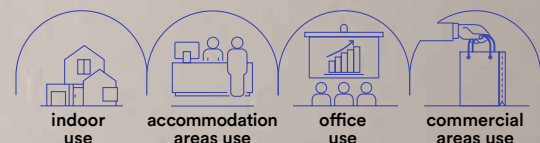

technical information **LINE**



UGR <19

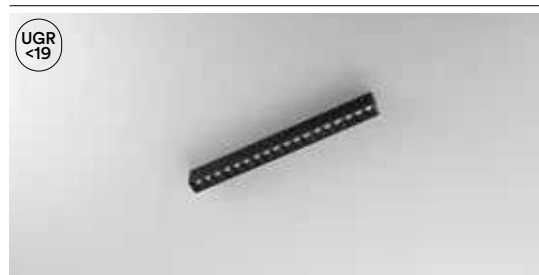

DAVINCI-LINE30C-UGR

8031414878321

lumen

colour temp.



1200 lm

colour

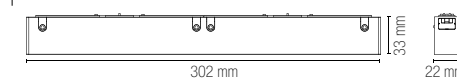

DAVINCI-LINE30M-UGR

8031414878338

lumen

1200 lm

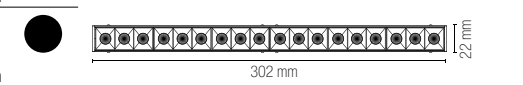

watt

10W

beam angle

30°

Materiale

corpo in alluminio pressofuso

Colore

nero



Temperatura colore

3000K / 4000K



Driver

DC48V non incluso

Material

aluminum die cast body

Colour

black



Colour temperature

3000K / 4000K



Driver

DC48V not included



DAVINCI-LINE30C

8031414878260

lumen

colour temp.



1150 lm

colour

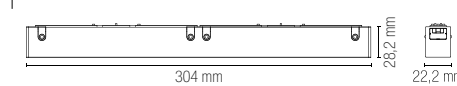

DAVINCI-LINE30M

8031414878277

lumen

1150 lm

110°

watt

10W

beam angle

110°



DAVINCI-LINE60C

8031414878284

lumen

colour temp.

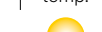

2300 lm

colour



DAVINCI-LINE60M

8031414878291

lumen

2300 lm

110°

watt

20W

beam angle

110°



DAVINCI-LINE90C

8031414878666

lumen

colour temp.

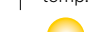

3450 lm

colour

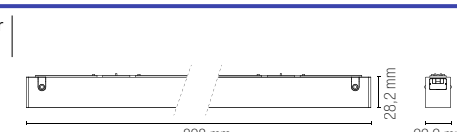

DAVINCI-LINE90M

8031414878635

lumen

3450 lm

110°

watt

30W

beam angle

110°



DAVINCI-LINE120C

8031414878642

lumen

colour temp.



4600 lm

colour

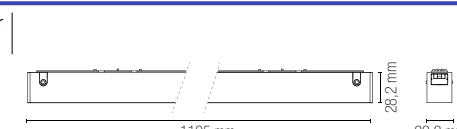

DAVINCI-LINE120M

8031414878611

lumen

4600 lm

110°

watt

40W

beam angle

110°

Fotometria del prodotto / Photometric curve

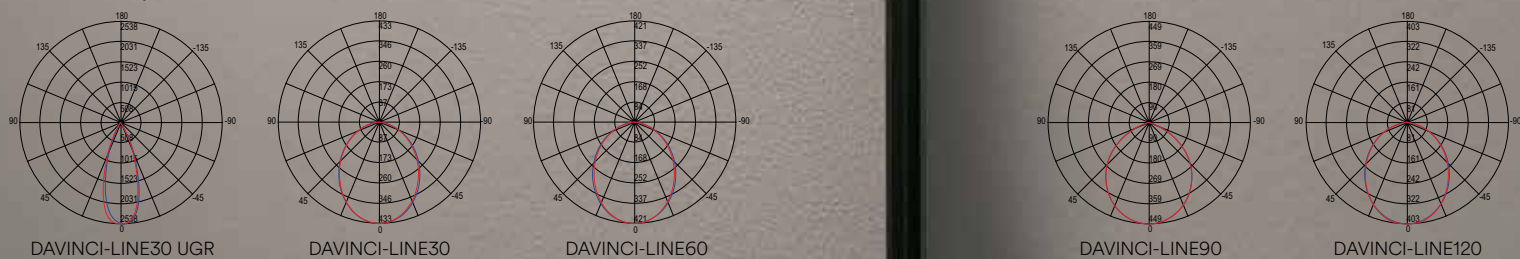

DAVINCI-LINE30 UGR

DAVINCI-LINE30

DAVINCI-LINE60

DAVINCI-LINE90

DAVINCI-LINE120

SLIDE

Lampada lineare orientabile a LED per sistema Davinci con struttura in alluminio pressofuso.
LED adjustable linear lamp for Davinci system with die-cast aluminum structure.

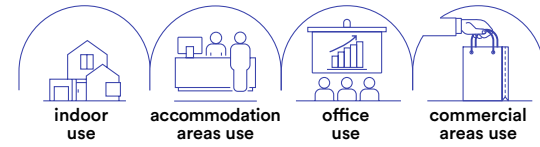

TUBO

Sospensioni tubolari a LED per sistema Davinci con struttura in alluminio pressofuso.
LED tubular suspensions for Davinci system with die-cast aluminum structure.

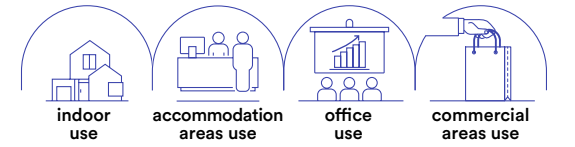

	colour temp.	colour
DAVINCI-W-S35C 8031414894093 lumen		
	300 lm	
DAVINCI-W-S35M 8031414894109 lumen		
	300 lm	
DAVINCI-S35C 8031414878390 lumen		
	300 lm	
DAVINCI-S35M 8031414878406 lumen		
	300 lm	
DAVINCI-G-S35C 8031414894116 lumen		
	300 lm	
DAVINCI-G-S35M 8031414894123 lumen		
	300 lm	
watt		3W
beam angle		24°

	colour temp.	colour
DAVINCI-S60C 8031414878680 lumen		
	500 lm	
DAVINCI-S60M 8031414878659 lumen		
	500 lm	
watt		5W
beam angle		24°

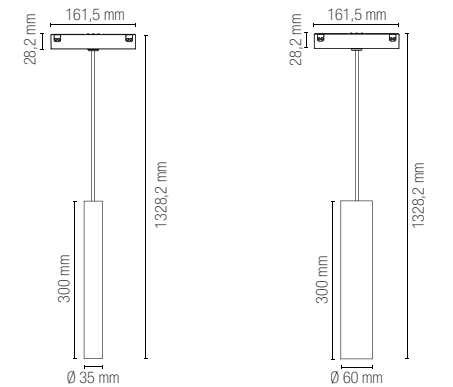

Fotometria del prodotto / Photometric curve



Materiale
corpo in alluminio pressofuso

Colore
bianco opaco
nero opaco



Temperatura colore
3000K / 4000K



Driver
DC48V non incluso

Material
aluminum die cast body

Colour
matt white
matt black



Colour temperature
3000K / 4000K



Driver
DC48V not included

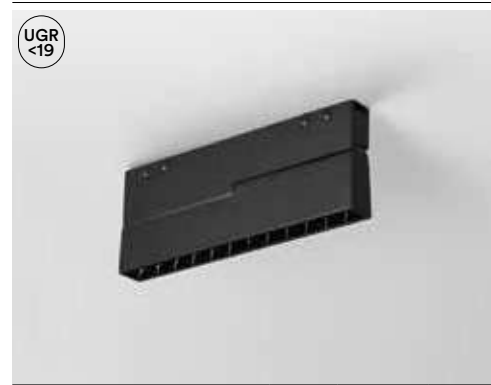

	colour temp.	colour
DAVINCI-SLIDE20C-UGR 8031414878369 lumen		
	1020 lm	
DAVINCI-SLIDE20M-UGR 8031414878376 lumen		
	1020 lm	
watt		10W
beam angle		30°

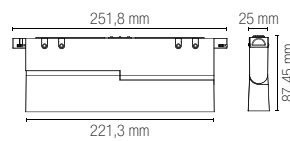

	colour temp.	colour
DAVINCI-SLIDE20C 8031414878345 lumen		
	980 lm	
DAVINCI-SLIDE20M 8031414878352 lumen		
	980 lm	
watt		10W
beam angle		110°

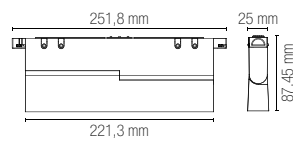

Fotometria del prodotto / Photometric curve

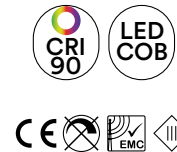
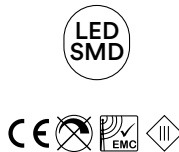



Da Vinci Project 48V
Sfere volventi / Rolling spheres

CYMBAL

Lampada a sospensione
LED in alluminio
per sistema a binario.
Aluminum LED suspension
lamp for track system.

Materiale
alluminio

Colore
bianco opaco
nero opaco



Temperatura colore
3000K / 4000K



Driver
DC 48V
non incluso

Material
aluminum

Colour
matt white
matt black



Colour temperature
3000K / 4000K



Driver
DC 48V
not included

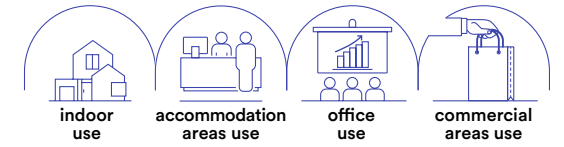

	colour temp.	colour
DAVINCI-W-S40C 8031414894017		
lumen	1855 lm	
DAVINCI-W-S40M 8031414894024		
lumen	1855 lm	
DAVINCI-S40C 8031414893997		
lumen	1855 lm	
DAVINCI-S40M 8031414894000		
lumen	1855 lm	

	colour temp.	colour
DAVINCI-W-S15C 8031414893973		
lumen	780 lm	
DAVINCI-W-S15M 8031414893980		
lumen	780 lm	
DAVINCI-S15C 8031414893959		
lumen	780 lm	
DAVINCI-S15M 8031414893966		
lumen	780 lm	

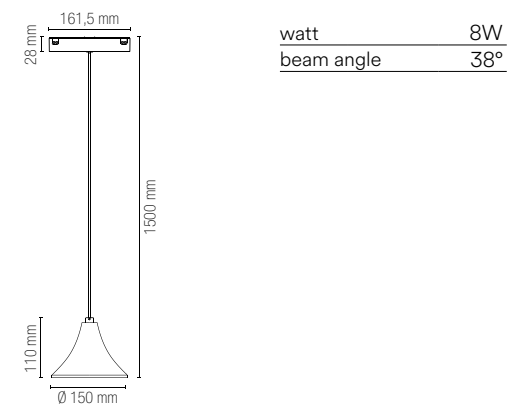
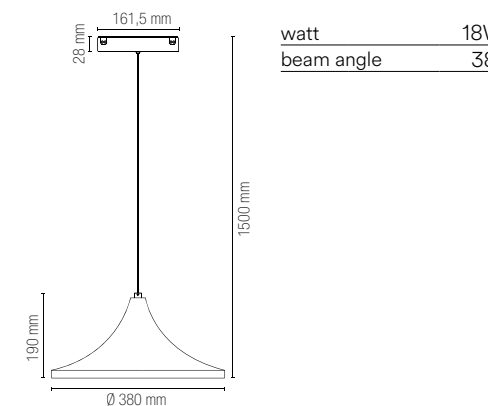

Fotometria del prodotto / Photometric curve

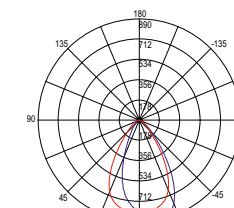

DAVINCI-S40

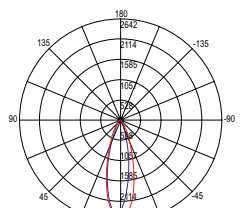

DAVINCI-S15



SISTEMA BINARI / TRACK LIGHTS
In.tec light

DA VINCI PROJECT 48V

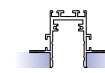

Da Vinci Project 48V / RECESSED TRACK TRIMLESS Sistema di montaggio a incasso a filo / Recess mount system trimless

Binari ed accessori / Track rail and components



DAVINCI-TL-2M 8031414878055

Binario sistema Davinci
montaggio ad incasso a filo
2 m nero 48V.
Tappi e staffa di fissaggio inclusi.

Davinci system track rail invisible
recessed trimless mount black
colour 2 m 48V.
Cups and fixing bracket included.

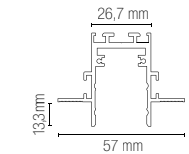

DAVINCI-TL-L 8031414878109

Connettore angolare in alluminio
per binario elettrificato incasso a filo
(trimless) sistema sfere volventi.

Angular connection in aluminum
for Davinci trimless recessed rail
in rolling spheres joint system.

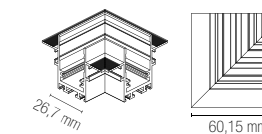

DAVINCI-TL-LVI 8031414878673

Connettore angolare verticale
connessione interna per binario
elettrificato incasso a filo (trimless)
con sistema sfere volventi.

Vertical angular connector internal
connection for track electrified
recessed rail (trimless) system
built in rolling spheres joint system.

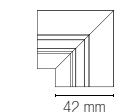

DAVINCI-TL-LVE 8031414878147

Connettore angolare verticale con
connessione esterna in alluminio
per binario elettrificato incasso a filo
(trimless) con sistema sfere volventi.

Angular external emission
connection in aluminum for
electrified track trimless recessed
rail in rolling spheres joint system.

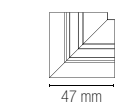

DAVINCI-TL-CAP 8031414878093

Tappo laterale per binario da
incasso a filo (trimless)
sistema sfere volventi.



End cap for Davinci trimless
recessed rail in rolling
spheres joint system.



Da Vinci Project 48V / RECESSED TRACK

Sistema di montaggio a incasso con cornice / Recess mount system with external trim

Binari ed accessori / Track rail and components



DAVINCI-INC-2M-BCO
8031414894130

Binario sistema Davinci montaggio ad incasso 2 m bianco 48V. Tappi e staffa di fissaggio inclusi.

Davinci system track rail recessed mount white colour 2 m 48V. Cups and fixing bracket included.



DAVINCI-INC-2M
8031414878024

Binario sistema Davinci montaggio ad incasso 2 m nero 48V. Tappi e staffa di fissaggio inclusi.

Davinci system track rail recessed mount black colour 2 m 48V. Cups and fixing bracket included.

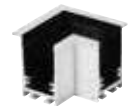
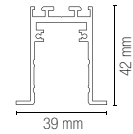

DAVINCI-INC-L-BCO
8031414894147

Connettore angolare per binario elettrificato incasso sistema sfere volventi.

Angular connector for electrified track built in rolling spheres joint system.

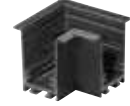

DAVINCI-INC-L
8031414878116

Connettore angolare per binario elettrificato incasso sistema sfere volventi.

Angular connector for electrified track built in rolling spheres joint system.

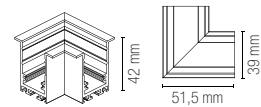

DAVINCI-INC-LVI-BCO
8031414894154

Connettore angolare verticale connessione interna per binario elettrificato incasso sistema sfere volventi.

Vertical angular connector internal connection for track electrified system built in rolling spheres joint system.



DAVINCI-INC-LVI
8031414878123

Connettore angolare verticale connessione interna per binario elettrificato incasso sistema sfere volventi.

Vertical angular connector internal connection for track electrified system built in rolling spheres joint system.

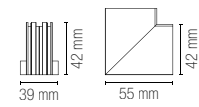

DAVINCI-INC-LVE-BCO
8031414894161

Connettore angolare verticale connessione esterna per binario elettrificato incasso sistema sfere volventi.

Vertical angular connector external connection for track electrified system built in rolling spheres joint system.



DAVINCI-INC-LVE
8031414878130

Connettore angolare verticale connessione esterna per binario elettrificato incasso sistema sfere volventi.

Vertical angular connector external connection for track electrified system built in rolling spheres joint system.

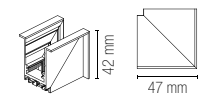

DAVINCI-INC-CAP-BCO
8031414894178

Tappo laterale per binario ad incasso sistema sfere volventi.

End cap for recessed Davinci with rolling spheres joint system.



DAVINCI-INC-CAP
8031414878413

Tappo laterale per binario ad incasso sistema sfere volventi.

End cap for recessed Davinci with rolling spheres joint system.

Da Vinci Project 48V / PENDANT

Sistema di montaggio a sospensione biemissione/ Biemission suspension mounting system

Binari ed accessori / Track rail and components



DAVINCI-H-2M
8031414878017

Binario sistema Davinci per montaggio a sospensione con doppia emissione; nero da 2 m 48V. Tappi e staffa di fissaggio inclusi.

Davinci system rail for suspension mounting with double emission; black 2 m 48V. Cups and fixing bracket included.

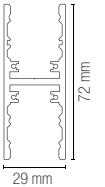

DAVINCI-H-L
8031414878048

Connettore angolare in alluminio per binario elettrificato biemissione con sistema sfere volventi.

Aluminum angular connection for double emission electrified track with rolling ball system.

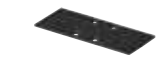
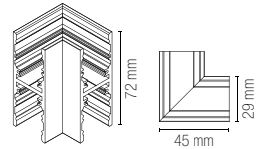

DAVINCI-H-CAP
8031414878451

Tappo laterale per binario biemissione con sistema sfere volventi.

End cap for double emitting Davinci rail in rolling spheres joint system.



DAVINCI-BOX
8031414878598

Scatola per alloggiamento driver e collegamento elettrico binari Davinci a sospensione.

Canopy for driver and connection box for suspension Davinci rail.

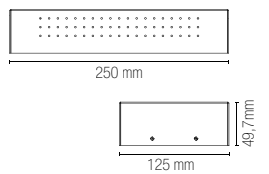

DAVINCI-S-3
8031414879762

Sistema sospensione 2 cavi di acciaio da 3m per binari Davinci.

Suspension kit 2 x 3m steel wire.

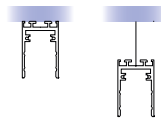

Da Vinci Project 48V / SURFACE MOUNTED

Sistema di montaggio a plafoniera o a sospensione a vista/ Ceiling or suspension mounting system

Binari ed accessori / Track rail and components

Driver 48V per sistema Davinci p. 838
48V drivers for Davinci system p. 838



DAVINCI-ST-2M-BCO
8031414894185

Binario sistema Davinci con montaggio a soffitto o sospensione da 2 m bianco 48V. Tappi e staffa di fissaggio inclusi.

Davinci system rail with ceiling mounting or suspension 2 m white 48V. Cups and fixing bracket included.



DAVINCI-ST-2M
8031414878031

Binario sistema Davinci con montaggio a soffitto o sospensione da 2 m nero 48V. Tappi e staffa di fissaggio inclusi.

Davinci system rail with ceiling mounting or suspension 2 m black 48V. Cups and fixing bracket included.

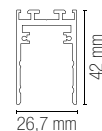

DAVINCI-ST-L-BCO
8031414894192

Connettore angolare per binario elettrificato montaggio a soffitto o sospensione sistema sfere volventi.

Angular connection for ceiling mounting electrified track or suspension in rolling spheres joint system.



DAVINCI-ST-L
8031414878062

Connettore angolare per binario elettrificato montaggio a soffitto o sospensione sistema sfere volventi.

Angular connection for ceiling mounting electrified track or suspension in rolling spheres joint system.

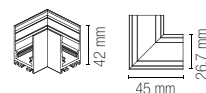
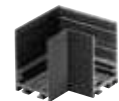

DAVINCI-ST-LVI-BCO
8031414894208

Connettore angolare per binario elettrificato connessione interna con sistema sfere volventi.

Angular connector for track electrified internal connection with spheres rolling joint system.



DAVINCI-ST-LVI
8031414878079

Connettore angolare per binario elettrificato connessione interna con sistema sfere volventi.

Angular connector for track electrified internal connection with spheres rolling joint system.

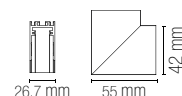

DAVINCI-ST-LVE-BCO
8031414894215

Connettore angolare per binario elettrificato connessione esterna e sistema a sfere volventi.

Angular connector for external connection electrified track in rolling spheres joint system.



DAVINCI-ST-LVE
8031414878086

Connettore angolare per binario elettrificato connessione esterna e sistema a sfere volventi.

Angular connector for external connection electrified track in rolling spheres joint system.

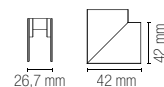

DAVINCI-ST-CAP-BCO
8031414894222

Tappo laterale per binario biemissione con sistema sfere volventi.

End cap for double emitting Davinci rail in rolling spheres joint system.



DAVINCI-ST-CAP
8031414878468

Tappo laterale per binario biemissione con sistema sfere volventi.

End cap for double emitting Davinci rail in rolling spheres joint system.



DAVINCI-BOX-BCO
8031414894246

Scatola per alloggiamento driver e collegamento elettrico binari Davinci a sospensione.

Canopy for driver and connection box for suspension Davinci rail.



DAVINCI-BOX
8031414878598

Scatola per alloggiamento driver e collegamento elettrico binari Davinci a sospensione.

Canopy for driver and connection box for suspension Davinci rail.

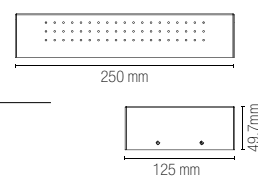

DAVINCI-S-3-BCO
8031414894239

Sistema sospensione 2 cavi di acciaio da 3m per binari Davinci.

Suspension kit 2 x 3m steel wire.



DAVINCI-S-3
8031414879762

Sistema sospensione 2 cavi di acciaio da 3m per binari Davinci.

Suspension kit 2 x 3m steel wire.



DAVINCI-NEST
8031414878161

Innesto per elettrificazione 48V compatibile con tutti i modelli di binario del sistema Davinci.

48V power engine for all Davinci rail system models.



DAVINCI-I-CONN
8031414878178

Connettore 48V compatibile con i modelli di binario sistema Davinci.

Connector 48V compatible with all the Davinci rail system models.



DAVINCI-L-CONN
8031414878185

Connettore angolare 48V compatibile con tutti i modelli di binario del sistema Davinci.

Angular connector 48V compatible with all the Davinci rail system models.

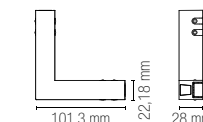

DAVINCI-LVI-CONN
8031414878192

Connettore angolare interno 48V compatibile con tutti i modelli di binario del sistema Davinci.

Internal angular connector 48V compatible with all the Davinci rail system models.

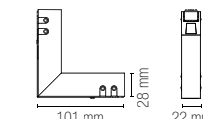

DAVINCI-LVE-CONN
8031414878208

Connettore angolare esterno 48V compatibile con tutti i modelli di binario del sistema Davinci.

External angular connector 48V compatible with all the Davinci rail system models.

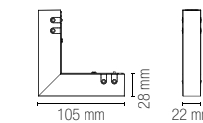

DAVINCI-FLEX
8031414894253

Innesto per elettrificazione 48V flessibile compatibile con tutti i modelli di binario Davinci.

Flexible 48V electrification mount compatible with all Davinci rail models.



DAVINCI-COVER-2M
8031414878154

Cover nera compatibile con tutti i modelli di binario Davinci 200 cm.

Cover in black colour compatible with all the Davinci track rail models 200 cm.



DAVINCI-BRAKE
8031414878383

Kit 2pz fermi per corpi illuminanti sistema con sfere volventi.

Kit 2pcs of side brake for Davinci light source modules with rolling spheres joint system.



**BERNINI
PROJECT
48V**



BERNINI LINE

Lampada lineare orientabile a LED in termoplastica e alluminio con finitura in nero opaco.

Linear adjustable LED lamp in thermoplastic and aluminum with matt black finish.

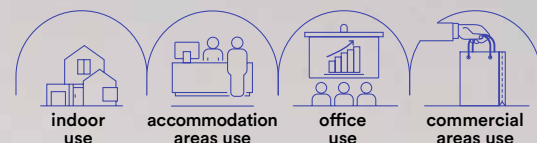

Materiale
alluminio e termoplastica

Colore
nero opaco

Temperatura colore
3000K / 4000K



Driver

DC48V non incluso

Material
aluminum and thermoplastic

Colour
matt black

Colour temperature
3000K / 4000K



Driver

DC48V not included

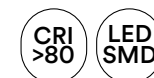

technical information **BERNINI LINE**



UGR <19



BERNINI-LINE12C-UGR 8031414897995	colour temp.	colour
lumen	720 lm	
BERNINI-LINE12M-UGR 8031414898008	colour temp.	colour
lumen	720 lm	
watt	6W	
beam angle	30°	



colour temp.



Fotometria del prodotto / Photometric curve

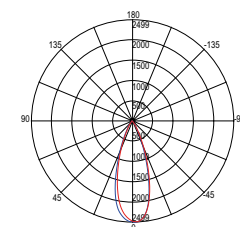

BERNINI-LINE12C-UGR

Accessorio non incluso / Not included accessory



BERNINI-LINE-ADAT12

8031414898169
Adattatore per lampada lineare LED / Adapter for linear LED lamp



BERNINI-LINE12C 8031414897957	colour temp.	colour
lumen	720 lm	
BERNINI-LINE12M 8031414897964	colour temp.	colour
lumen	720 lm	
watt	6W	
beam angle	30°	



colour temp.

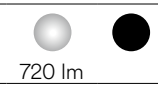

Fotometria del prodotto / Photometric curve

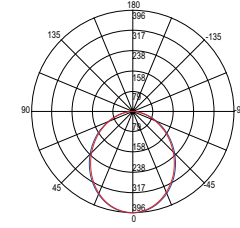

BERNINI-LINE12C

Accessorio non incluso / Not included accessory



BERNINI-LINE-ADAT12

8031414898169
Adattatore per lampada lineare LED / Adapter for linear LED lamp



BERNINI-LINE22C-UGR 8031414898015	colour temp.	colour
lumen	1440 lm	
BERNINI-LINE22M-UGR 8031414898022	colour temp.	colour
lumen	1440 lm	
watt	12W	
beam angle	30°	

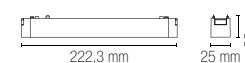

colour temp.

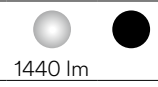

Fotometria del prodotto / Photometric curve

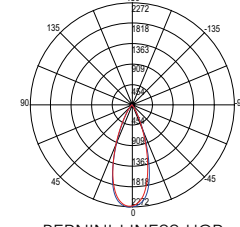

BERNINI-LINE22C-UGR

Accessorio non incluso / Not included accessory



BERNINI-LINE-ADAT22

8031414898176
Adattatore per lampada lineare LED / Adapter for linear LED lamp

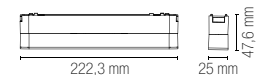

BERNINI-LINE22C 8031414897971	colour temp.	colour
lumen	1500 lm	
BERNINI-LINE22M 8031414897988	colour temp.	colour
lumen	1500 lm	
watt	12W	
beam angle	30°	

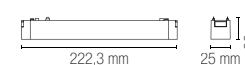

colour temp.

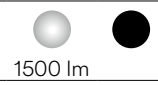

Fotometria del prodotto / Photometric curve

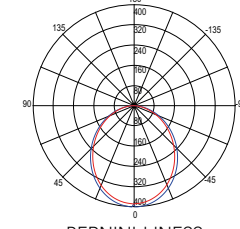

BERNINI-LINE22C

Accessorio non incluso / Not included accessory



BERNINI-LINE-ADAT22

8031414898176
Adattatore per lampada lineare LED / Adapter for linear LED lamp

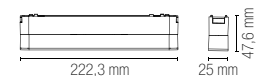

BERNINI FANS

Faro luce spot orientabile per sistema a binario in termoplastica con finitura in nero opaco.
Adjustable spot light in thermoplastic and aluminum track system with matt black finish.

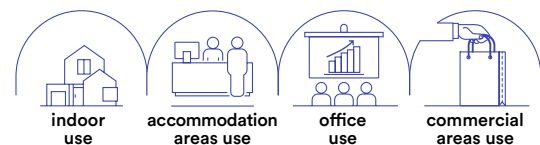

BERNINI TUBO

Lampada sospensione LED per sistema binario in termoplastica e alluminio con finitura in nero opaco.
LED suspension lamp in aluminum and thermoplastic rail system with matt black finish.



Materiale
alluminio e termoplastica

Colore
nero opaco



Temperatura colore
3000K / 4000K



Driver

DC48V non incluso

Material
aluminum and thermoplastic

Colour
matt black



Colour temperature
3000K / 4000K



Driver

DC48V not included



	colour temp.	colour
BERNINI-FANS-5C 8031414898039 lumen		
	550 lm	
BERNINI-FANS-5M 8031414898046 lumen		
	550 lm	
watt	5W	
beam angle	24°	

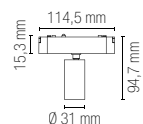

	colour temp.	colour
BERNINI-FANS-15C 8031414898053 lumen		
	1750 lm	
BERNINI-FANS-15M 8031414898060 lumen		
	1750 lm	
watt	15W	
beam angle	30°	

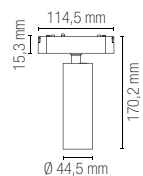

Fotometria del prodotto /
Photometric curve

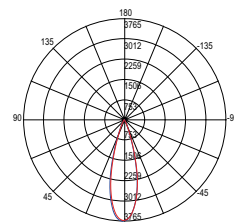

BERNINI-FANS-5

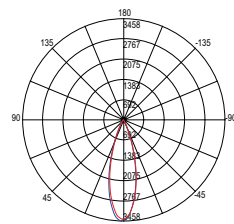

BERNINI-FANS-15

Materiale
alluminio e termoplastica

Colore
nero opaco



Temperatura colore
3000K / 4000K



Driver

DC48V non incluso

Material
aluminum and thermoplastic

Colour
matt black



Colour temperature
3000K / 4000K



Driver

DC48V not included

	colour temp.	colour
BERNINI-S10C 8031414898077 lumen		
	1100 lm	
BERNINI-S10M 8031414898084 lumen		
	1100 lm	
watt	9W	
beam angle	24°	

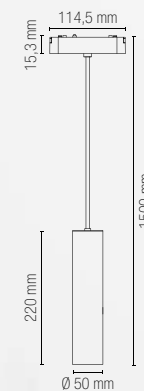

Fotometria del prodotto /
Photometric curve

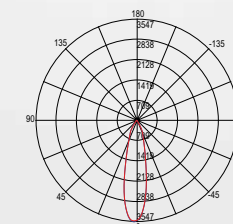











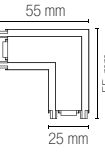

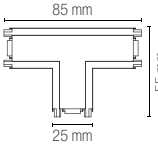

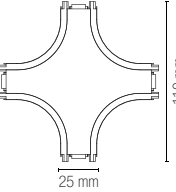

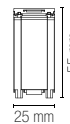

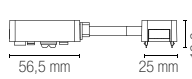

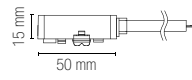
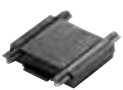

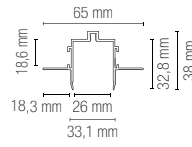

BERNINI-S10

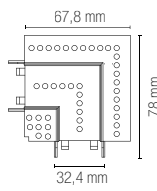

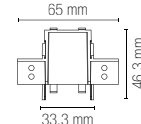
Binari ed accessori.
Track rail and components.

Driver 48V per sistema Bernini p. 838
48V drivers for Bernini system p. 838

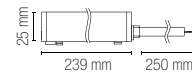
	BERNINI-2M 8031414897735 Binario Bernini 2 metri nero 48V. 2 Tappi inclusi.	Bernini track rail black color 2 meters 48V. 2 Cups included.	
	BERNINI-L 8031414897773 Connettore angolare per binario elettrificato 48V.	Corner connector for 48V track.	
	BERNINI-T 8031414897780 Connettore a T per binario elettrificato 48V.	T connector for 48V electrified track.	
	BERNINI-X 8031414898091 Connettore a croce per binario elettrificato 48V.	Cross connector for 48V electrified track.	
	BERNINI-LVI 8031414898107 Connettore angolare per binario elettrificato 48V.	Angular connector for 48V electrified track.	
	BERNINI-NEST 8031414898145 Innesto per elettrificazione 48V compatibile con tutti i modelli di binario Bernini.	48V electrification mount compatible with all Bernini rail models.	
	BERNINI-NEST 8031414898145 Innesto per elettrificazione 48V compatibile con tutti i modelli di binario Bernini.	48V electrification mount compatible with all Bernini rail models.	
	BERNINI-I-CONN 8031414898114 Connettore 48V compatibile con tutti i modelli di binario Bernini.	48V connector compatible with all Bernini rail models.	

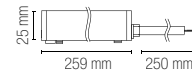
	BERNINI-TL-2M 8031414897759 Alloggio per sistema binario montaggio ad incasso a filo 2 metri.	Housing for recessed trimeless track rail system 2 meters.	
	BERNINI-TL-L 8031414898138 Connettore angolare verticale per alloggiamento con montaggio ad incasso a filo per binario Bernini.	Angular vertical connector for housing with recessed trimeless track rail system.	
	BERNINI-TL-LVI 8031414898121 Connettore angolare verticale per alloggiamento con montaggio ad incasso a filo per binario Bernini.	Angular vertical connector for housing with recessed trimeless track rail system.	
	BERNINI-CAP 8031414897742 Tappo laterale per binario elettrificato 48V.	Side cup for 48V electrified track.	
	BERNINI-COVER-2M 8031414897766 Cover nera compatibile con i modelli del binario Bernini.	Black cover compatible with Bernini track rail models.	
	BERNINI-DR100 8031414898183 Driver 48V 100W corrente costante.	Driver 48V 100W constant current.	
	BERNINI-DR200 8031414897940 Driver 48V 200W corrente costante.	Driver 48V 200W constant current.	

THREE-PHASE TRACK



THREE-PHASE TRACK

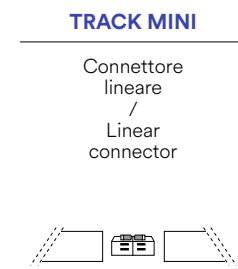
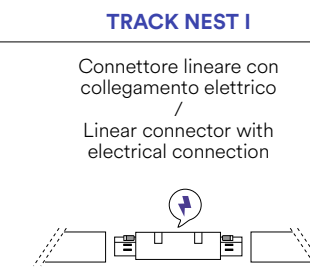
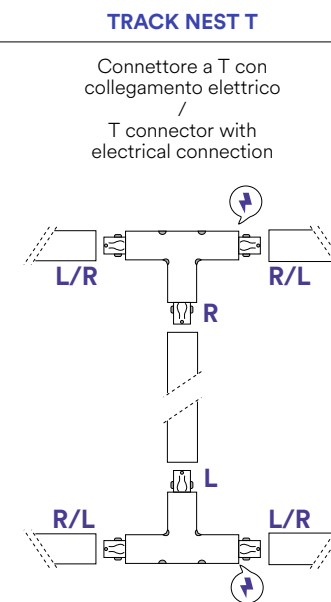
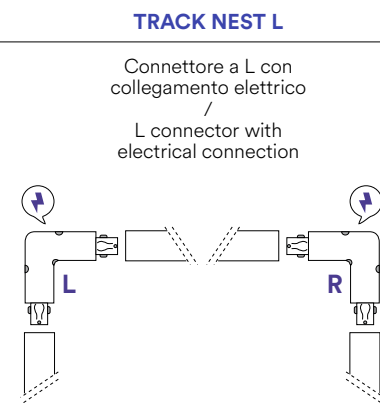
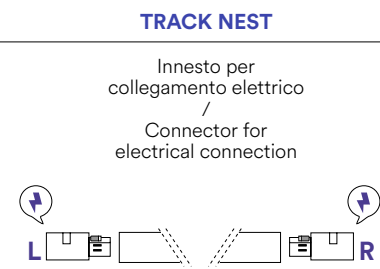
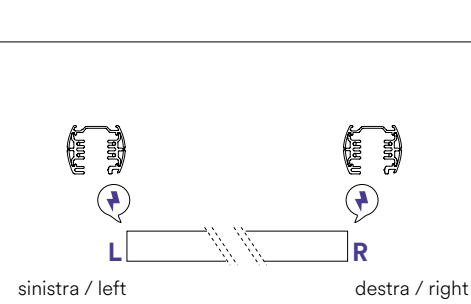
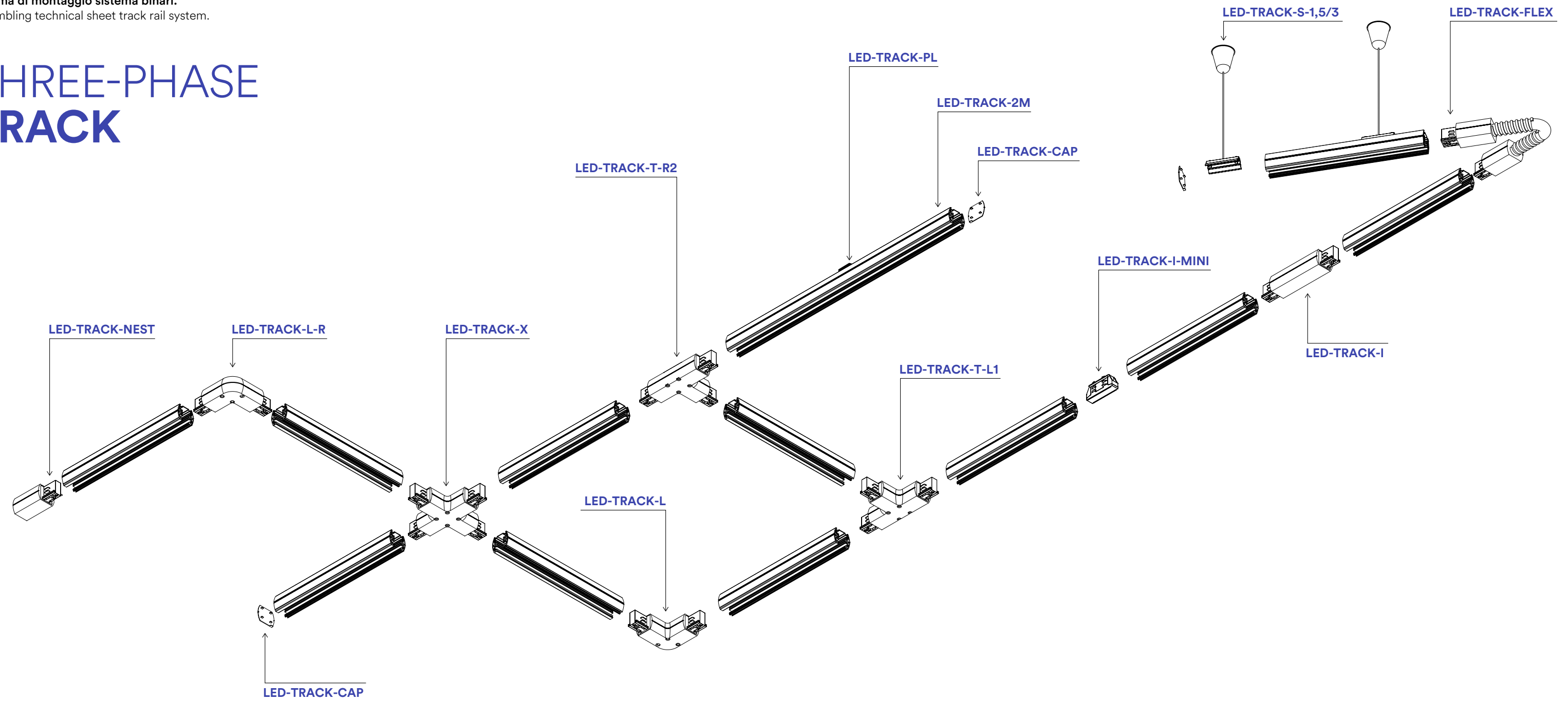

Trifase / Three-phase

JET

Proiettore a binario in alluminio con adattatore trifase.
Aluminum track spotlight with three-phase adapter.

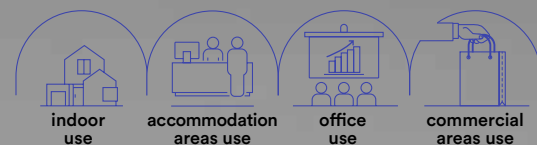

100°
330°

Materiale
alluminio

Material
aluminum

Colore
bianco opaco
nero opaco

Colour
matt white
matt black



Temperatura colore selezionabile
3000K / 4000K / 6500K

Selectable color temperature
3000K / 4000K / 6500K



Driver
incluso

Driver
included



technical information **JET**



LED-JET-W-20
8031414893805
lumen 2100 lm

LED-JET-B-20
8031414893775
lumen 2100 lm

watt 20W
beam angle 38°
pf 0.90

colour temp.	colour

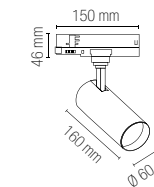

LED-JET-W-30
8031414893812
lumen 3235 lm

LED-JET-B-30
8031414893782
lumen 3235 lm

watt 30W
beam angle 38°
pf 0.90

colour temp.	colour

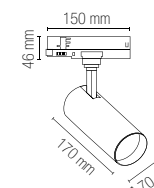

LED-JET-W-40
8031414893829
lumen 4300 lm

LED-JET-B-40
8031414893799
lumen 4300 lm

watt 40W
beam angle 38°
pf 0.90

colour temp.	colour

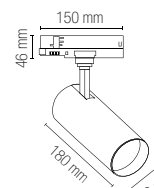

Fotometria del prodotto / Photometric curve

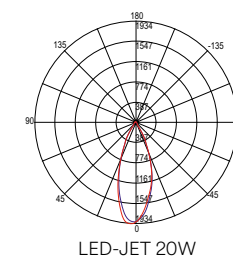

LED-JET 20W

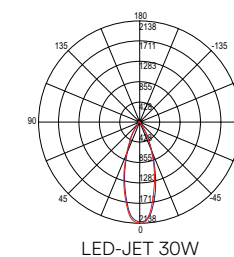

LED-JET 30W

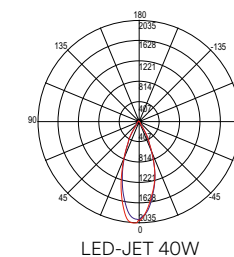

LED-JET 40W

Trifase / Three-phase

EXPLORER

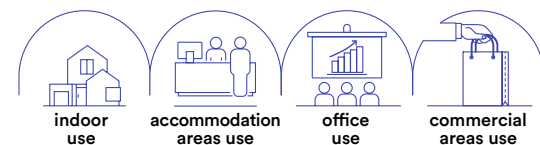

Materiale
alluminio

Colore

bianco opaco
nero opaco



Temperatura colore
3000K / 4000K



Driver
incluso

Material
aluminum

Colour
matt white
matt black



Colour temperature
3000K / 4000K



Driver
included

Faro a binario in alluminio con adattatore trifase e angolo di luce regolabile.
Aluminum track light with three-phase adapter and adjustable light angle.

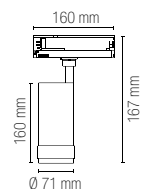

Angolo di luce regolabile /
Adjustable beam angle



	colour temp.	colour
LED-EXPLORER-W-30C 8031414894284 lumen	3000K	white
LED-EXPLORER-W-30M 8031414894291 lumen	4000K	white
LED-EXPLORER-B-30C 8031414894260 lumen	3000K	black
LED-EXPLORER-B-30M 8031414894277 lumen	4000K	black
watt	30W	
beam angle	10° - 60°	
pf	0.90	

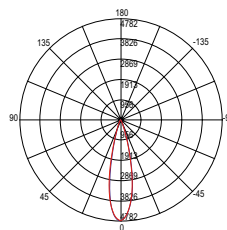

LED-EXPLORER



SISTEMA BINARI / TRACK LIGHTS

In.tec light

Trifase / Three-phase

KONE

Proiettore a binario in alluminio pressofuso con adattatore trifase invisibile.

Die-cast aluminum track projector with invisible three-phase adapter.

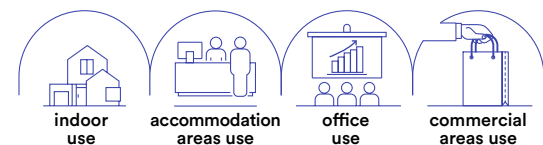

collection **KONE**

Materiale

corpo in alluminio pressofuso

Colore

bianco opaco
nero opaco
rosa opaco
verde opaco
giallo opaco



Temperatura colore

3000K / 4000K



Driver

incluso

Material

aluminum die cast body

Colour

matt white
matt black
matt pink
matt green
matt yellow



Colour temperature

3000K / 4000K



Driver

included



In.tec light **SISTEMA BINARI / TRACK LIGHTS**

KONE



Accessori non inclusi / Not included accessories



Retina antiabbagliamento / Anti-glare retina

LED-KONE-MESH62 8031414870455	per/for	13W
LED-KONE-MESH80 8031414870462	per/for	24W
LED-KONE-MESH100 8031414870431	per/for	42W



Deviatore flusso luminoso / Luminous flux diverter

LED-KONE-DIFF62 8031414870448	per/for	13W
LED-KONE-DIFF80 8031414870417	per/for	24W
LED-KONE-DIFF100 8031414870424	per/for	42W

	colour temp.	colour
LED-KONE-ROS-24M 8031414866663	2365 lm	
LED-KONE-VER-24M 8031414866687	2365 lm	
LED-KONE-GIA-24M 8031414866700	2365 lm	
watt	24W	
beam angle	38°	
pf	-	

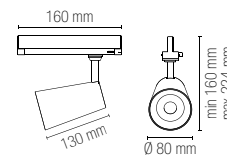

	colour temp.	colour
LED-KONE-W-13C 8031414867691	1175 lm	
LED-KONE-W-13M 8031414867677	1175 lm	
LED-KONE-B-13C 8031414867684	1175 lm	
LED-KONE-B-13M 8031414867622	1175 lm	
watt	13W	
beam angle	38°	
pf	-	

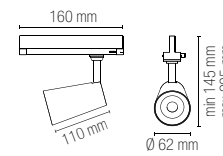

	colour temp.	colour
LED-KONE-W-24C 8031414867745	2365 lm	
LED-KONE-W-24M 8031414867714	2365 lm	
LED-KONE-B-24C 8031414867721	2365 lm	
LED-KONE-B-24M 8031414867707	2365 lm	
watt	24W	
beam angle	38°	
pf	-	

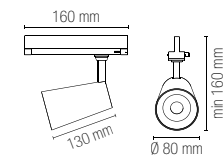

	colour temp.	colour
LED-KONE-W-30C 8031414883257	3860 lm	
LED-KONE-W-30M 8031414883264	3860 lm	
LED-KONE-B-30C 8031414866670	3860 lm	
LED-KONE-B-30M 8031414883240	3860 lm	
watt	30W	
beam angle	38°	
pf	0.90	

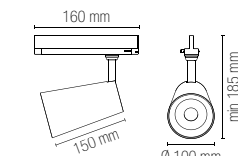

	colour temp.	colour
LED-KONE-W-42C 8031414867783	4230 lm	
LED-KONE-W-42M 8031414867752	4230 lm	
LED-KONE-B-42C 8031414867769	4230 lm	
LED-KONE-B-42M 8031414867738	4230 lm	
watt	42W	
beam angle	38°	
pf	0.90	

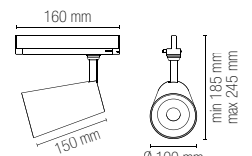

Fotometria del prodotto / Photometric curve

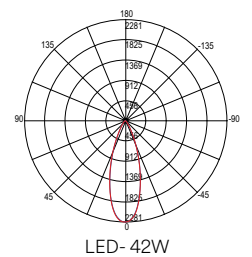
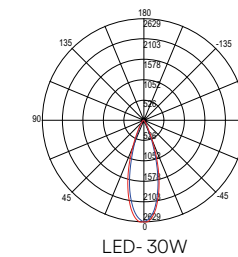
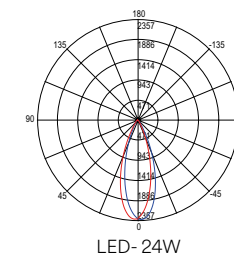
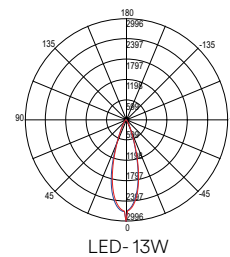
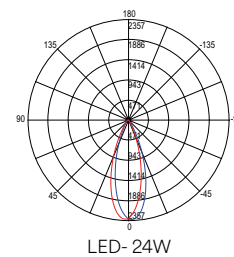

Trifase / Three-phase

KONE FOOD

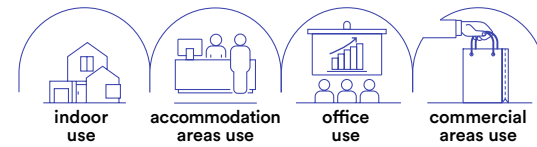

- Materiale**
corpo in alluminio pressofuso
- Colore**
bianco opaco
nero opaco
- Temperatura colore**
2500K / 3000K / 3100K
- Driver**
integrato
- Material**
aluminum die cast body
- Colour**
matt white
matt black
- Colour temperature**
2500K / 3000K / 3100K
- Driver**
built-in

Proiettore a binario in alluminio pressofuso con adattatore trifase per l'illuminazione di generi alimentari.
Die-cast aluminum track projector with three-phase adapter for food lighting.

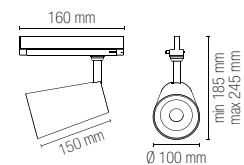

illuminazione per generi alimentari / Food lighting

	colour temp.	K	CRI	colour
 LED-KONE-W-30BR 8031414883370	2500K	2500 K	>90	White
LED-KONE-B-30BR 8031414883356	2500K	2500 K	>90	Black
 LED-KONE-W-30RM 8031414883400	3100K	3100 K	>70	White
LED-KONE-B-30RM 8031414883332	3100K	3100 K	>70	Black
 LED-KONE-W-30FM 8031414883387	3000K	3000 K	>63	White
LED-KONE-B-30FM 8031414883349	3000K	3000 K	>63	Black
 LED-KONE-W-30FR 8031414883394	3000K	3000 K	>93	White
 LED-KONE-B-30FR 8031414883363	3000K	3000 K	>93	Black
watt				30W
beam angle				38°
pf				0.90



SISTEMA BINARI / TRACK LIGHTS

In.tec light



Trifase / Three-phase

ACTION

Proiettore a binario in alluminio pressofuso con adattatore trifase invisibile.
Die-cast aluminum track projector with invisible three-phase adapter.

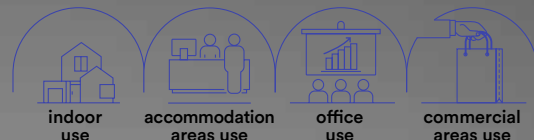

Materiale
corpo in alluminio pressofuso

Material
aluminum die cast body

Colore
bianco opaco
nero opaco

Colour
matt white
matt black



Temperatura colore
3000K / 4000K

Colour temperature
3000K / 4000K



Driver
incluso

Driver
included



technical information **ACTION**



	colour temp.	colour	watt	beam angle	pf
LED-ACTION-W-13C 8031414867820 lumen	3000K	white	13W	38°	-
LED-ACTION-W-13M 8031414867790 lumen	4000K	white	13W	38°	-
LED-ACTION-B-13C 8031414867806 lumen	3000K	black	13W	38°	-
LED-ACTION-B-13M 8031414867776 lumen	4000K	black	13W	38°	-

	colour temp.	colour	watt	beam angle	pf
LED-ACTION-W-20C 8031414867837 lumen	3000K	white	20W	38°	-
LED-ACTION-W-20M 8031414866724 lumen	4000K	white	20W	38°	-
LED-ACTION-B-20C 8031414867844 lumen	3000K	black	20W	38°	-
LED-ACTION-B-20M 8031414867813 lumen	4000K	black	20W	38°	-

	colour temp.	colour	watt	beam angle	pf
LED-ACTION-W-42C 8031414867875 lumen	3000K	white	42W	38°	0.90
LED-ACTION-W-42M 8031414867882 lumen	4000K	white	42W	38°	0.90
LED-ACTION-B-42C 8031414867851 lumen	3000K	black	42W	38°	0.90
LED-ACTION-B-42M 8031414867868 lumen	4000K	black	42W	38°	0.90

Accessori non inclusi / Not included accessories

Retina antiabbagliamento / Anti-glare retina		per 13W	Deviatore flusso luminoso / Luminous flux diverter		per 13W
LED-ACTION-MESH50 8031414875986	per 13W	LED-ACTION-DIFF50 8031414875955	per 13W		
LED-ACTION-MESH62 8031414875993	per 20W	LED-ACTION-DIFF62 8031414875962	per 20W		
LED-ACTION-MESH90 8031414876006	per 42W	LED-ACTION-DIFF90 8031414875979	per 42W		

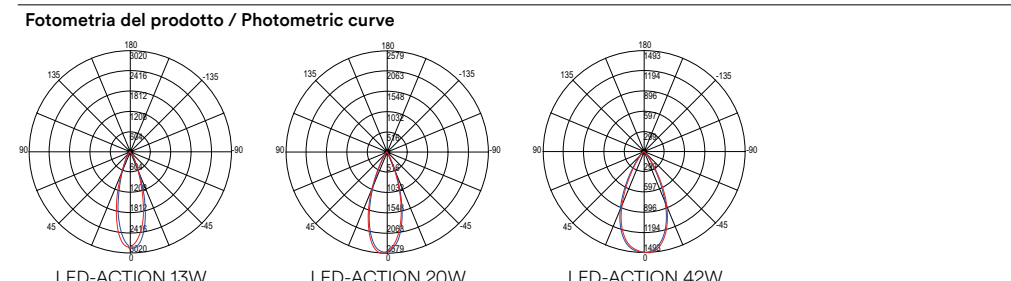

SISTEMA BINARI / TRACK LIGHTS

In.tec light

Trifase / Three-phase

ROCKET

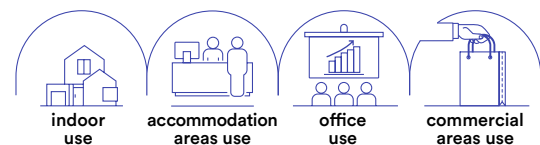

Materiale
corpo in alluminio pressofuso

Colore
bianco opaco
nero opaco
cromo
oro
bronzo



Temperatura colore
3000K / 4000K



Driver
integrato

Material
aluminum
die cust body

Colour
matt white
matt black
chrome
gold
bronze

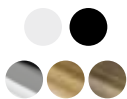

Colour temperature
3000K / 4000K



Driver
built-in

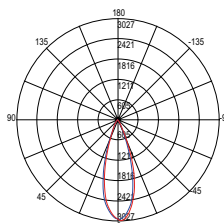

LED-ROCKET-7



Proiettore a binario con luce spot in alluminio pressofuso con adattatore trifase.
Track headlamp with spot light in die-cast aluminum with three-phase adapter.

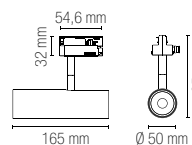

	colour temp.	colour
LED-ROCKET-7C BCO 8031414861972	3000K	3000K
LED-ROCKET-7M BCO 8031414864171	4000K	4000K
lumen	500 lm	
LED-ROCKET-7C NERO 8031414861965	3000K	3000K
LED-ROCKET-7M NERO 8031414864300	4000K	4000K
lumen	500 lm	
LED-ROCKET-7C CR 8031414864294	3000K	3000K
LED-ROCKET-7M CR 8031414864317	4000K	4000K
lumen	500 lm	
LED-ROCKET-7C ORO 8031414864164	3000K	3000K
LED-ROCKET-7M ORO 8031414864737	4000K	4000K
lumen	500 lm	
LED-ROCKET-7C BRO 8031414864188	3000K	3000K
LED-ROCKET-7M BRO 8031414864744	4000K	4000K
lumen	500 lm	
watt	7W	
beam angle	38°	

Trifase / Three-phase

ROCKET

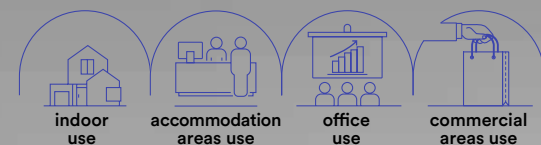

Spot applique.
Wall spot light.

Materiale
corpo in alluminio pressofuso

Colore
bianco opaco
nero opaco



Temperatura colore
3000K / 4000K



Driver
integrato

Material
aluminum
die cust body

Colour
matt white
matt black



Colour temperature
3000K / 4000K



Driver
built-in

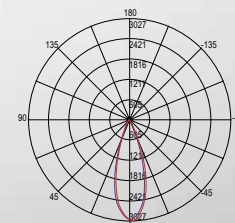
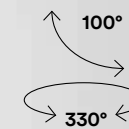

LED-ROCKET-APC



	colour temp.	colour
LED-ROCKET-APC BCO 8031414861996	3000K	3000K
LED-ROCKET-APM BCO 8031414864966	4000K	4000K
lumen	500 lm	
LED-ROCKET-APC NERO 8031414861989	3000K	3000K
LED-ROCKET-APM NERO 8031414864980	4000K	4000K
lumen	500 lm	
watt	7W	
beam angle	38°	

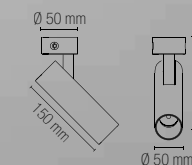

SISTEMA BINARI / TRACK LIGHTS

In.tec light

Trifase / Three-phase

SQUIB

Proiettore a binario in alluminio con adattatore trifase.
Aluminum track headlamp with three-phase adapter.

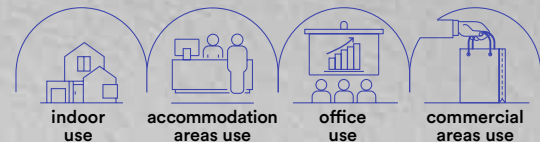

Materiale
alluminio

Colore
bianco satinato
nero satinato
oro satinato



Material
aluminum

Colour
satin white
satin black
satin gold

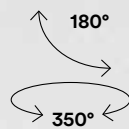

I-SQUIB-BCO
8031414883226
I-SQUIB-NER
8031414883233
I-SQUIB-ORO
8031414895397

colour



Lampadina non inclusa /
Light bulb not included

1 x GU10 MAX 25W

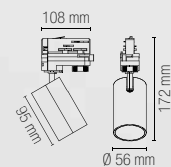

Trifase / Three-phase

EXPRESS

Proiettore a binario in alluminio con adattatore trifase.
Aluminum track headlamp with three-phase adapter.

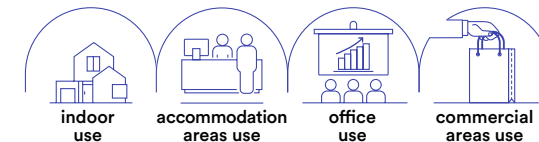

Materiale
metallo

Colore
bianco satinato
nero satinato



Material
metal

Colour
satin white
satin black



LED-EXPRESS
8031440360470
LED-EXPRESS-B
8031414864676

colour

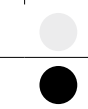

Lampadina non inclusa /
Light bulb not included

1 x E27 MAX 42W

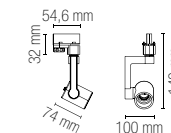

SISTEMA BINARI / TRACK LIGHTS

In.tec light

Trifase / Three-phase

OBOE

Materiale

corpo in alluminio pressofuso

Colore

bianco
nero
cromo
oro
bronzo



Temperatura colore
3000K / 4000K



Driver

integrato

Material

aluminum
die cast body

Colour

white
black
chrome
gold
bronze



Colour temperature
3000K / 4000K



Driver

built-in

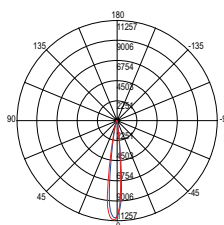

LED-OBOE-SC

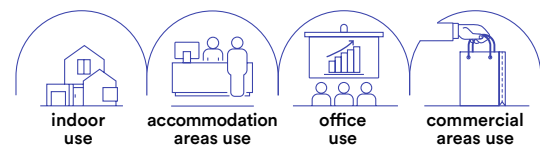

Trifase / Three-phase

CLOCK

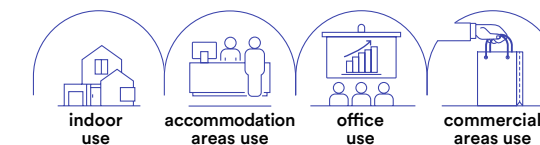

Materiale
alluminio con cavo in tessuto nero

Colore

cromo
nero anodizzato



Material

aluminum with black fabric cable

Colour

chrome
black anodized



Sospensione in alluminio con adattatore trifase e cavo in tessuto nero.

Pendant lamp in aluminum with three-phase adaptor and black fabric cable.



I-TRACK-CLOCK-CR

8031414864072

I-TRACK-CLOCK-NERO

8031414864096

1 x E27 MAX 60W



Sospensione in alluminio pressofuso con adattatore trifase.

Die-cast aluminum suspension with three-phase adapter.

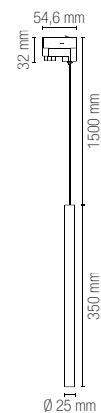

LED-OBOE-SC BCO

8031414865109

LED-OBOE-SM BCO

8031414862047

lumen

colour temp. colour



240 lm

LED-OBOE-SC NERO

8031414865147

LED-OBOE-SM NERO

8031414862030

lumen

colour temp. colour



240 lm

LED-OBOE-SC CR

8031414865130

LED-OBOE-SM CR

8031414862061

lumen

colour temp. colour



240 lm

LED-OBOE-SC ORO

8031414865123

LED-OBOE-SM ORO

8031414862054

lumen

colour temp. colour



240 lm

LED-OBOE-SC BRO

8031414865116

LED-OBOE-SM BRO

8031414864287

lumen

colour temp. colour



240 lm

watt

3,5W

beam angle

40°



Lampadina non inclusa / Light bulb not included



Portalampada incluso / Lampholder included

Trifase / Three-phase

MAXWELL

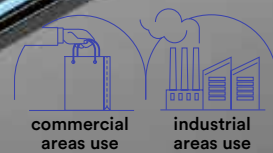

Materiale
alluminio

Material
aluminum

Colore
bianco
nero

Colour
white
black



Temperatura colore
3000K / 4000K

Colour temperature
3000K / 4000K



Driver
integrato

Driver
built-in

Durata e on/off
50.000h
>25.000 on/off

Life time and on/off
50.000h
>25.000 on/off

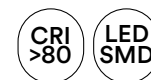

technical information **MAXWELL**



Lampada lineare in alluminio con adattatore trifase.
Linear aluminum lamp with three-phase adapter.



	colour temp.	colour
MAXWELL-W-25C 8031414884056	3300 K	White
lumen	3300 lm	
MAXWELL-W-25M 8031414884049	3300 K	White
lumen	3300 lm	
MAXWELL-B-25C 8031414884070	3300 K	Black
lumen	3300 lm	
MAXWELL-B-25M 8031414884063	3300 K	Black
lumen	3300 lm	

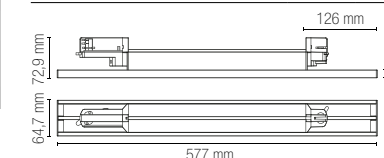

Fotometria del prodotto / Photometric curve

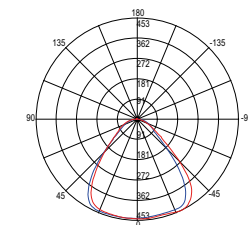

MAXWELL-25
watt 25W
beam angle 90°



	colour temp.	colour
MAXWELL-W-48C 8031414884018	6500 K	White
lumen	6500 lm	
MAXWELL-W-48M 8031414884001	6500 K	White
lumen	6500 lm	
MAXWELL-B-48C 8031414884032	6500 K	Black
lumen	6500 lm	
MAXWELL-B-48M 8031414884025	6500 K	Black
lumen	6500 lm	

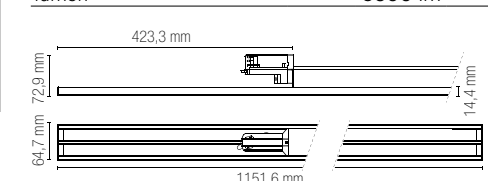

Fotometria del prodotto / Photometric curve

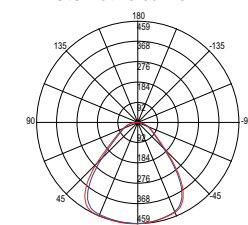

MAXWELL-48
watt 48W
beam angle 90°



Interruttore per regolazione potenza / Power switchable:
48W - 44W - 40W - 34W
130 LM/W

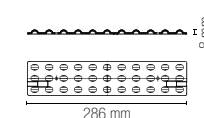

Accessori non inclusi / Not included accessories

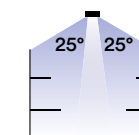

BUSMAX-LENS-25
8031414884117

Lente per doppio fascio luminoso 25° / Double lens 25°

Per i modelli **MAXWELL 25** occorrono 2 pezzi per l'intera lampada / 2 pieces need for the whole **MAXWELL 25** models

Per i modelli **MAXWELL 48** occorrono 4 pezzi per l'intera lampada / 4 pieces need for the whole **MAXWELL 48** models

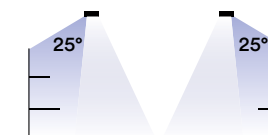

BUSMAX-LENS-RL
8031414884124

Lente fascio di luce asimmetrica 25° sx-dx / Asymmetric lens 25° sx-dx

Per i modelli **MAXWELL 25** occorrono 2 pezzi per l'intera lampada / 2 pieces need for the whole **MAXWELL 25** models

Per i modelli **MAXWELL 48** occorrono 4 pezzi per l'intera lampada / 4 pieces need for the whole **MAXWELL 48** models

SISTEMA BINARI / TRACK LIGHTS
In.tec light

Trifase / Three-phase

HELP TRACK

Lampade di emergenza LED in policarbonato per sistema binario trifase.

LED emergency lamps in polycarbonate for three-phase track system.

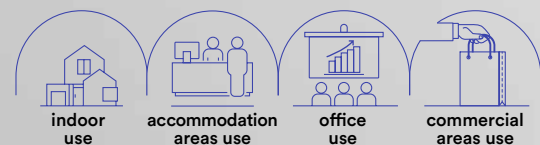

technical information **HELP TRACK**



Materiale
policarbonato

Colore
bianco
nero



Temperatura colore
4000K



Material
policarbonato

Colour
white
black



Colour temperature
4000K



LED-HELP-W-TRACK

8031414884179

lumen

colour temp. | colour



250 lm

LED-HELP-B-TRACK

8031414884162

lumen



250 lm



watt

2W

beam angle

140°

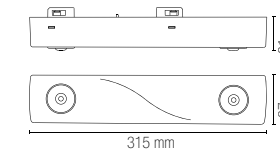

LiFePO4 3.2V 3200mAh

Batteria per emergenza inclusa /
Included emergency battery







SISTEMA BINARI / TRACK LIGHTS

In.tec light

TRACK

Binari ed accessori.













Track rail and components.

	LED-TRACK-1M 8031439221263 Binari elettrificati trifase in alluminio bianco da un 1 m con tappi inclusi.	1 m track rail in white aluminum with three-phase adaptor and endcap included.	
	LED-TRACK-2M 8031440360340 Binari elettrificati trifase in alluminio bianco da 2 m con tappi inclusi.	2 m track rail in white aluminum with three-phase adaptor and endcap included.	
	LED-TRACK-3M 8031440360357 Binari elettrificati trifase in alluminio bianco da 3 m con tappi inclusi.	3 m track rail in white aluminum with three-phase adaptor and endcap included.	
	LED-TRACK-PL 8031440358668 Kit 2 pz. Basette bianche per binario guida trifase.	Kit 2 pcs. white base for track rail three-phase.	
	LED-TRACK-BASE 8031440361668 Base tonda bianca per faro adattatore trifase (adatto per EXPRESS, ROCKET, SQUIB, OBOE).	White round base for track lamp with three-phase adaptor (useful items EXPRESS, ROCKET, SQUIB, OBOE).	
	LED-TRACK-CAP 8031414866229 Tappo per binario trifase bianco.	White cap for three-phase track rail.	
	LED-TRACK-ADAT 8031414866410 Adattatore bianco per binario trifase.	White adapt for three-phase track rail.	
	LED-TRACK-S-1,5 8031440359061 Sistema sospensione 1,5 m per binari bianco.	White suspension 1,5 m for track rail.	
	LED-TRACK-S-3 8031440359047 Sistema sospensione 3 m per binari bianco.	White suspension 3 m for track rail.	

	LED-TRACK-1M NERO 8031440360425 Binari elettrificati trifase in alluminio nero da un 1 m con tappi inclusi.	1 m track rail in black aluminum with three-phase adaptor and endcap included.	
	LED-TRACK-2M NERO 8031440360364 Binari elettrificati trifase in alluminio nero da 2 m con tappi inclusi.	2 m track rail in black aluminum with three-phase adaptor and endcap included.	
	LED-TRACK-3M NERO 8031440360371 Binari elettrificati trifase in alluminio nero da 3 m con tappi inclusi.	3 m track rail in black aluminum with three-phase adaptor and endcap included.	
	LED-TRACK-PL NERO 8031440358699 Kit 2 pz. basette nere per binario guida trifase.	Kit 2 pcs. black base for track rail three-phase.	
	LED-TRACK-BASE NERO 8031440361675 Base tonda nera per faro adattatore trifase (adatto per EXPRESS, ROCKET, SQUIB, OBOE).	Black round base for track lamp with three-phase adaptor (useful items EXPRESS, ROCKET, SQUIB, OBOE).	
	LED-TRACK-CAP NERO 8031414866205 Tappo per binario trifase nero.	Black cap for three-phase track rail.	
	LED-TRACK-ADAT NERO 8031414866397 Adattatore nero per binario trifase.	Black adapt for three-phase track rail.	
	LED-TRACK-S-1,5 NERO 8031440359078 Sistema sospensione 1,5 m per binari nero.	Black suspension 1,5 m for track rail.	
	LED-TRACK-S-3 NERO 8031440359054 Sistema sospensione 3 m per binari nero.	Black suspension 3 m for track rail.	

TRACK

Binari ed accessori.
Track rail and components.

	LED-TRACK-I-MINI 8031440358705 Connettore lineare mini bianco a scomparsa per sistema binari trifase.	White mini invisible connector for three-phase track rail system.	
	LED-TRACK-NEST 8031440311564 Innesto bianco sinistro per binari guida entrata L N + cavo di terra per circuito a trifase.	White recess power connector left side for three-phase track rail, L N input + ground cable for three-phase circuit.	
	LED-TRACK-NEST-R 8031440359009 Innesto bianco destro per binari guida entrata L N + cavo di terra per circuito a trifase.	White recess power connector right side for three-phase track rail, L N input + ground cable for three-phase circuit.	
	LED-TRACK-I 8031440311526 Connettore bianco lineare per binari sistema trifase.	White straight connector for three-phase track rail system.	
	LED-TRACK-FLEX 8031440359085 Connettore bianco flessibile per sistema trifase.	White flexible power connector for three-phase track rail system.	
	LED-TRACK-X 8031439231262 Connettore a croce bianco per sistema trifase.	White cross connector for three-phase system.	
	LED-TRACK-L-R 8031440358972 Connettore bianco track destro a L per binari guida trifase.	White L connector right side for three-phase track rail system.	
	LED-TRACK-L 8031439241261 Connettore bianco track sinistro a L per binari guida trifase.	White L connector left side for three-phase track rail system.	

	LED-TRACK-I-MINI NERO 8031440357845 Connettore lineare mini nero a scomparsa per sistema binari trifase.	Black mini invisible connector for three phase track rail system.	
	LED-TRACK-NEST NERO 8031440360418 Innesto nero sinistro per binari guida entrata L N + cavo di terra per circuito a trifase.	Black recess power connector left side for three-phase track rail, L N input + ground cable for three-phase circuit.	
	LED-TRACK-NEST-R NERO 8031440359016 Innesto nero destro per binari guida entrata L N + cavo di terra per circuito a trifase.	Black recess power connector right side for three-phase track rail, L N input + ground cable for three-phase circuit.	
	LED-TRACK-I NERO 8031440360432 Connettore nero lineare per binari sistema trifase.	Black straight connector for three-phase track rail system.	
	LED-TRACK-FLEX NERO 8031440359030 Connettore nero flessibile per sistema trifase.	Black flexible power connector for three-phase track rail system.	
	LED-TRACK-X NERO 8031440360395 Connettore a croce nero per sistema trifase.	Black cross connector for three-phase system.	
	LED-TRACK-L-R NERO 8031440359023 Connettore nero track destro a L per binari guida trifase.	Black L connector right side for three-phase track rail system.	
	LED-TRACK-L NERO 8031440360401 Connettore nero track sinistro a L per binari guida trifase.	Black L connector left side for three-phase track rail system.	

TRACK

Binari ed accessori.

Track rail and components.



LED-TRACK-T
8031440311571

Connettore bianco destro a T per binari guida entrata L N + cavo di terra per circuito trifase.

Right white T connector for L N input guide rails + ground cable for three-phase system.



LED-TRACK-T-L1
8031440358989

Connettore bianco sinistro a T per binari guida entrata L N + cavo di terra per circuito trifase.

Left white T connector for L N input guide rails + ground cable for three-phase system.



LED-TRACK-T-R1
8031440357449

Connettore bianco destro a T per binari guida entrata L N + cavo di terra per circuito trifase.

Right white T connector for L N input guide rails + ground cable for three-phase system.



LED-TRACK-T-R2
8031440357487

Connettore bianco a T per binari guida entrata L N + cavo di terra per circuito trifase.

White T connector for L N input guide rails + ground cable for three-phase circuit.



LED-TRACK-T NERO
8031440360388

Connettore nero destro a T per binari guida entrata L N + cavo di terra per circuito trifase.

Right black T connector for L N input guide rails + ground cable for three-phase system.



LED-TRACK-T-L1 NERO
8031440358996

Connettore nero sinistro a T per binari guida entrata L N + cavo di terra per circuito trifase.

Left black T connector for L N input guide rails + ground cable for three-phase system.



LED-TRACK-T-R1 NERO
8031440357456

Connettore nero destro a T per binari guida entrata L N + cavo di terra per circuito trifase.

Right black T connector for L N input guide rails + ground cable for three-phase system.



LED-TRACK-T-R2 NERO
8031440357661



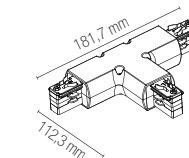

Connettore nero a T per binari guida entrata L N + cavo di terra per circuito trifase.









Black T connector for L N input guide rails + ground cable for three-phase circuit.

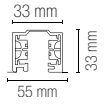

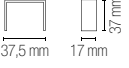
TRACK

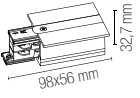
Binari ed accessori.
Track rail and components.

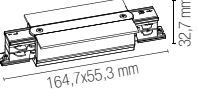
	LED-TRACK-1M-INC 8031440361804 Binario trifase ad incasso in alluminio bianco 1 m.	Recessed track light in white aluminum 1 m.	
	LED-TRACK-2M-INC 8031440361811 Binario trifase ad incasso in alluminio bianco 2 m.	Recessed track light in white aluminum 2 m.	
	INC-TRACK-STAFFE 8031414879700 Kit 2pz staffe zincate per binario incasso	Kit 2pcs metal bracket for recessed track rail	
	INC-TRACK-NEST 8031414871193 Innesto sinistro per binario ad incasso trifase bianco.	White recess power connector left side for three-phase track rail.	⊥
	INC-TRACK-NEST-R 8031414871179 Innesto destro per binario ad incasso trifase bianco.	White recess power connector right side for three-phase track rail in back version.	⊥
	INC-TRACK-I 8031414871254 Connettore bianco lineare ad incasso per binari trifase.	White recess straight connection for three-phase track rail system.	⊥
	INC-TRACK-L-R 8031414871216 Connettore bianco ad incasso destro a L per binari trifase.	White recess L connector right side for three-phase track rail system.	⊥
	INC-TRACK-L 8031414871230 Connettore bianco ad incasso sinistro a L per binari trifase.	White recess L connector left side for three-phase track rail system.	⊥

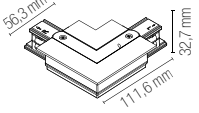
	LED-TRACK-1M-INC NERO 8031414864836 Binario trifase ad incasso in alluminio nero 1 m.	Recessed track light in black aluminum 1 m.	
	LED-TRACK-2M-INC NERO 8031414864058 Binario trifase ad incasso nero in alluminio 2 m.	Recessed track light in black aluminum 2 m.	
	INC-TRACK-STAFFE 8031414879700 Kit 2pz staffe zincate per binario incasso	Kit 2pcs metal bracket for recessed track rail	
	INC-TRACK-NEST NERO 8031414871209 Innesto sinistro per binario ad incasso trifase nero.	Black recess power connector left side for three-phase track rail.	
	INC-TRACK-NEST-R NERO 8031414871186 Innesto destro per binario ad incasso trifase nero.	Black recess power connector right side for three-phase track rail in back version.	
	INC-TRACK-I NERO 8031414871261 Connettore nero lineare ad incasso per binari trifase.	Black recess straight connection for three-phase track rail system.	
	INC-TRACK-L-R NERO 8031414871223 Connettore nero ad incasso destro a L per binari trifase.	Black recess L connector right side for three-phase track rail system.	
	INC-TRACK-L NERO 8031414871247 Connettore nero ad incasso sinistro a L per binari trifase.	Black recess L connector left side for three-phase track rail system.	

TRUNKING SYSTEM BUSBAR



Schema di montaggio sistema binari.
Assembling technical sheet track rail system.

TRUNKING SYSTEM BUSBAR

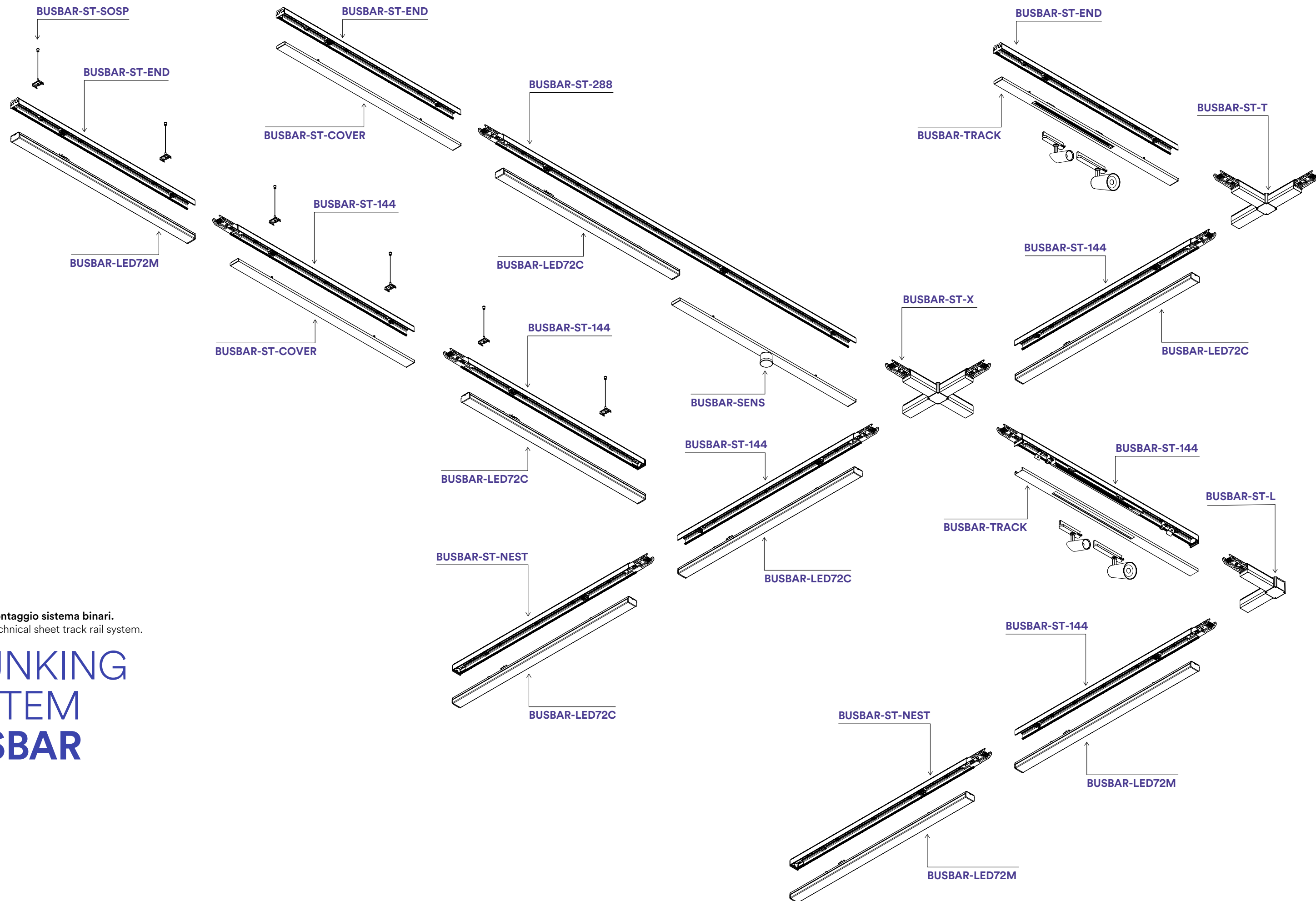

Trunking System

BUSBAR

Sistema trunking lineare.
Trunking linear system.

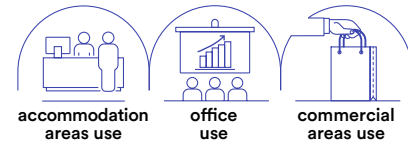

technical information **BUSBAR**



Materiale
alluminio

Colore
bianco

Temperatura colore
3000K / 4000K



Driver
integrato

Durata e on/off
50.000h
>25.000 on/off

Material
aluminum

Colour
white

Colour temperature
3000K / 4000K



Driver
built-in

Life time and on/off
50.000h
>25.000 on/off



Antipolvere e antispruzzo /
Dustproof and splashproof

Led rivestiti contro le influenze esterne /
Coated LEDs against external influences

Montaggio senza attrezzi /
Toolless mounting



Sistema di fissaggio a soffitto o a sospensione /
Ceiling mount or pendant fixing system



Estensibile grazie ai moduli in 2 misure /
Extendable thanks to the extruded aluminum modules



Sistema easy di aggancio binari /
Track rail easy connection system



7 cavi L1 L2 L3 N E D+ D- trifase più dimmer /
7 wire connection system L1 L2 L3 N E D+ D- three-phase + dimmer



Sistema easy di fissaggio della lampada /
Lamp easy installation system

Lenti per diversi fasci di luce / Different beam angles optional lens

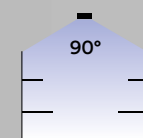

Lente inclusa /
Included lens

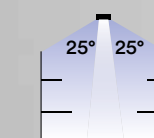

Lente opzionale
doppio fascio luminoso 25° /
Optional lens double lens 25°

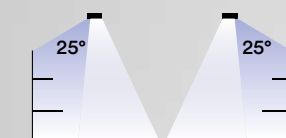

Lente opzionale
fascio di luce asimmetrico 25° sx-dx /
Optional lens asymmetric lens 25° sx-dx

SISTEMA BINARI / TRACK LIGHTS
In.tec light

BUSBAR

Lampada lineare per sistema trunking.
Linear lamp for trunking system.

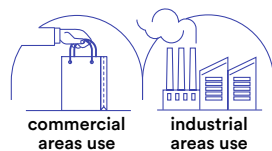

commercial areas use

industrial areas use



technical information **BUSBAR**



- Materiale**
alluminio
- Colore**
bianco
- Temperatura colore**
3000K / 4000K
- Driver**
integrato
- Durata e on/off**
50.000h
>25.000 on/off
- Material**
aluminum
- Colour**
white
- Colour temperature**
3000K / 4000K
- Driver**
built-in
- Life time and on/off**
50.000h
>25.000 on/off



	colour temp.	colour		colour temp.	colour
BUSBAR-LED72C 8031414883936	9340 lm		BUSBAR-LED72M-HELP 8031414898367	9340 lm	
BUSBAR-LED72M 8031414883929	9340 lm				
watt		72W	emergency light		3 h - 600 lm
beam angle		90°	watt		4W
			beam angle		90°

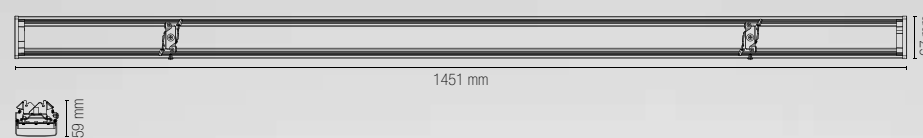

Funzione MAINTAIN
sempre accesa /
MAINTAIN
function always on

Funzione NON-MAINTAIN
emergenza /
NON-MAINTAIN function
only emergency

Compatibile con altri sistemi trunking in commercio / Compatible with other trunking systems



Fotometria del prodotto / Photometric curve

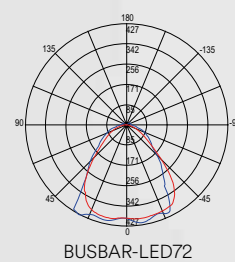

Accessori non inclusi / Not included accessories

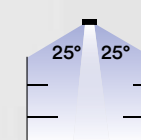

BUSMAX-LENS-25
8031414884117

Lente per doppio fascio luminoso 25° /
Double lens 25°

Per tutta la lampada
BUSBAR occorrono 5 pezzi /
5 pieces need for the
whole **BUSBAR** lamp

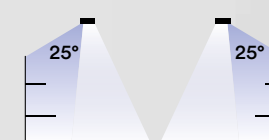

BUSMAX-LENS-RL
8031414884124





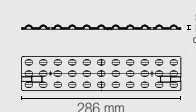





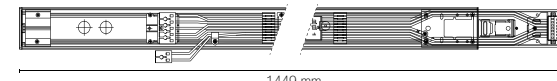

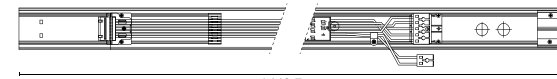

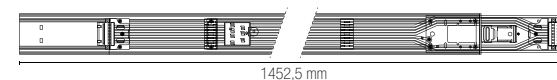

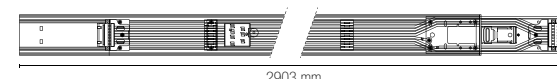
Lente fascio di luce asimmetrica 25° sx-dx /
Asymmetric lens 25° sx-dx

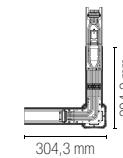
Per tutta la lampada
BUSBAR occorrono 5 pezzi /
5 pieces need for the
whole **BUSBAR** lamp

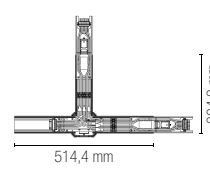

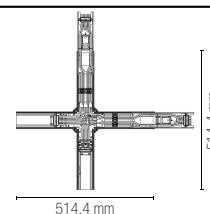
BUSBAR

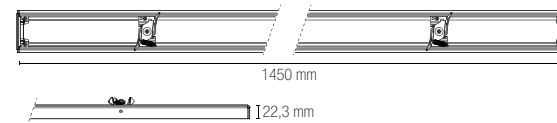
Sistema blindosbarra lineare per installazione a sospensione e plafoniera.
Busways linear system bar for suspended installation and ceiling light.

	BUSBAR-ST-NEST 8031414883943 Binario innesto 7 cavi per alimentazione. Feed trunking with 7 input wire.		1449 mm
	BUSBAR-ST-END 8031414883950 Binario terminale 7 cavi con sistema di connessione multipla. Terminal track rail 7 cables with multiple connection system.		1449,7 mm
	BUSBAR-ST-144 8031414883967 Binario intermedio 7 cavi da 145 cm. Intermediate trunking with 7 wire of 145 cm.		1452,5 mm
	BUSBAR-ST-288 8031414883974 Binario intermedio 7 cavi da 290 cm. Intermediate trunking with 7 wire of 290 cm.		2903 mm
	BUSBAR-ST-L 8031414884087 Connettore a L 7 cavi. L connector with 7 wires.		304,3 mm
	BUSBAR-ST-T 8031414884100 Connettore a T 7 cavi. T connector with 7 wires.		514,4 mm
	BUSBAR-ST-X 8031414884094 Connettore a X 7 cavi. X connector with 7 wires.		514,4 mm
	BUSBAR-ST-COVER 8031414883981 Cover di alluminio bianco. White aluminum cover.		1450 mm 122,3 mm
	LED-SENSOR-REMOTE 8031414879717 Radiocomando per sensori industriali. Industrial sensor remote control.		

BUSBAR-SENS

1 / function

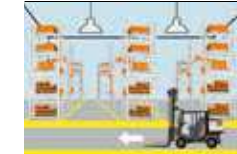

In un ambiente sufficientemente luminoso la lampada non si accende anche se viene rilevato movimento.

With sufficient ambient light, the light will not be switched on even if with motion signal.



In un ambiente poco luminoso il sensore accende la lampada non appena viene rilevato un movimento.

With insufficient ambient light, the sensor switches on the light when motion is detected.



Trascorso il tempo di attesa, il sensore spegne la lampada quando non viene rilevato movimento.

After elapse of hold time, the sensor switches off the light when no motion is detected.

BUSBAR-SENS

2 / function



Se non viene rilevato movimento la lampada rimane ad un basso livello di luminosità.

If there is motion detected, the light will be remained at a low light level all the time.



Quando viene rilevato movimento, il sensore porta la lampada al 100% di luminosità.

When motion is detected, the sensor will switch on the light to 100% brightness.



Trascorso il tempo di attesa, il sensore attenua la luce all'attuale livello di luminosità se non è rilevato movimento.

After elapse of hold time, the sensor dims the light at present low light level if no motion is detected.

BUSBAR-SENS

3 / function

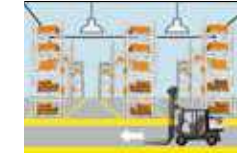

In un ambiente sufficientemente luminoso la lampada non si accende anche se viene rilevato movimento.

With sufficient ambient light, the light will not be switched on even if with motion signal.



In un ambiente poco luminoso il sensore accende la lampada non appena viene rilevato un movimento.

With insufficient ambient light, the sensor switches on the light when motion is detected.

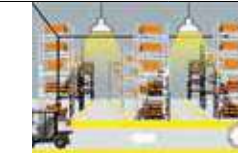





Trascorso il tempo di attesa, il sensore attenua la luce all'attuale livello di luminosità se non è rilevato movimento.

After elapse of hold time, the sensor dims the light at present low light level if no motion is detected.

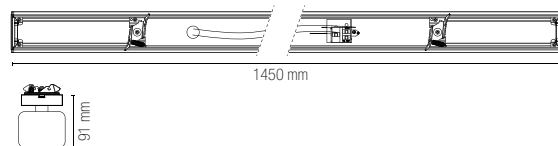

Trascorso il tempo di standby il sensore spegne la lampada se non è rilevato movimento.

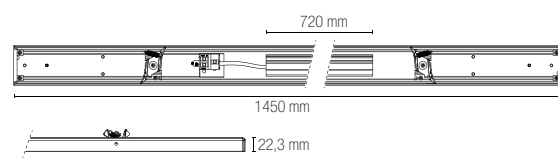
After elapse of standby period, the sensor switches off the light if no motion is detected.

	BUSBAR-SENS 8031414884131 Cover elettrificata con sensore di movimento e crepuscolare da 3 funzioni incluso. Electrified cover with motion and crepuscular 3 functions sensor.		1450 mm 91 mm
	BUSBAR-TRACK 8031414884148 Cover elettrificata con binario trifase. Electrified cover with three phase track system.		720 mm 1450 mm 122,3 mm
	BUSBAR-FIX 8031414884155 Kit 2 pz staffe per fissaggio a plafoniera. Bracket kit 2 pcs for ceiling mounting.		
	BUSBAR-ST-SOSP 8031414883998 Kit 2 pz cavi per binario a sospensione con cavo da 5 m. Kit 2 pcs cables for suspension track with 5 m cable.		

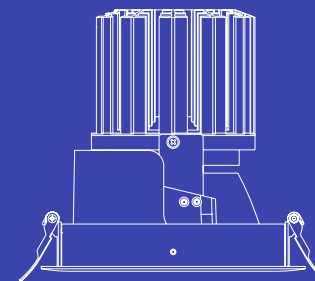

INCASSI

RECESSED LAMPS

APOLLO

Faretto ad incasso antiriflesso con struttura in alluminio e finitura con bordo bianco ed interno nero satinato. Luci spot con doppia orientabilità.
Anti-glare recessed spotlight with aluminum structure and finish with white border and satin black interior. Spot lights with double orientability.

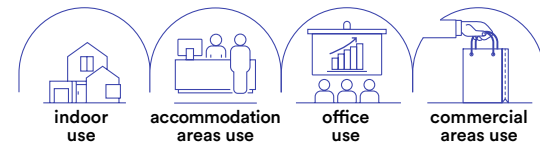

Materiale
alluminio

Colore
bordo bianco
e interno
nero satinato



Temperatura colore
3000K / 4000K

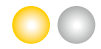

Driver
incluso

Material
aluminum

Colour
body with white
edge and
satin black internal



Colour temperature
3000K / 4000K



Driver
included



collection **APOLLO**

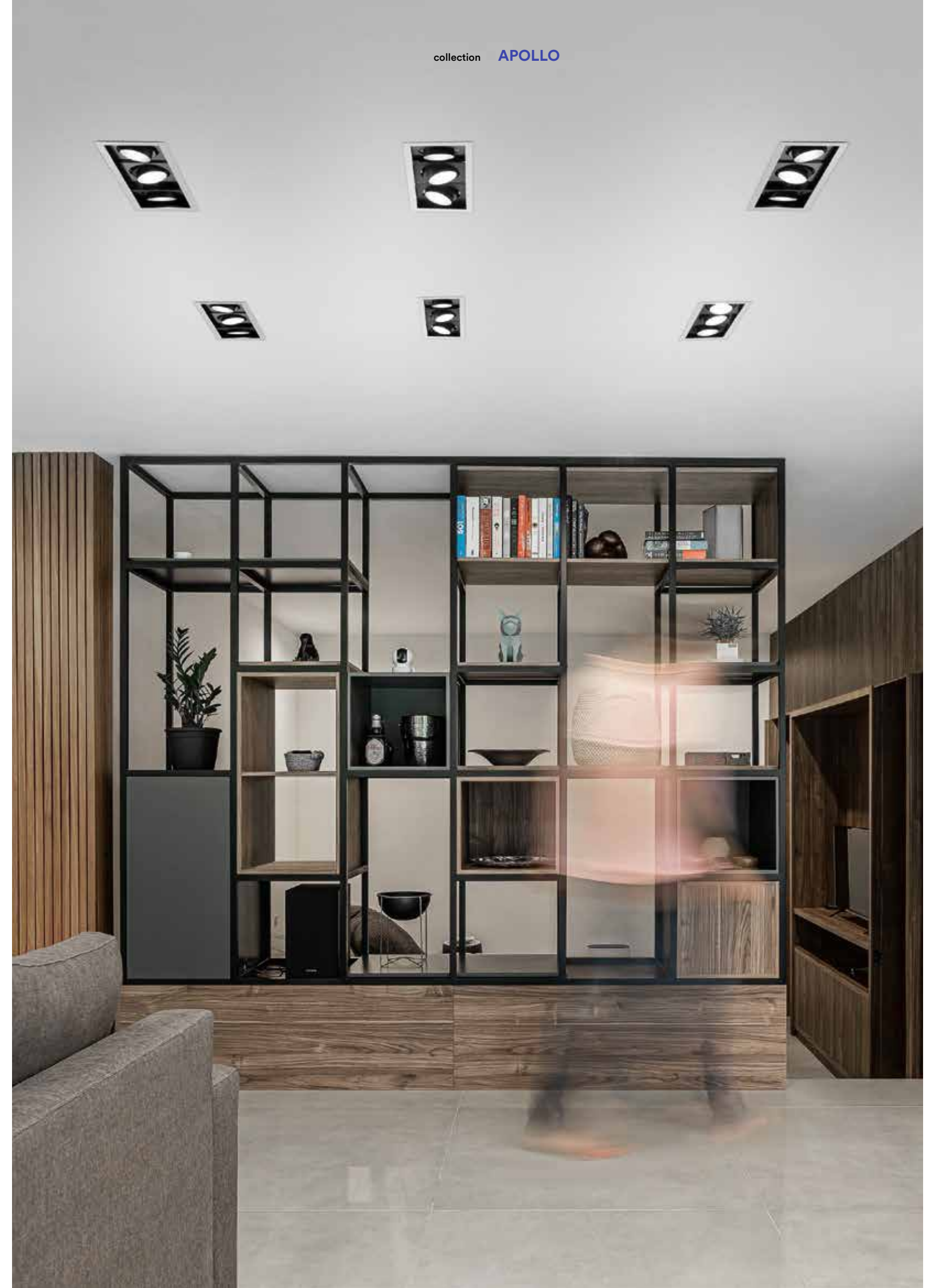



INC-APOLLO-1X10C 8031440360623	colour temp.	colour
lumen	1000 lm	
INC-APOLLO-1X10M 8031440360630	colour temp.	colour
lumen	1000 lm	

watt	1 × 10W
beam angle	40°
pf	-
	100 × 100 mm

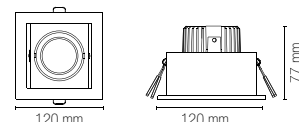

INC-APOLLO-1X20C 8031440360692	colour temp.	colour
lumen	2000 lm	
INC-APOLLO-1X20M 8031440360708	colour temp.	colour
lumen	2000 lm	

watt	1 × 20W
beam angle	40°
pf	-
	125 × 125 mm

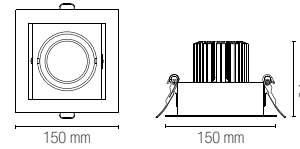

INC-APOLLO-1X30C 8031440360753	colour temp.	colour
lumen	2900 lm	
INC-APOLLO-1X30M 8031440360760	colour temp.	colour
lumen	2900 lm	

watt	1 × 30W
beam angle	40°
pf	0.90
	175 × 175 mm

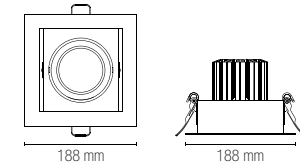

INC-APOLLO-1X45C 8031440360777	colour temp.	colour
lumen	4500 lm	
INC-APOLLO-1X45M 8031440360784	colour temp.	colour
lumen	4500 lm	

watt	1 × 45W
beam angle	40°
pf	0.90
	175 × 175 mm

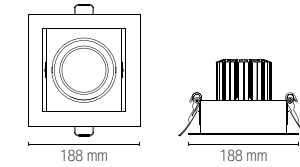

Fotometria del prodotto / Photometric curve

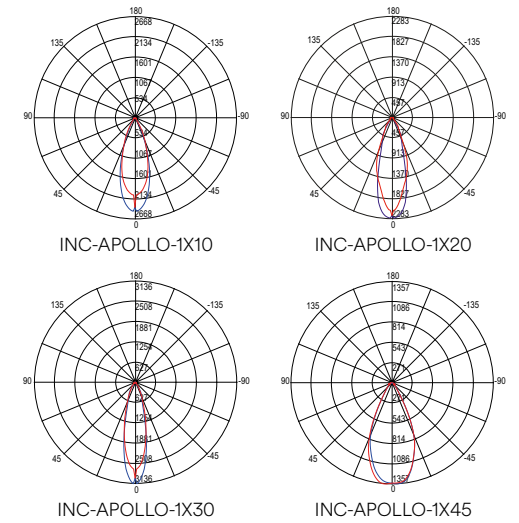

INC-APOLLO-2X10C 8031440360647	colour temp.	colour
lumen	2000 lm	
INC-APOLLO-2X10M 8031440360654	colour temp.	colour
lumen	2000 lm	

watt	2 × 10W
beam angle	40°
pf	-
	190 × 100 mm

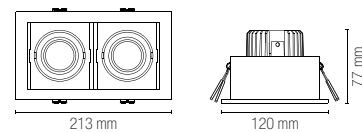

INC-APOLLO-2X20C 8031440360715	colour temp.	colour
lumen	4000 lm	
INC-APOLLO-2X20M 8031440360722	colour temp.	colour
lumen	4000 lm	

watt	2 × 20W
beam angle	40°
pf	-
	245 × 125 mm

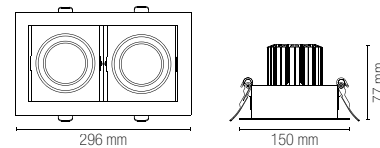

INC-APOLLO-2X30C 8031440360791	colour temp.	colour
lumen	5800 lm	
INC-APOLLO-2X30M 8031440360807	colour temp.	colour
lumen	5800 lm	

watt	2 × 30W
beam angle	40°
pf	0.90
	320 × 175 mm

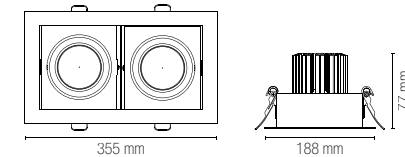

INC-APOLLO-2X45C 8031440360814	colour temp.	colour
lumen	9000 lm	
INC-APOLLO-2X45M 8031440360821	colour temp.	colour
lumen	9000 lm	

watt	2 × 45W
beam angle	40°
pf	0.90
	320 × 175 mm

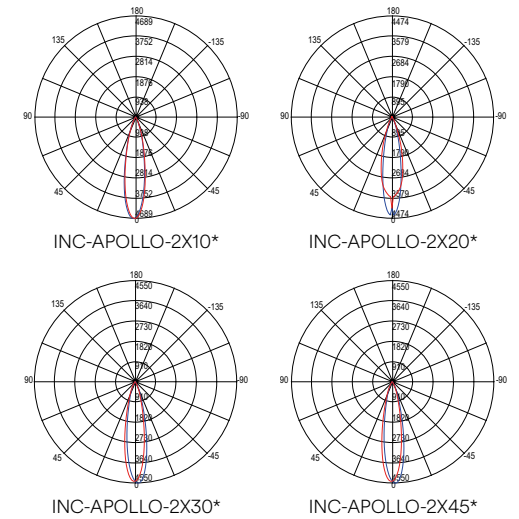
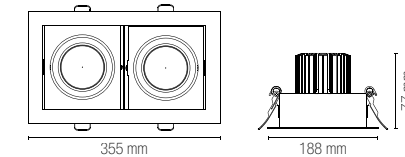

INC-APOLLO-3X10C 8031440360661	colour temp.	colour
lumen	3000 lm	
INC-APOLLO-3X10M 8031440360678	colour temp.	colour
lumen	3000 lm	

watt	3 × 10W
beam angle	40°
pf	-
	290 × 100 mm

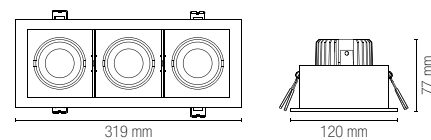

INC-APOLLO-3X20C 8031440360746	colour temp.	colour
lumen	6000 lm	
INC-APOLLO-3X20M 8031440360739	colour temp.	colour
lumen	6000 lm	

watt	3 × 20W
beam angle	40°
pf	-
	355 × 125 mm

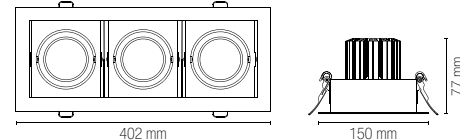

INC-APOLLO-3X30C 8031440360845	colour temp.	colour
lumen	8700 lm	
INC-APOLLO-3X30M 8031440360838	colour temp.	colour
lumen	8700 lm	

watt	3 × 30W
beam angle	40°
pf	0.90
	475 × 175 mm

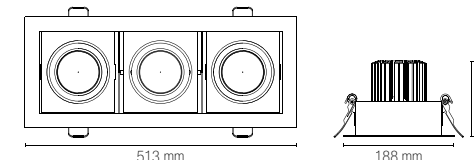

INC-APOLLO-3X45C 8031440360852	colour temp.	colour
lumen	13500 lm	
INC-APOLLO-3X45M 8031440360869	colour temp.	colour
lumen	13500 lm	

watt	3 × 45W
beam angle	40°
pf	0.90
	475 × 175 mm

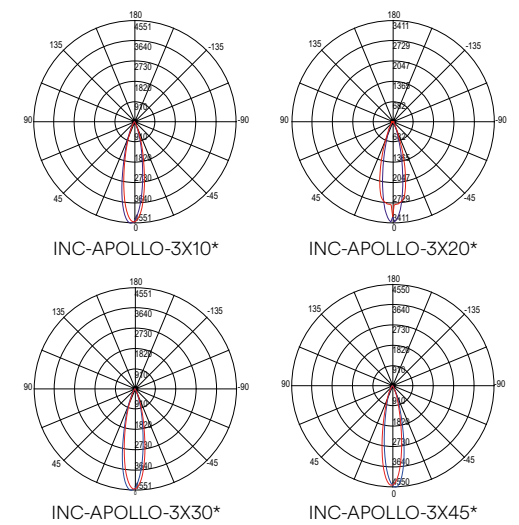
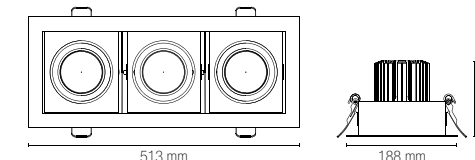

Le curve fotometriche rappresentano il singolo modulo LED per ogni elemento / Above photometric curve represent the single module of each element

OUTSIDER

Faretto ad incasso antiriflesso con struttura in alluminio, finitura bianco opaco e bordatura interna nera. Luci spot con testa estraibile e orientabile a 350°.
Anti-glare recessed spotlight with aluminum structure, matt white finish and black inner border. Spot lights with pull-out head and adjustable to 350.

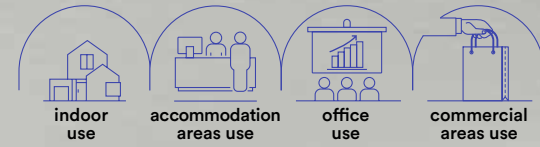

Materiale
alluminio

Material
aluminum

Colore

bianco opaco
con bordatura
interna nera

Colour

matt white
color and black
internal ring



Temperatura colore
3000K / 4000K



Colour temperature
3000K / 4000K



Driver
incluso













Driver
included

collection **OUTSIDER**



In.tec light **INCASSI / RECESSED LAMPS**





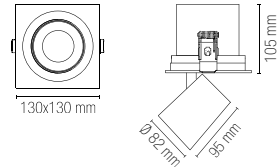
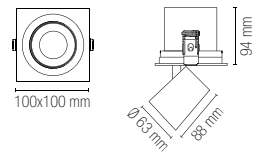



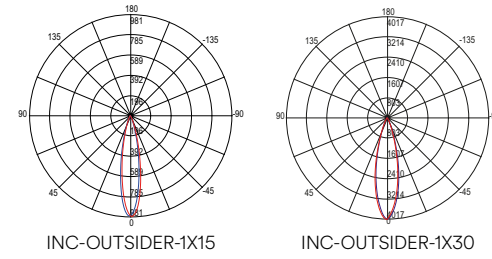



	colour temp.	colour		colour temp.	colour
INC-OUTSIDER-1X15C 8031414864225			INC-OUTSIDER-1X30C 8031414864256		
lumen	1375 lm		lumen	3100 lm	
INC-OUTSIDER-1X15M 8031414864119			INC-OUTSIDER-1X30M 8031414864133		
lumen	1375 lm		lumen	3100 lm	
watt	1 x 15W		watt	1 x 30W	
beam angle	24°		beam angle	24°	
pf	-		pf	0.90	
	90 x 90 mm			116 x 116 x pr. 110 mm	









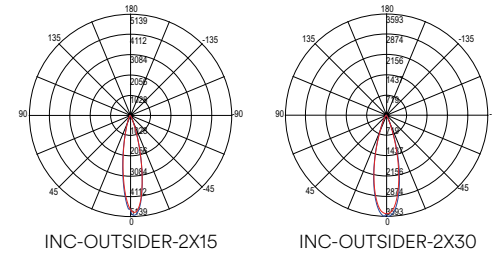
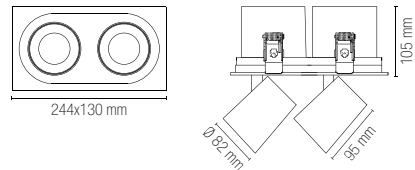
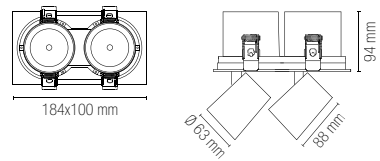



Fotometria del prodotto / Photometric curve



	colour temp.	colour		colour temp.	colour
INC-OUTSIDER-2X15C 8031414864232			INC-OUTSIDER-2X30C 8031414864263		
lumen	2750 lm		lumen	6200 lm	
INC-OUTSIDER-2X15M 8031414864126			INC-OUTSIDER-2X30M 8031414864140		
lumen	2750 lm		lumen	6200 lm	
watt	2 x 15W		watt	2 x 30W	
beam angle	24°		beam angle	24°	
pf	-		pf	0.90	
	174 x 90 x pr. 96 mm			230 x 116 x pr. 110 mm	



	colour temp.	colour		colour temp.	colour
INC-OUTSIDER-3X15C 8031414864249			INC-OUTSIDER-3X30C 8031414864270		
lumen	4125 lm		lumen	9300 lm	
INC-OUTSIDER-3X15M 8031414864102			INC-OUTSIDER-3X30M 8031414864157		
lumen	4125 lm		lumen	9300 lm	
watt	3 x 15W		watt	3 x 30W	
beam angle	24°		beam angle	24°	
pf	-		pf	0.90	
	260 x 90 x pr. 96 mm			236 x 116 x pr. 110 mm	

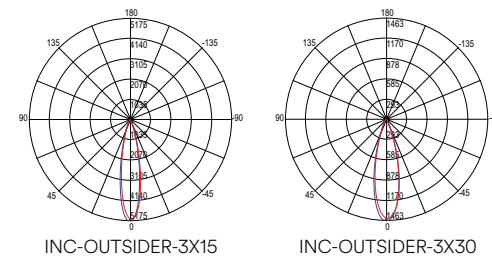
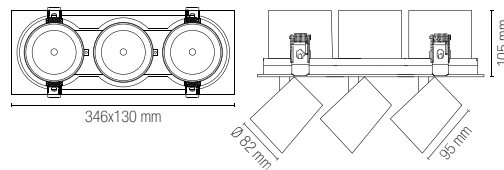
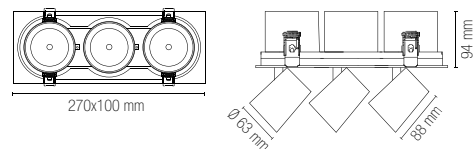

Le curve fotometriche rappresentano il singolo modulo LED per ogni elemento / Above photometric curves represent the single module of each element

DELTA INC

Faretto ad incasso antiriflesso con struttura in alluminio, finitura bianco satinato e riflettore silver. Luci spot con testa estraibile e orientabile. Disponibile anche nella colorazione per la linea food.

Anti-glare recessed spotlight with aluminum structure, satin white finish and silver reflector. Spot lights with removable and adjustable head. Also available for lighting food line.

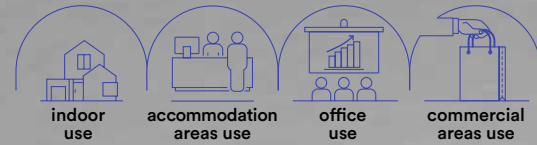

Materiale
alluminio

Colore
bianco satinato
e riflettore silver

Temperatura colore
3000K / 4000K

Temperatura colore selezionabile
3000K / 4000K / 6500K

Driver
incluso

Material
aluminum

Colour
satin white and
silver reflector

Colour temperature
3000K / 4000K

Selectable color temperature
3000K / 4000K / 6500K

Driver
included



technical information **DELTA**



INC-DELTA-20C
8031414883523
lumen 2600 lm

colour temp.	colour

watt 20W
beam angle 24°
pf -
Ø 128 mm

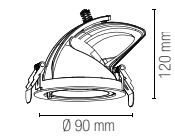

Fotometria del prodotto /
Photometric curve

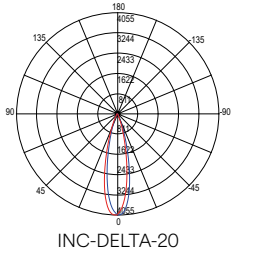

INC-DELTA-30C
8031414883271
lumen 3860 lm

colour temp.	colour

watt 30W
beam angle 24°
pf 0.90
Ø 150 mm

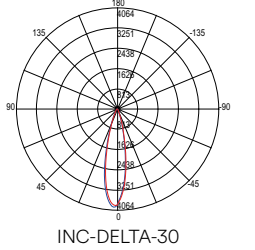
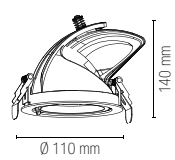

INC-DELTA-38
8031414893546
lumen 4300 lm

colour temp.	colour

watt 38W
beam angle 60°
pf 0.90
Ø 160 mm

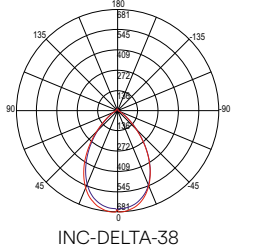
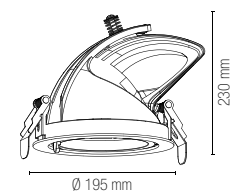

illuminazione per generi alimentari /
Food lighting



INC-DELTA-30BR
8031414883417
lumen 3155 lm
K 2500 K
CRI >60-63

colour temp.	colour

INC-DELTA-30RM
8031414883448
lumen 3155 lm
K 3100 K
CRI >60-63

colour temp.	colour

INC-DELTA-30FM
8031414883424
lumen 3155 lm
K 3000 K
CRI >60-63

colour temp.	colour

INC-DELTA-30FR
8031414883431
lumen 3155 lm
K 3000 K
CRI >60-63

colour temp.	colour

watt 30W
beam angle 24°
pf 0.90
Ø 150 mm

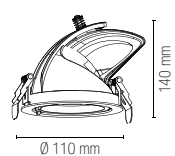

LYBRA

Faretto ad incasso rettangolare con struttura in alluminio e finitura in bianco satinato. Diffusore con orientabilità verticale. Rectangular recessed spotlight with aluminum structure and satin white finish. Diffuser with vertical orientability.

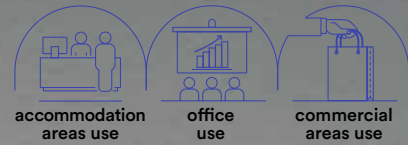

- Materiale**
alluminio + PC
- Colore**
bianco satinato
- Temperatura colore selezionabile**
3000K / 4000K / 6500K
- Driver**
incluso
- Material**
aluminum + PC
- Colour**
satin white
- Selectable color temperature**
3000K / 4000K / 6500K
- Driver**
included



	colour temp.	colour
INC-LYBRA-38	4400 lm	
8031414893553		
lumen		
watt	38W	
beam angle	120°	
pf	0.90	
	220 x 140 mm	

Fotometria del prodotto / Photometric curve

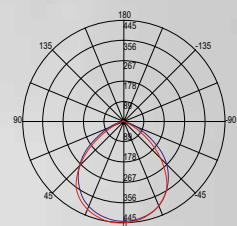

INC-LYBRA-38

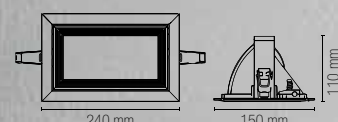

FIBRA OTTICA

Kit fibra ottica traslucente con temperatura colore RGB+4000K. Translucent fiber optic kit with color temperature RGB + 4000K.

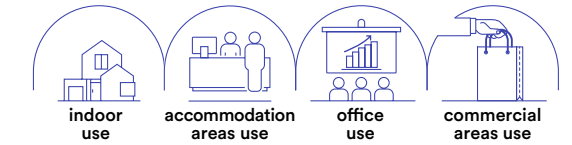

- Materiale**
fibra ottica traslucente
- Temperatura colore**
RGB + 4000K
- Driver**
incluso
- Dimmer**
dimmerabile con radiocomando
- Material**
translucent optical fiber
- Colour temperature**
RGB + 4000K
- Driver**
included
- Dimmer**
dimmable with remote control



Accessori inclusi / Included accessories



Driver radio controller

FIBRAOTTICA-LED-RGB
8031436691236

colour temp.

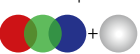

100 fiber of Ø 1mm
watt

16W

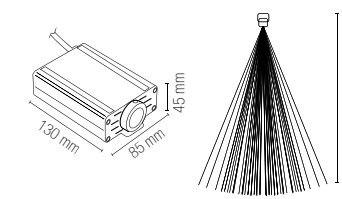

STARLIGHT STARLIGHT30



STARLIGHT

Materiale
alluminio

Colore
bianco, argento



Temperatura colore
4000K / BLU



Driver
non incluso

Material
aluminum

Colour
white, silver



Colour temperature
4000K / BLU



Driver
not included

STARLIGHT 30

Materiale
alluminio

Colore
bianco, argento



Temperatura colore
4000K



Driver
12V DC 100mA 6W

Material
aluminum

Colour
white, silver



Colour temperature
4000K



Driver
12V DC 100mA 6W

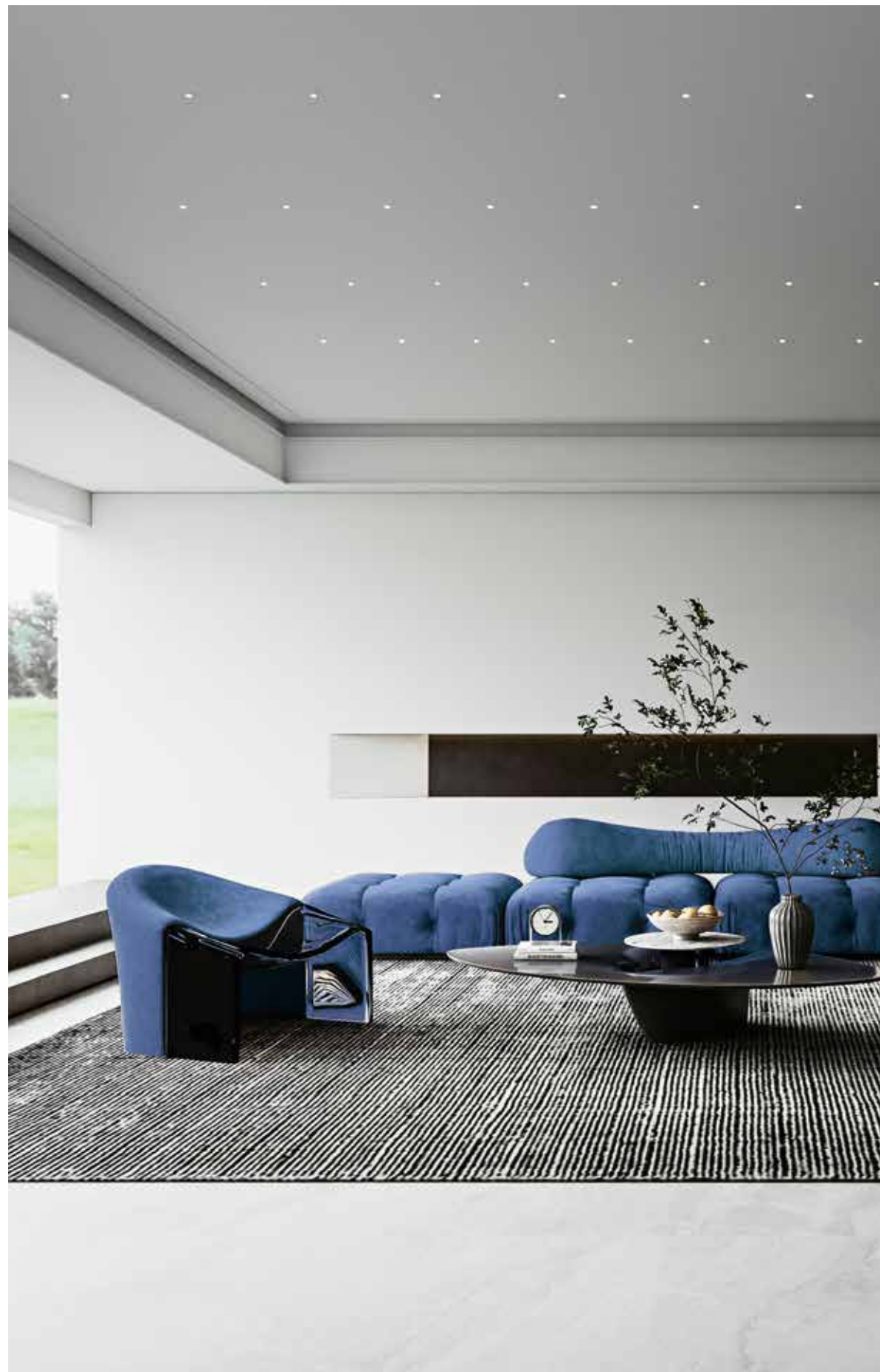

CRI
>80

technical information



STARLIGHT

Connessione in parallelo / Parallel connection



Mini faretto a incasso cielo stellato con struttura in alluminio e doppia ghiera di colore bianco o silver intercambiabile.
Downlight for decorative starlight with aluminum structure and double interchangeable ring color white or silver.

LED-STARLIGHT-W
8031440361682

lumen

LED-STARLIGHT-BLU
8031440361699

colour temp.	colour

blu

with 1 m. cable

watt

LED 0,2W



Ø 14 mm

STARLIGHT 30



Kit 30 mini faretto a incasso cielo stellato con struttura in alluminio e doppia ghiera di colore bianco o silver intercambiabile.
Kit 30 downlight for decorative starlight with aluminum structure and double interchangeable ring color white or silver.

LED-STARLIGHT-30-W
8031440357692

lumen

with 1 m. cable

watt

colour temp.	colour

LED 30 x 0,2W



Ø 14 mm

Accessori inclusi / Included accessories



Ghiera bianca intercambiabile /
White changeable ring



Ghiera silver intercambiabile /
Silver changeable ring

Accessori non inclusi / Not included accessories



LED-STARLIGHT-NEX
8031440364430

Scatola connessione per 10
teste 12V DC 1A incl. Cavo 1m. /
Box connection for 10 pcs
12V DC 1A with 1m. cable



LED-STARLIGHT-CONN
8031440364843

Connettore con singola entrata
3 uscite per kit cielo stellato
12V DC 1A incl. Cavo 1m. /
Connector one input three
output for starlight 12V
DC 1A with 1m. cable



LED-STARLIGHT-DR
8031440364447

Driver 12V DC 100mA
6W incl. Cavo 1m. /
Driver 12V DC 100mA
6W incl. 1m. cable

Fotometria del prodotto /
Photometric curve

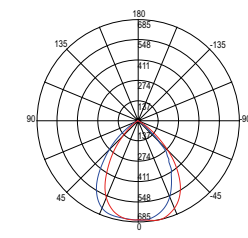

LED-STARLIGHT 0,2W

Accessori inclusi / Included accessories



Ghiera bianca intercambiabile /
White changeable ring



Ghiera silver intercambiabile /
Silver changeable ring



3 Scatole connessione per 10 teste
12V DC 1A incl. cavo 1m. /
3 Boxes connection for 10 pcs
12V DC 1A with 1m. cable



1 Connettore con singola entrata
3 uscite per kit cielo stellato
12V DC 1A incl. cavo 1m. /
1 Connector one input three
output for starlight
12V DC 1A with 1m. cable



1 Driver 12V DC 100mA
6W incl. Cavo 1m. /
1 Driver 12V DC 100mA
6W incl. 1m. cable

Fotometria del prodotto /
Photometric curve

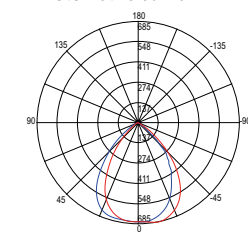

LED-STARLIGHT 0,2W

ASSO KIT 3

Kit 3 faretti da incasso con struttura in alluminio disponibile nella versione silver quadrata o rotonda.

Kit 3 recessed spotlights with aluminum structure available in silver square or round.

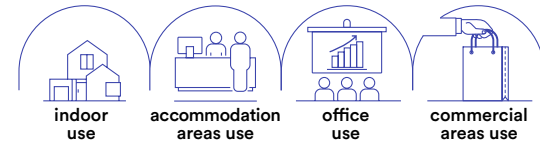

technical information **ASSO KIT 3**



Materiale
alluminio

Colore
argento



Temperatura colore
4000K



Driver
230V incluso

Material
aluminum

Colour
silver



Colour temperature
4000K



Driver
230V included



Kit 3 pz / Kit 3 pcs



INC-ASSO-Q3
8031414881628
lumen

colour temp. | colour
3x100 lm



watt LED 1W
beam angle 30°
Ø 25 mm

Kit 3 pz / Kit 3 pcs



INC-ASSO-R3
8031414881611
lumen

colour temp. | colour
3x100 lm



watt LED 1W
beam angle 30°
Ø 25 mm



Fotometria del prodotto / Photometric curve

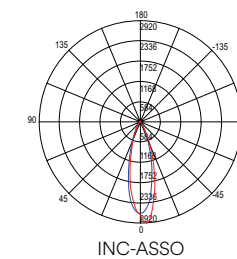

Accessori inclusi / Included accessories

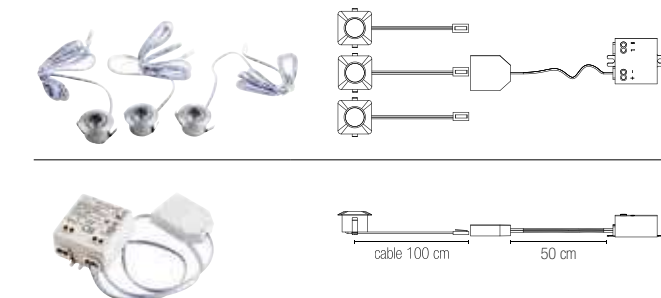

ASSO

Faretto da incasso con struttura in alluminio disponibile in bianco nero nella forma quadrata o rotonda.

Recessed spotlight with aluminum structure available in black white in square or round shape.

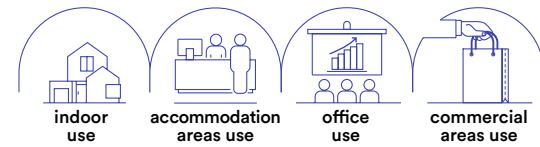

CRI >80

technical information ASSO

EASY DOMOTICA



Materiale
alluminio

Colore
bianco
nero



Temperatura colore
3000K / 4000K / BLU



Driver
DC 24V
tensione costante
non incluso

Material
aluminum

Colour
white
black



Colour temperature
3000K / 4000K



Driver
DC 24V
constant voltage
not included



1 pz / 1 pcs



INC-ASSO-Q30C

8031414881642

lumen

colour temp.



100 lm

colour



100 lm



INC-ASSO-Q30M

8031414881659

lumen



100 lm



100 lm

watt

LED 1W

beam angle

30°



Ø 25 mm

1 pz / 1 pcs



INC-ASSO-Q30C-NER

8031414881666

lumen

colour temp.



100 lm

colour



100 lm



INC-ASSO-Q30M-NER

8031414881673

lumen



100 lm



100 lm

watt

LED 1W

beam angle

30°



Ø 25 mm

1 pz / 1 pcs



INC-ASSO-R30C

8031414877829

lumen

colour temp.



100 lm

colour



100 lm

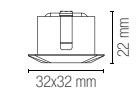

INC-ASSO-R30M

8031414877928

lumen



100 lm



100 lm

INC-ASSO-R30-BLU

8031414877935



blu



100 lm

watt

LED 1W

beam angle

30°



Ø 25 mm

1 pz / 1 pcs



INC-ASSO-R30C-NER

8031414881635

lumen

colour temp.



100 lm

colour



100 lm



INC-ASSO-R30M-NER

8031414881680

lumen



100 lm



100 lm

watt

LED 1W

beam angle

30°



Ø 25 mm

Fotometria del prodotto / Photometric curve

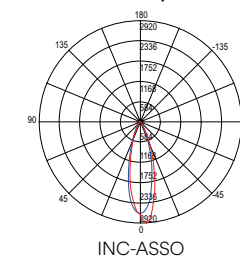

Accessori inclusi / Included accessories

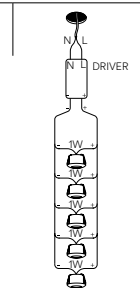
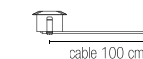

Connessione in parallelo / Parallel connection system

Driver p. 837-846
Controller pag. 848-851

DOT

Faretto da incasso con struttura in alluminio disponibile in bianco nero.

Recessed spotlight with aluminum structure available in black or white.

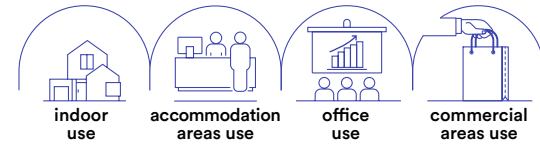

- Materiale**
alluminio + PC
- Colore**
bianco satinato
nero satinato
- Temperatura colore selezionabile**
3000K / 4000K / 6500K
- Driver**
incluso
- Material**
aluminum + PC
- Colour**
satin white
satin black
- Selectable color temperature**
3000K / 4000K / 6500K
- Driver**
included

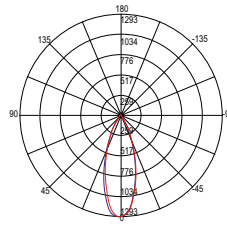

INC-DOT-R5

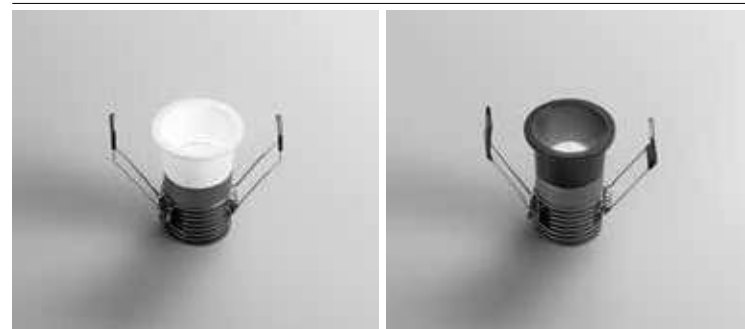

INC-DOT-R5-BCO 8031414893584	colour temp.	480 lm
INC-DOT-R5-NER 8031414893614	colour	480 lm
watt	5W	
beam angle	24°	
	Ø 37 mm	

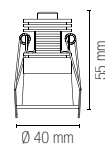

DAMA

Faretto da incasso con struttura in policarbonato e doppia ghiera intercambiabile rotonda e quadrata. Disponibile in bianco o nero.

Recessed light with polycarbonate structure and double interchangeable ring round or square. Available in black or white colors.

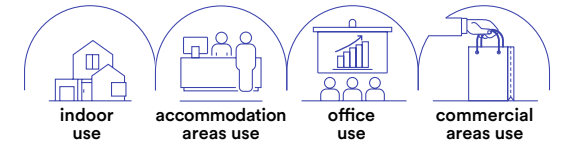

- Materiale**
PC
- Colore**
bianco
nero
- Temperatura colore**
4000K
- Driver**
incluso
- Material**
PC
- Colour**
white
black
- Colour temperature**
4000K
- Driver**
included

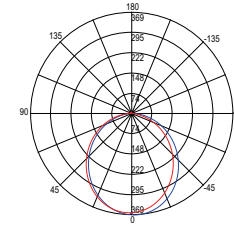

INC-DAMA-QR44



- Accessori inclusi / Included accessories**
- Cavo 30 cm / 30 cm cable
 - Ghiera intercambiabili / Interchangeable ring



INC-DAMA-QR44-BCO 8031414881581	colour temp.	300 lm
INC-DAMA-QR44-NER 8031414881598	colour	300 lm
watt	LED 3W	
beam angle	100°	
	Ø 35 mm	

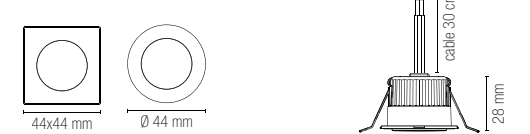

HYDE

Faretto da incasso con struttura in alluminio disponibile in bianco nero.

Recessed spotlight with aluminum structure available in black or white.

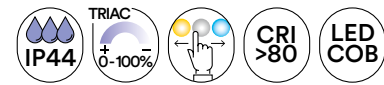
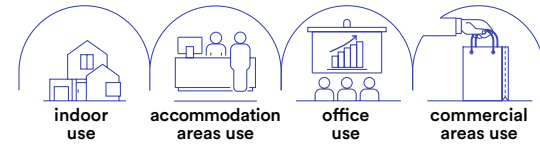

technical information **HYDE**



- Materiale**
alluminio + PC
- Colore**
bianco satinato
nero satinato
- Temperatura colore selezionabile**
2700K / 3200K / 4000K / 6500K
- Driver**
incluso
- Material**
aluminum + PC
- Colour**
satin white
satin black
- Selectable color temperature**
2700K / 3200K / 4000K / 6500K
- Driver**
included



INC-HYDE-BCO
8031414893560
lumen 750 lm

watt 8W
beam angle 60°
Ø 70 mm

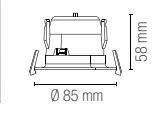

INC-HYDE-NER
8031414893577
lumen 750 lm

watt 8W
beam angle 60°
Ø 70 mm

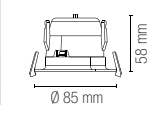

Fotometria del prodotto / Photometric curve

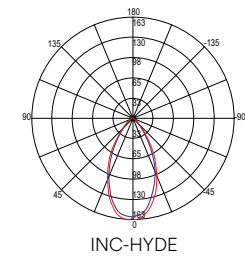

SINKRO

Faretto da incasso lineare antiriflesso con struttura in alluminio pressofuso, finitura con bordo bianco e interno nero lucido.

Anti-glare linear recessed spotlight with die-cast aluminum structure, finish with white border and glossy black interior.

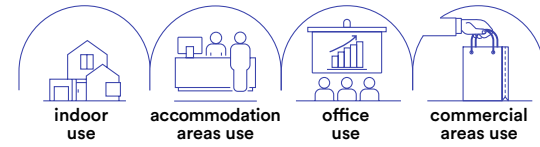

technical information **SINKRO**



Materiale
alluminio pressofuso

Colore
bordo bianco e
interno nero lucido



Temperatura colore
4000K



Driver
incluso

Material
die cast aluminum

Colour
white and glossy
black inside



Colour temperature
4000K



Driver
included

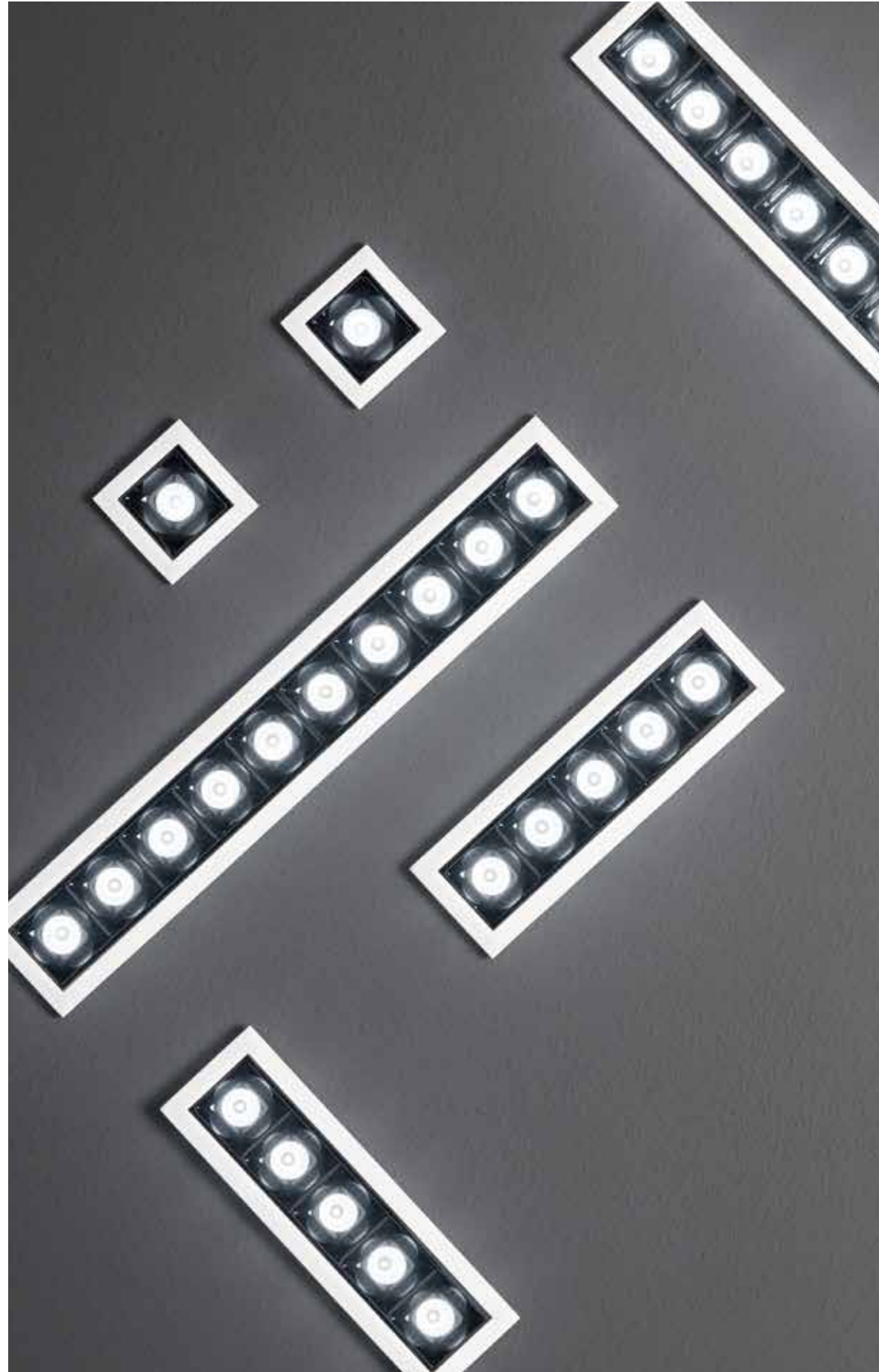

INC-SINKRO-2M
8031440360876
lumen

colour temp.	colour
230 lm	

watt	2W
beam angle	45°
	34 × 34 mm

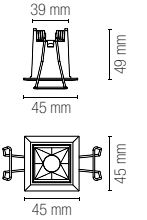

INC-SINKRO-10M
8031440360890
lumen

colour temp.	colour
1130 lm	

watt	5 × 2W
beam angle	45°
	136 × 34 mm

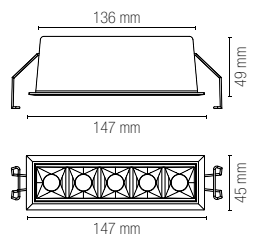

INC-SINKRO-20M
8031440360906
lumen

colour temp.	colour
2260 lm	

watt	10 × 2W
beam angle	45°
	269 × 34 mm

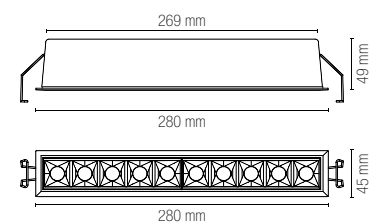

Fotometria del prodotto / Photometric curve

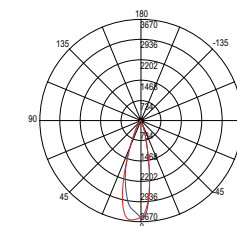

INC-SINKRO-2M

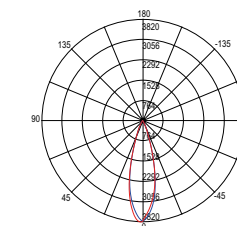

INC-SINKRO-10M

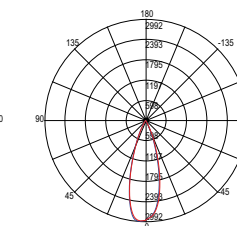

INC-SINKRO-20M

ELITE

Faretto da incasso antiriflesso con struttura in alluminio e finitura in bianco gofrato. Luce spot orientabile.

Anti-glare recessed spotlight with aluminum frame and embossed white finish. Adjustable spot light.

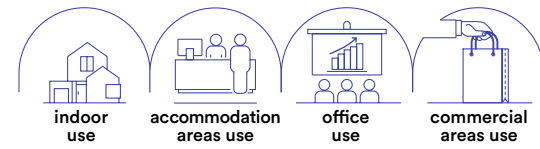

technical information **ELITE**



Materiale
alluminio

Colore
bianco
gofrato

Temperatura colore
3000K / 4000K



Driver
incluso

Material
aluminum

Colour
Embossed
white

Colour temperature
3000K / 4000K



Driver
included



	colour temp.	colour
INC-ELITE-1X10C 8031440363396 lumen		
	1000 lm	
INC-ELITE-1X10M 8031440363365 lumen		
	1000 lm	
watt	10W	
beam angle	40°	
pf	-	
	Ø 95 mm	

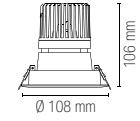

	colour temp.	colour
INC-ELITE-1X20C 8031440363372 lumen		
	2000 lm	
INC-ELITE-1X20M 8031440363341 lumen		
	2000 lm	
watt	20W	
beam angle	40°	
pf	-	
	Ø 107 mm	

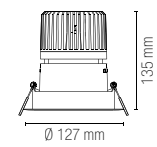

	colour temp.	colour
INC-ELITE-1X30C 8031440363358 lumen		
	2900 lm	
INC-ELITE-1X30M 8031440363327 lumen		
	2900 lm	
watt	30W	
beam angle	40°	
pf	0.90	
	Ø 150 mm	

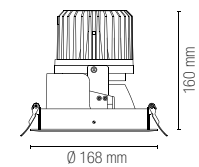

	colour temp.	colour
INC-ELITE-1X45C 8031440363334 lumen		
	4500 lm	
INC-ELITE-1X45M 8031440363303 lumen		
	4500 lm	
watt	45W	
beam angle	40°	
pf	0.90	
	Ø 150 mm	

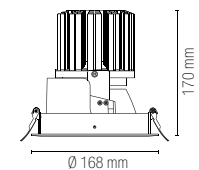

Fotometria del prodotto / Photometric curve

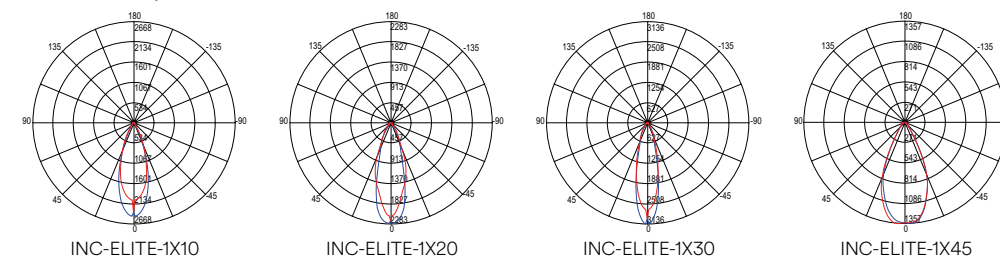

QUARK

Faretto da incasso con struttura in alluminio antiriflesso e finitura in bianco o nero satinato. Recessed spotlight with anti-reflective aluminum structure and satin black or white finish.

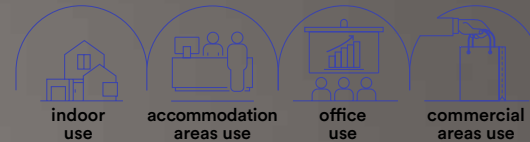

technical information **QUARK**



- Materiale**
alluminio + PC
- Colore**
bianco satinato
nero satinato
- Temperatura colore selezionabile**
3000K / 4000K / 6500K
- Driver**
incluso
- Material**
aluminum + PC
- Colour**
satin white
satin black
- Selectable color temperature**
3000K / 4000K / 6500K
- Driver**
included



	colour temp.	colour
INC-QUARK-R8-BCO 8031414893621 lumen	3000K / 4000K / 6500K	white / black
INC-QUARK-R8-NER 8031414893652 lumen	3000K / 4000K / 6500K	white / black
watt		8W
beam angle		38°
		Ø 50 mm

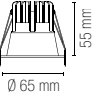

	colour temp.	colour
INC-QUARK-R12-BCO 8031414893638 lumen	3000K / 4000K / 6500K	white / black
INC-QUARK-R12-NER 8031414893669 lumen	3000K / 4000K / 6500K	white / black
watt		12W
beam angle		38°
		Ø 75 mm

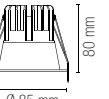

	colour temp.	colour
INC-QUARK-R18-BCO 8031414893645 lumen	3000K / 4000K / 6500K	white / black
INC-QUARK-R18-NER 8031414893676 lumen	3000K / 4000K / 6500K	white / black
watt		18W
beam angle		38°
		Ø 80 mm

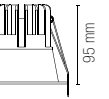

Fotometria del prodotto / Photometric curve

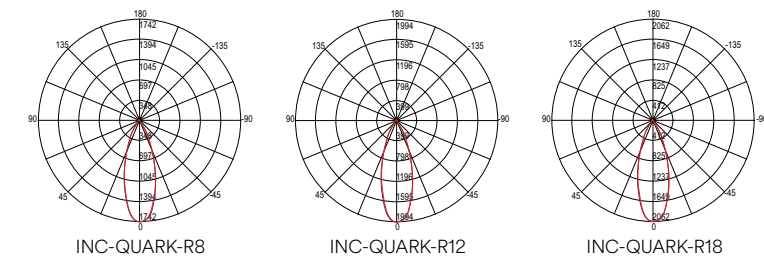

XANTO

Faretto da incasso con struttura in alluminio pressofuso antiriflesso con finitura in bianco satinato. Disponibile dalla forma quadrata o rotonda in diverse misure.

Recessed spotlight with anti-glare die-cast aluminum structure with satin white finish. Available in square or round shape different sizes.

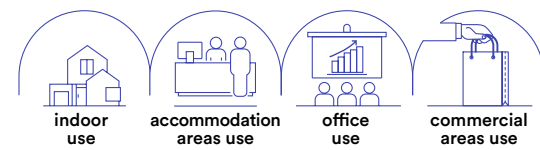

Materiale
alluminio pressofuso

Colore
bianco satinato

Temperatura colore
3000K / 4000K / 5000K



Driver
incluso

Material
die cast aluminum

Colour
satin white

Colour temperature
3000K / 4000K / 5000K



Driver
included



collection XANTO





	colour temp.	colour
INC-XANTO-C-R120 8031414861101 lumen	3000 K	White
INC-XANTO-M-R120 8031414861224 lumen	3000 K	White
INC-XANTO-F-R120 8031414861163 lumen	3000 K	White
watt	12W	
beam angle	98°	
pf	-	
	Ø 110 mm	

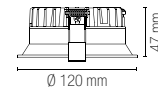

	colour temp.	colour
INC-XANTO-C-Q110 8031414861071 lumen	3000 K	White
INC-XANTO-M-Q110 8031414861194 lumen	3000 K	White
INC-XANTO-F-Q110 8031414861132 lumen	3000 K	White
watt	12W	
beam angle	98°	
pf	-	
	100 × 100 mm	

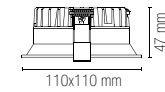

	colour temp.	colour
INC-XANTO-C-R154 8031414861118 lumen	3000 K	White
INC-XANTO-M-R154 8031414861231 lumen	3000 K	White
INC-XANTO-F-R154 8031414861170 lumen	3000 K	White
watt	18W	
beam angle	98°	
pf	-	
	Ø 145 mm	

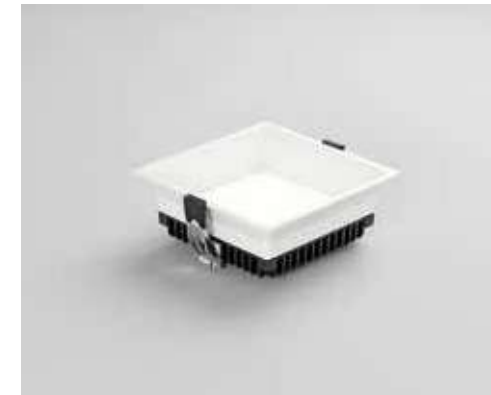
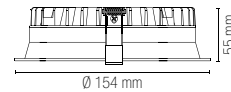

	colour temp.	colour
INC-XANTO-C-Q145 8031414861088 lumen	3000 K	White
INC-XANTO-M-Q145 8031414861200 lumen	3000 K	White
INC-XANTO-F-Q145 8031414861149 lumen	3000 K	White
watt	18W	
beam angle	98°	
pf	-	
	136 × 136 mm	

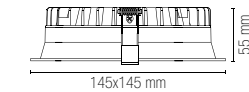

	colour temp.	colour
INC-XANTO-C-R220 8031414861125 lumen	3000 K	White
INC-XANTO-M-R220 8031414861248 lumen	3000 K	White
INC-XANTO-F-R220 8031414861187 lumen	3000 K	White
watt	30W	
beam angle	98°	
pf	0.90	
	Ø 200 mm	

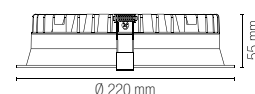

	colour temp.	colour
INC-XANTO-C-Q220 8031414861095 lumen	3000 K	White
INC-XANTO-M-Q220 8031414861217 lumen	3000 K	White
INC-XANTO-F-Q220 8031414861156 lumen	3000 K	White
watt	30W	
beam angle	98°	
pf	0.90	
	200 × 200 mm	

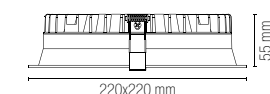

Fotometria del prodotto / Photometric curve

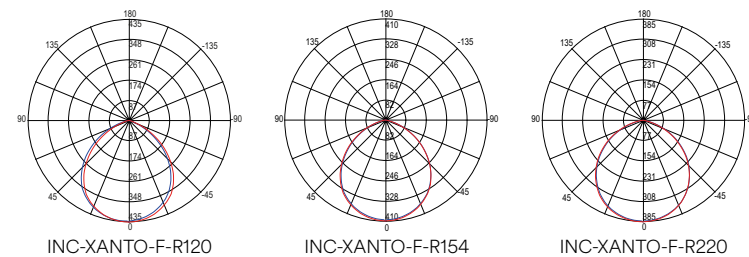

Fotometria del prodotto / Photometric curve

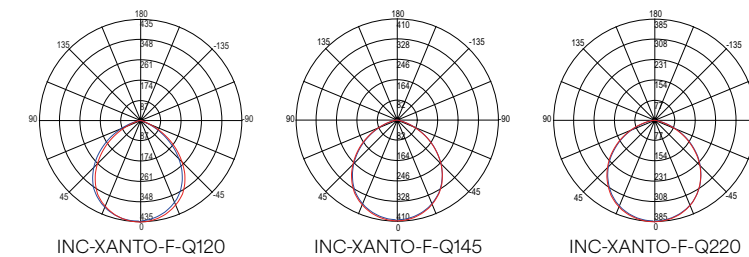

XANTO-INT

Faretto da incasso con struttura in alluminio pressofuso con funzione smart Wi-Fi, RF2.4G compatibili con dispositivi VOICE CONTROL.

Diecast aluminum downlight with smart Wi-Fi function, RF2.4G compatible with VOICE CONTROL devices.

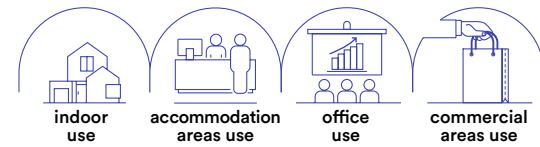

technical information XANTO-INT



Materiale
alluminio pressofuso

Colore
bianco satinato

Temperatura colore
RGB + CCT



Driver
incluso

Material
die cast aluminum

Colour
satin white

Colour temperature
RGB + CCT



Driver
included



INC-XANTO-R120-INT

8031414872695
lumen

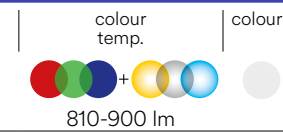

810-900 lm

watt 12W
beam angle 98°
pf -
Ø 110 mm

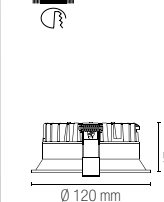

INC-XANTO-R220-INT

8031414868643
lumen

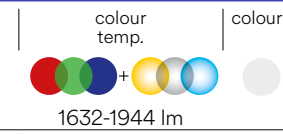

1632-1944 lm

watt 30W
beam angle 98°
pf 0.90
Ø 200 mm

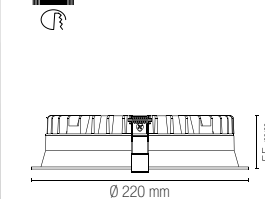

Accessorio non incluso / Not included accessory

RADIOCOMANDO-RF
8031414872725

Radiocomando RF 2.4G
controllo gruppi /
RF 2.4G remote control
control groups

Fotometria del prodotto / Photometric curve

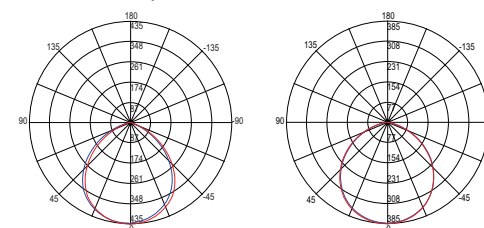

INC-XANTO-R120-INT

INC-XANTO-R220-INT

Control system easy installation

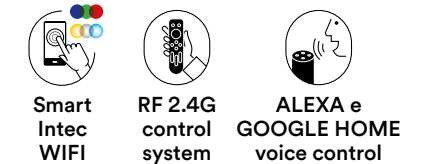

MACK

Faretto da incasso in policarbonato anti
abbagliamento con diffusore bianco e riflettore cromato.

Recessed spotlight in anti-glare polycarbonate
with white diffuser and chromed reflector.

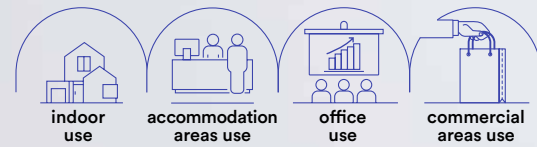

technical information **MACK**



Materiale
PC

Colore
bianco con
riflettore cromato



Temperatura colore
3000K / 4000K



Driver
integrato

Material
PC

Colour
white with
chrome reflector



Colour temperature
3000K / 4000K



Driver
built-in



INC-MACK-15C
8031414873913
lumen

colour temp.	colour
1650 lm	

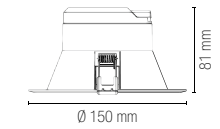

INC-MACK-15
8031414867974
lumen

colour temp.	colour
1650 lm	

watt 15W
beam angle 75°
 Ø 125 mm



INC-MACK-20C
8031414873906
lumen

colour temp.	colour
2500 lm	

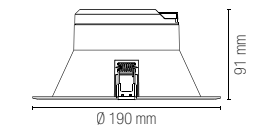

INC-MACK-20
8031414867981
lumen

colour temp.	colour
2500 lm	

watt 20W
beam angle 75°
 Ø 160 mm



INC-MACK-25C
8031414873890
lumen

colour temp.	colour
3050 lm	

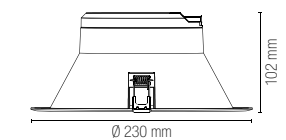

INC-MACK-25
8031414867998
lumen

colour temp.	colour
3050 lm	

watt 25W
beam angle 75°
 Ø 200 mm

Fotometria del prodotto / Photometric curve

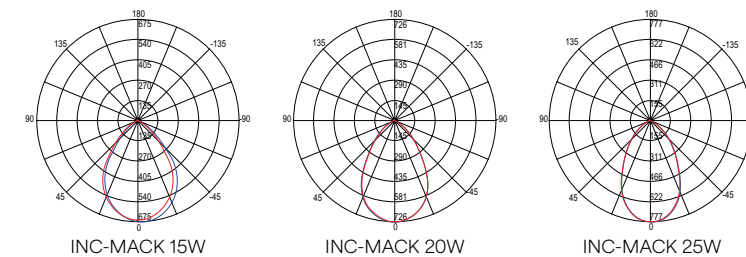

TRON

Faretto da incasso con struttura in alluminio e diffusore in acrilico bianco opaco con interruttore per regolazione temperatura colore.

Recessed spotlight with aluminum structure and matt white acrylic diffuser with switch for color temperature regulation.

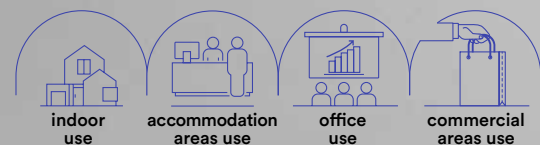

Materiale

struttura in alluminio,
diffusore in acrilico

Colore

bianco opaco



Temperatura colore selezionabile

3000K / 4000K / 6000K



Driver

incluso

Material

aluminum structure,
acrylic diffuser

Colour

matt white



Selectable color temperature

3000K / 4000K / 6000K



Driver

included



technical information **TRON**



INC-TRON-7
8031414876198
lumen

colour temp.	colour
720 lm	

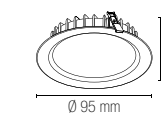

watt	7W
beam angle	120°
pf	-
	Ø 75 mm



INC-TRON-20
8031414876204
lumen

colour temp.	colour
2480 lm	

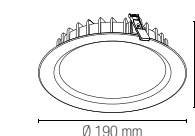

watt	20W
beam angle	120°
pf	0.90
	Ø 175 mm



INC-TRON-30
8031414876211
lumen

colour temp.	colour
3300 lm	

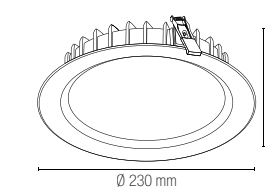

watt	30W
beam angle	120°
pf	0.90
	Ø 210 mm

Fotometria del prodotto / Photometric curve

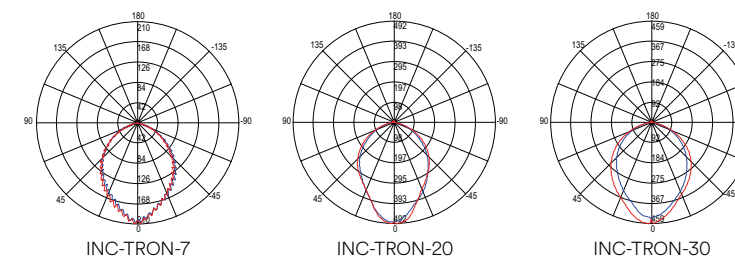

BLINK-EYES

Faretto da incasso in polycarbonato colore bianco opaco e funzione smart bluetooth per selezione temperatura colore.

Recessed spotlight in matt white polycarbonate and smart bluetooth function for selection and colour tempering.

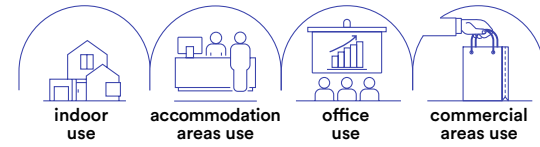

technical information **BLINK-EYES**



Materiale
polycarbonato

Colore
bianco opaco

Temperatura colore
RGB + CCT



CCT



Driver
integrato

Material
polycarbonate

Colour
matt white

Colour temperature
RGB + CCT



CCT



Driver
built-in



	colour temp.	colour
INC-EYES-BT 8031414877881 lumen	700-740-750 lm	
INC-BLINK-BT 8031414877911 lumen	700-740-750 lm	
watt	9W	
beam angle	96°	
	Ø 90 mm	

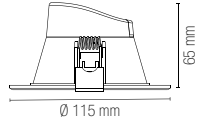

Fotometria del prodotto / Photometric curve

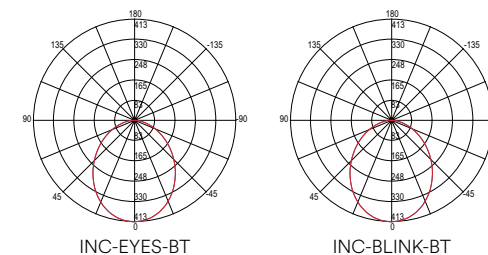

Control system easy installation



SLIM-INT

Faretto da incasso in alluminio pressofuso e diffusore in acrilico bianco satinato. Dotato di funzione smart Wi-Fi, RF2,4G compatibili con dispositivi VOICE CONTROL. Recessed spotlight in die-cast aluminum and diffuser in satin white acrylic. Equipped with smart Wi-Fi function, RF2,4G compatible with VOICE CONTROL devices.

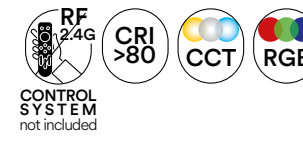
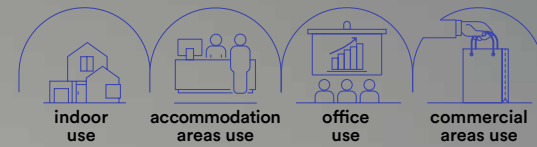

technical information **SLIM-INT**



INC-SLIM/6W-INT
8031414872701
lumen

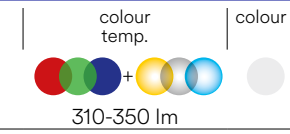

310-350 lm

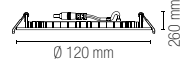

watt 6W
beam angle 120°
Ø 105 mm



INC-SLIM/18W-INT
8031414868612
lumen

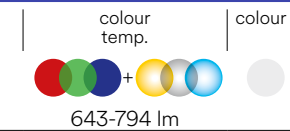

643-794 lm

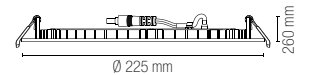

watt 18W
beam angle 120°
Ø 210 mm

Accessorio non incluso / Not included accessory



RADIOCOMANDO-RF
8031414872725

Radiocomando RF 2.4G
controllo gruppi /
RF 2.4G remote control
control groups

Materiale
alluminio pressofuso

Colore
struttura in alluminio,
diffusore in acrilico

Temperatura colore
RGB + CCT

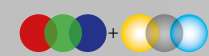

Driver
incluso

Material
die cast aluminum

Colour
aluminum structure,
acrylic diffuser

Colour temperature
RGB + CCT



Driver
included

Fotometria del prodotto / Photometric curve

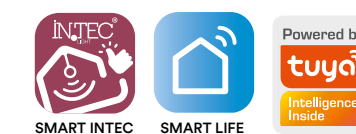
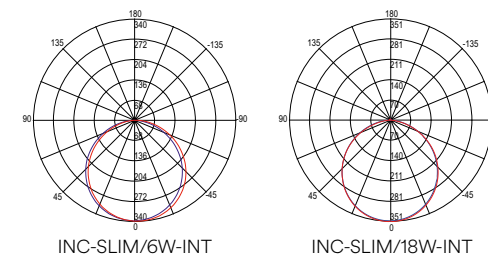

Control system easy installation

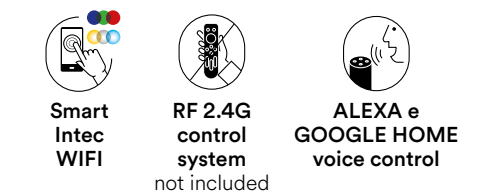

SLIM

Faretto da incasso con struttura rotonda in alluminio pressofuso ultrasottile.

Recessed spotlight with round structure in ultra-thin die-cast aluminum.



technical information **SLIM**



Materiale

alluminio pressofuso

Colore

bianco, nikel



Temperatura colore

3000K / 4000K / 6500K



Driver

incluso

Material

Die cast aluminum

Colour

white, nikel



Colour temperature

3000K / 4000K / 6500K



Driver

included



	colour temp.	colour
INC-SLIM/8WC BCO 8031440357180	☀	●
lumen	780 lm	
INC-SLIM/8W BCO 8031440357203	●	●
lumen	780 lm	
INC-SLIM/8WF BCO 8031440357197	☀	●
lumen	780 lm	

watt 8W
beam angle 120°
Ø 110 mm

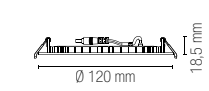

Fotometria del prodotto / Photometric curve

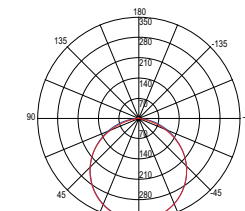

INC-SLIM/8W



	colour temp.	colour
INC-SLIM/12WC BCO 8031440357258	☀	●
lumen	1260 lm	
INC-SLIM/12W BCO 8031431491183	●	●
lumen	1260 lm	
INC-SLIM/12WF BCO 8031440357234	☀	●
lumen	1260 lm	
INC-SLIM/12W NIK 8031431501189	●	●
lumen	1260 lm	

watt 12W
beam angle 120°
Ø 156 mm

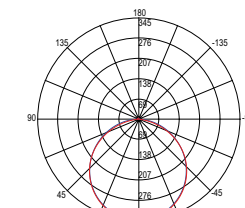
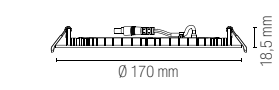

INC-SLIM/12W



	colour temp.	colour
INC-SLIM/18WC BCO 8031440357227	☀	●
lumen	1980 lm	
INC-SLIM/18W BCO 8031431511188	●	●
lumen	1980 lm	
INC-SLIM/18WF BCO 8031440357210	☀	●
lumen	1980 lm	
INC-SLIM/18W NIK 8031431521187	●	●
lumen	1980 lm	

watt 18W
beam angle 120°
Ø 205 mm

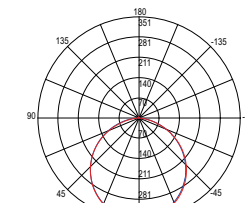
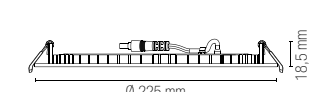

INC-SLIM/18W



	colour temp.	colour
INC-SLIM/24WC BCO 8031440364706	☀	●
lumen	2700 lm	
INC-SLIM/24W BCO 8031440364720	●	●
lumen	2700 lm	
INC-SLIM/24WF BCO 8031440364713	☀	●
lumen	2700 lm	
INC-SLIM/24W NIK 8031440364775	●	●
lumen	2700 lm	

watt 24W
beam angle 120°
Ø 220 mm

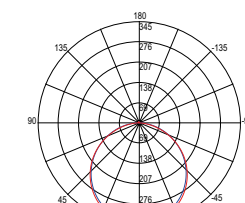
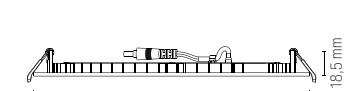

INC-SLIM/24W

SLIM CCT

Faretto da incasso con struttura rotonda in alluminio pressofuso ultrasottile con interruttore per regolazione temperatura colore.
Recessed spotlight with round structure in ultra-thin die-cast aluminum with switch for color temperature regulation.



Materiale
alluminio pressofuso

Colore
bianco

Temperatura colore selezionabile
3000K / 4000K / 6500K



Driver
incluso

Material
die cast aluminum

Colour
white

Selectable color temperature
3000K / 4000K / 6500K



Driver
included

INC-SLIM-8CCT
8031414892310
lumen 780 lm

colour temp. | colour
● ● ● ●

watt 8W
beam angle 120°
Ø 110 mm

INC-SLIM-12CCT
8031414892280
lumen 1260 lm

colour temp. | colour
● ● ● ●

watt 12W
beam angle 120°
Ø 160 mm

INC-SLIM-18CCT
8031414892297
lumen 1980 lm

colour temp. | colour
● ● ● ●

watt 18W
beam angle 120°
Ø 205 mm

INC-SLIM-24CCT
8031414892303
lumen 2700 lm

colour temp. | colour
● ● ● ●

watt 24W
beam angle 120°
Ø 220 mm

Fotometria del prodotto / Photometric curve

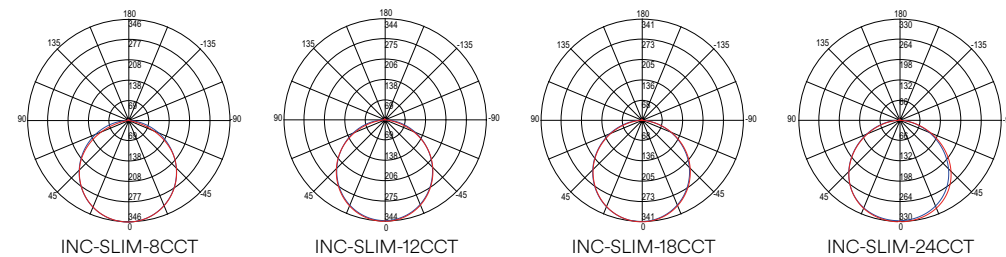

FLAP CCT

Faretto da incasso con struttura quadrata in alluminio pressofuso ultrasottile con interruttore per regolazione temperatura colore.
Recessed spotlight with square structure in ultra-thin die-cast aluminum with switch for color temperature regulation.



Materiale
alluminio pressofuso

Colore
bianco

Temperatura colore selezionabile
3000K / 4000K / 6500K



Driver
incluso

Material
die cast aluminum

Colour
white

Selectable color temperature
3000K / 4000K / 6500K



Driver
included

INC-FLAP-8CCT
8031414892273
lumen 780 lm

colour temp. | colour
● ● ● ●

watt 8W
beam angle 120°
110 x 110 mm

INC-FLAP-12CCT
8031414892242
lumen 1260 lm

colour temp. | colour
● ● ● ●

watt 12W
beam angle 120°
160 x 160 mm

INC-FLAP-18CCT
8031414892259
lumen 1980 lm

colour temp. | colour
● ● ● ●

watt 18W
beam angle 120°
205 x 205 mm

INC-FLAP-24CCT
8031414892266
lumen 2700 lm

colour temp. | colour
● ● ● ●

watt 24W
beam angle 120°
220 x 220 mm

Fotometria del prodotto / Photometric curve

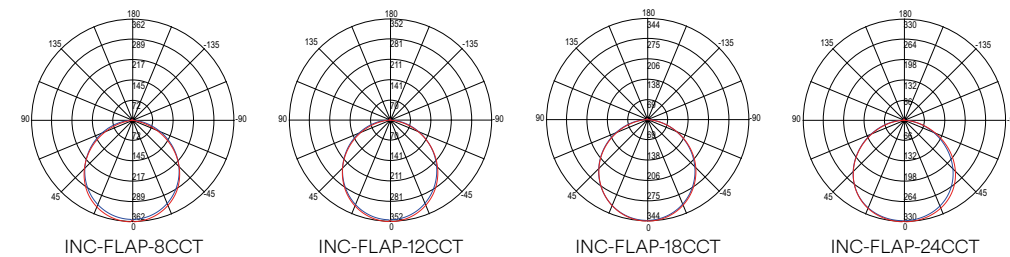

FLAP

Faretto da incasso con struttura quadrata in alluminio pressofuso ultrasottile.
Recessed spotlight with square structure in ultra-thin die-cast aluminum.

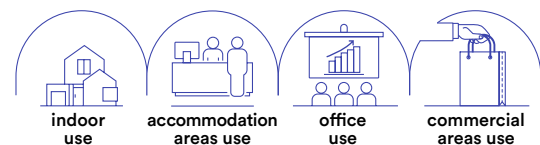

























technical information **FLAP**

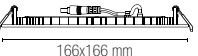













- Materiale**
alluminio pressofuso
- Colore**
bianco opaco
- Temperatura colore**
3000K / 4000K / 6500K
- Driver**
integrato
- Material**
die cast aluminum
- Colour**
satin white
- Colour temperature**
3000K / 4000K / 6500K
- Driver**
included



	INC-FLAP/8WC 8031440363419 lumen	colour temp.  	colour 	
		780 lm		
	INC-FLAP/8WM 8031440363402 lumen	 		
	INC-FLAP/8WF 8031440363389 lumen	 		
		780 lm		
watt		8W		
beam angle		120°		
		105 x 105 mm		

	INC-FLAP/12WC 8031440354615 lumen	colour temp.  	colour 	
		1260 lm		
	INC-FLAP/12W 8031431441188 lumen	 		
	INC-FLAP/12WF 8031440357265 lumen	 		
		1260 lm		
watt		12W		
beam angle		120°		
		155 x 155 mm		

	INC-FLAP/18WC 8031440357272 lumen	colour temp.  	colour 	
		1980 lm		
	INC-FLAP/18W 8031431451187 lumen	 		
	INC-FLAP/18WF 8031440357241 lumen	 		
		1980 lm		
watt		18W		
beam angle		120°		
		205 x 205 mm		

Fotometria del prodotto / Photometric curve

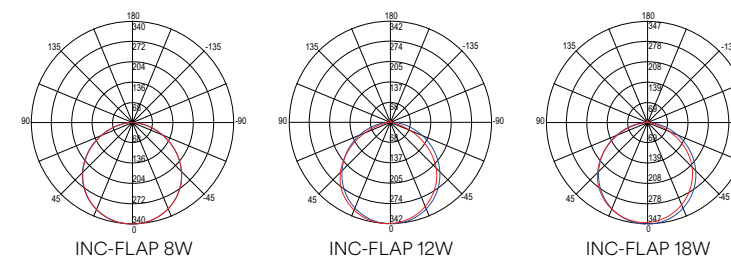

TOTAL

Incasso in alluminio con diffusore
in policarbonato effetto plafoniera
con bordi illuminati.
Built-in aluminum with polycarbonate
diffuser with illuminated edges.



technical information **TOTAL**



INC-TOTAL-R15
8031414893744
lumen

colour temp. | colour
1600 lm

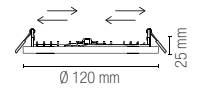

watt 15W
beam angle 120°
Ø 70 - 115 mm



INC-TOTAL-R24
8031414893751
lumen

colour temp. | colour
2680 lm

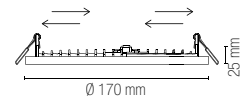

watt 24W
beam angle 120°
Ø 110 - 160 mm



INC-TOTAL-R30
8031414893768
lumen

colour temp. | colour
3280 lm

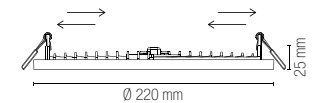

watt 30W
beam angle 120°
Ø 130 - 200 mm

Fotometria del prodotto / Photometric curve

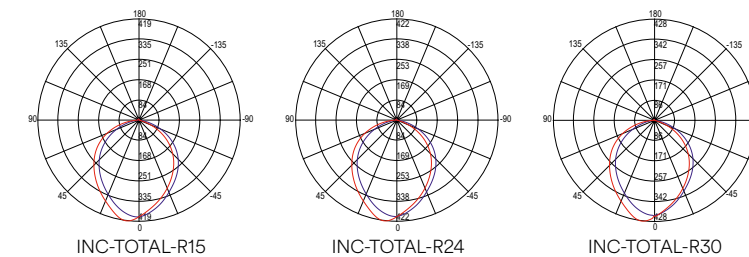

Materiale
alluminio + PC

Colore
bianco



**Temperatura colore
selezionabile**
3000K / 4000K / 6500K



Driver
incluso

Material
aluminum + PC

Colour
white



**Selectable color
temperature**
3000K / 4000K / 6500K



Driver
included

PLUS

Faretto da incasso con struttura in alluminio e diffusore in acrilico bianco opaco.

Recessed spotlight with aluminum frame and matt white acrylic diffuser.

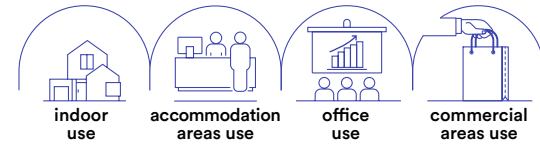

technical information **PLUS**



Materiale
struttura in alluminio
diffusore in acrilico

Colore
bianco opaco

Temperatura colore
4000K

Driver
incluso

Material
aluminum structure,
acrylic diffuser

Colour
satin white

Colour temperature
4000K

Driver
included



INC-PLUS-R8M
8031414876105
lumen

colour temp.	colour
●	●
780 lm	

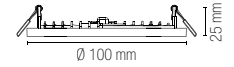

watt	8W
beam angle	120°
pf	-
	Ø 75 mm



INC-PLUS-R20M
8031414876136
lumen

colour temp.	colour
●	●
2220 lm	

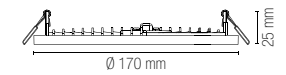

watt	20W
beam angle	120°
pf	-
	Ø 155 mm



INC-PLUS-R30M
8031414876167
lumen

colour temp.	colour
●	●
3420 lm	

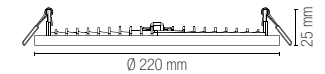

watt	30W
beam angle	120°
pf	0.90
	Ø 205 mm

Fotometria del prodotto / Photometric curve

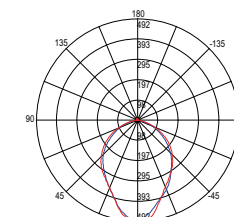

INC-PLUS-R8M

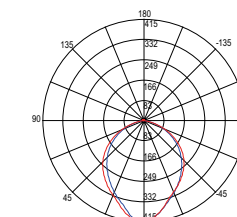

INC-PLUS-R20M

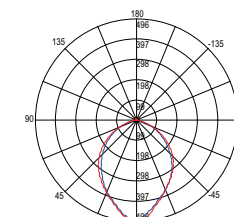

INC-PLUS-R30M

SNIPER

Faretto da incasso con struttura in fibre di plastica e punto luce orientabile.
Recessed spotlight with plastic fibre structure and adjustable light point.

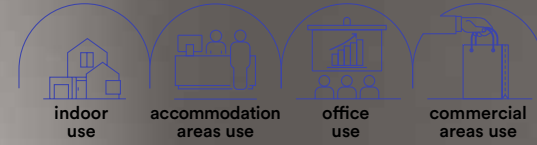

technical information **SNIPER**



Materiale
PC

Colore
bianco



Temperatura colore selezionabile
3000K / 4000K / 6500K



Driver
integrato

Material
PC

Colour
white



Selectable color temperature
3000K / 4000K / 6500K



Driver
built-in



INC-SNIPER-QR90
8031414888719
lumen

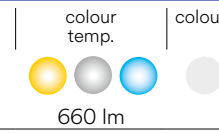

660 lm

watt **7W**
beam angle **38°**
Ø 70 mm

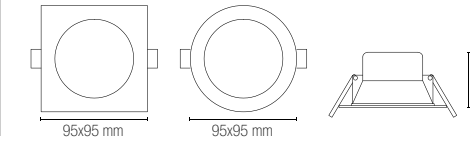

Accessori inclusi / Included accessories



due ghiera intercambiabili
1 rotonda 1 quadrata /
interchangeable ring



INC-SNIPER-QR120
8031414888726
lumen

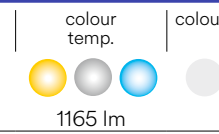

1165 lm

watt **12W**
beam angle **38°**
Ø 90 mm

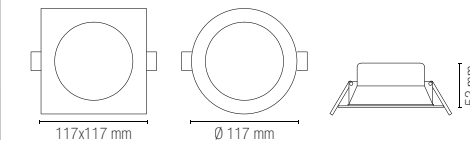

Accessori inclusi / Included accessories



due ghiera intercambiabili
1 rotonda 1 quadrata /
interchangeable ring

Fotometria del prodotto / Photometric curve

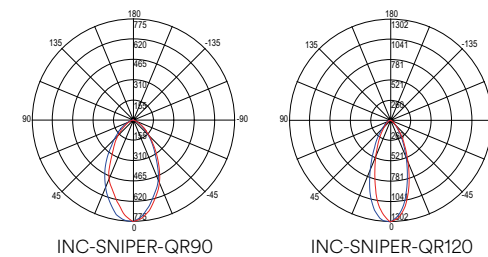

INC-SNIPER-QR90

INC-SNIPER-QR120

POLARIS

Faretto da incasso con struttura in alluminio e punto luce orientabile.
Recessed spotlight with aluminum structure and adjustable light point.

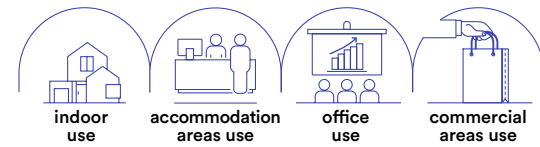

- Materiale**
alluminio
- Colore**
bianco goffrato
silver goffrato
- Temperatura colore**
4000K
- Driver**
incluso
- Durata e on/off**
25.000 h
>10.000 on/off
- Material**
aluminum
- Colour**
embossed white
embossed silver
- Colour temperature**
4000K
- Driver**
included

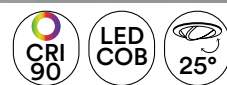

Life time and on/off
25.000 h
>10.000 on/off



INC-POLARIS-R3 BCO 8031429681169 lumen	colour temp. colour ● ●	300 lm	
INC-POLARIS-R3 8031432041196 lumen	● ●	300 lm	

INC-POLARIS R3
watt 3W
beam angle 24°
Ø 55 mm



INC-POLARIS-Q3 BCO 8031429761168 lumen	colour temp. colour ● ●	300 lm	
INC-POLARIS-Q3 8031432051195 lumen	● ●	300 lm	

INC-POLARIS Q3
watt 3W
beam angle 24°
Ø 55 mm

ORIONE

Faretto da incasso in alluminio nei colori bianco o silver goffrato.
Recessed aluminum spotlight in white or embossed silver.

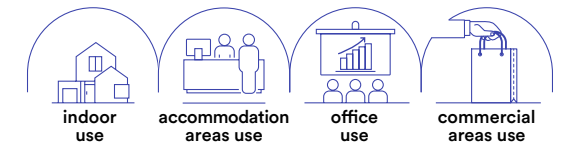

- Materiale**
alluminio
- Colore**
bianco goffrato
silver goffrato
- Temperatura colore**
4000K
- Driver**
incluso
- Material**
aluminum
- Colour**
embossed white
embossed silver
- Colour temperature**
4000K
- Driver**
included

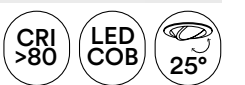

INC-ORIONE-R6 BCO 8031429771167 lumen	colour temp. colour ● ●	650 lm	
INC-ORIONE-R6 8031432021198 lumen	● ●	650 lm	

INC-ORIONE R6
watt 7W
beam angle 87°
Ø 75 mm



INC-ORIONE-Q6 BCO 8031434361216 lumen	colour temp. colour ● ●	650 lm	
INC-ORIONE-Q6 8031432031197 lumen	● ●	650 lm	

INC-ORIONE Q6
watt 7W
beam angle 87°
Ø 75 mm

FUSION

Faretto da incasso in alluminio con finitura in nikel, bianco satinato o oro.
Recessed aluminum spotlight with nikel, satin white or gold finish.

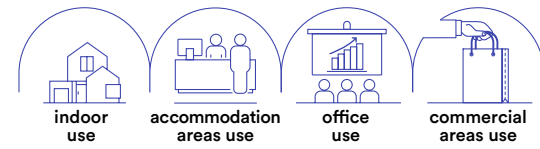

technical information **FUSION**



- Materiale**
alluminio
- Colore**
bianco satinato
nikel
oro
- Temperatura colore**
4000K
- Driver**
integrato
- Material**
aluminum
- Colour**
white
nikel
gold
- Colour temperature**
4000K
- Driver**
built-in



1 pz / 1 pcs



	colour temp.	colour
INC-FUSION-5W BCO 8031440361736 lumen	4000K	white
INC-FUSION-5W NIK 8031440361705 lumen	4000K	nikel
INC-FUSION-5W ORO 8031440361712 lumen	4000K	gold
watt	5W	
beam angle	120°	
	Ø 60 mm	

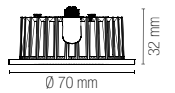

Kit 3 pz / Kit 3 pcs



	colour temp.	colour
INC-FUSION-3X5W BCO 8031440353335 lumen	4000K	white
INC-FUSION-3X5W NIK 8031440353342 lumen	4000K	nikel
INC-FUSION-3X5W ORO 8031440353359 lumen	4000K	gold
watt	3 × 5W	
beam angle	120°	
	Ø 60 mm	

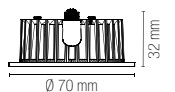

Fotometria del prodotto / Photometric curve

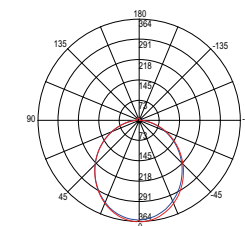

INC-FUSION 5W

Le curve fotometriche rappresentano il singolo modulo LED per ogni elemento / Above photometric curve represent the single module of each element

BLITZ

Lampada sottopensile kit 3pz con struttura in alluminio in policarbonato bianco opaco.
Cabinet ceiling lamp kit 3pz with aluminum structure in opal white polycarbonate.

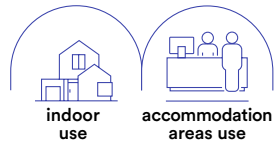

- Materiale**
struttura in alluminio
diffusore in pc
- Colore**
bianco opaco
- Temperatura colore**
4000K
- Driver**
incluso
- Material**
aluminum structure with PC diffuser
- Colour**
satin white and silver reflector
- Colour temperature**
4000K
- Driver**
included

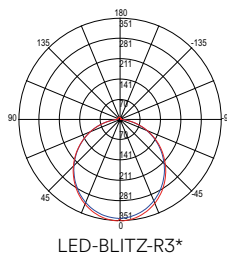

Le curve fotometriche rappresentano il singolo modulo LED per ogni elemento / Above photometric curve represent the single module of each element

Accessori inclusi / Included accessories



x3
Driver + morsettiera con cavo 1,5m / Driver + connector with 1,5m cable included

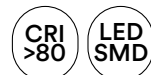

Kit 3 pz / Kit 3 pcs



LED-BLITZ-R3
8031440353274
lumen

colour temp.	colour
	350 lm

watt	3 x 5W
beam angle	105°

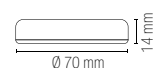

NEMO

Lampada sottopensile da incasso con struttura in termoplastica con finitura in bianco o silver.
Recessed cabinet lamp with thermoplastic structure with white or silver finish.

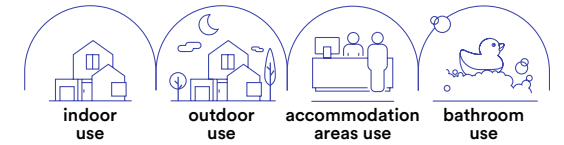

- Materiale**
struttura in termoplastica
- Colore**
bianco
silver
- Temperatura colore**
4000K
- Driver**
integrato
- Material**
thermoplastic structure
- Colour**
white
silver
- Colour temperature**
4000K
- Driver**
built-in

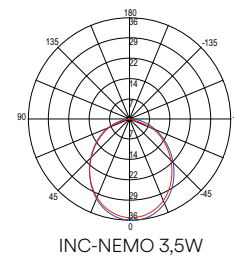

INC-NEMO-65 BCO
8031414877065
lumen

colour temp.	colour
	300 lm

INC-NEMO-65 SIL
8031414877072
lumen

colour temp.	colour
	300 lm

watt	3,5W
beam angle	120°
	Ø 55 mm

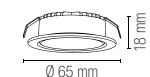

RAINBOW

Faretto da incasso in alluminio in bianco o cromato.
Recessed aluminum spotlight in white or chromed.

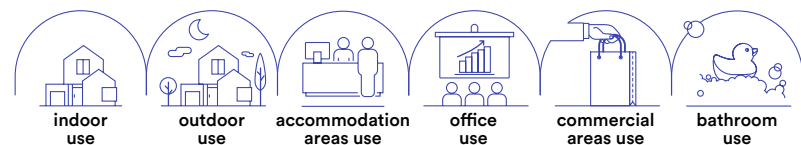

- Materiale**
alluminio
- Colore**
bianco
cromo
- Temperatura colore**
RGB + 4000K
- Driver**
DC 12V
tensione costante
non incluso
- Material**
aluminum
- Colour**
white
chrome
- Colour temperature**
RGB + 4000K
- Driver**
DC 12V
constant voltage
not included



EASY DOMOTICA



INC-RAINBOW-M BCO
8031414862627
lumen 110 lm

INC-RAINBOW-M
8031414862603
lumen 110 lm

colour temp.	colour

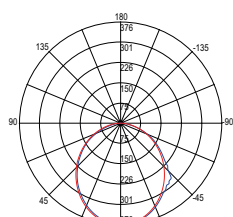

INC-RAINBOW 4000K
watt 5W
beam angle 120°
Ø 90 mm

Sistema di connessione / Connection system
Driver pag. 837-846
Controller pag. 848-851

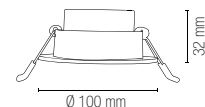
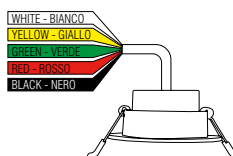

ZENIT

Faretto da incasso orientabile con struttura in policarbonato e finitura in nikel, bianco satinato, cromo o oro.
Adjustable recessed spotlight with polycarbonate structure and nikel, satin white, chrome or gold finish.

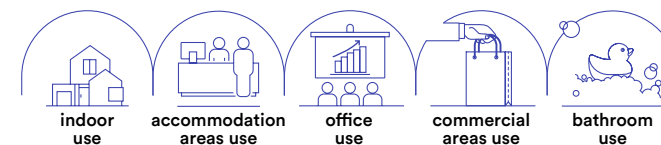

- Materiale**
policarbonato
- Colore**
bianco satinato
nikel
cromo
oro
- Temperatura colore**
3000K
- Driver**
integrato
- Material**
polycarbonate
- Colour**
satin white
nikel
chrome
gold finish
- Colour temperature**
3000K
- Driver**
built-in



INC-ZENIT-5W BCO
8031439881276
lumen 390 lm

INC-ZENIT-5W NIK
8031439901271
lumen 390 lm

INC-ZENIT-5W CR
8031439891275
lumen 390 lm

INC-ZENIT-5W ORO
8031439911270
lumen 390 lm

colour temp.	colour

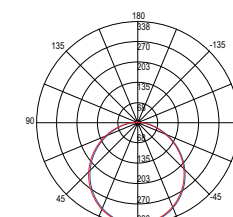

INC-ZENIT 5W
watt 5W
beam angle 120°
Ø 65 mm

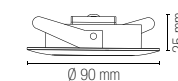

QUANTUM

Faretto da incasso con struttura in alluminio
nelle versioni bianco e nero satinato.
Recessed spotlight with aluminum structure
in white and satin black versions.

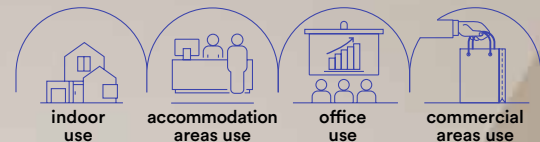

Materiale
alluminio + PC

Colore
bianco satinato
nero satinato



Temperatura colore selezionabile
3000K / 4000K / 6500K



Driver
integrato

Material
aluminum + PC

Colour
satin white
satin black



Selectable color temperature
3000K / 4000K / 6500K



Driver
built-in



technical information **QUANTUM**



	INC-QUANTUM-R18-BCO 8031414893683 lumen	colour temp. 2000 lm	colour white	
	INC-QUANTUM-R18-NER 8031414893713 lumen	colour temp. 2000 lm	colour black	
watt		18W		
beam angle		60°		
pf		-		
		Ø 120 mm		

	INC-QUANTUM-R30-BCO 8031414893690 lumen	colour temp. 3300 lm	colour white	
	INC-QUANTUM-R30-NER 8031414893720 lumen	colour temp. 3300 lm	colour black	
watt		30W		
beam angle		60°		
pf		0.90		
		Ø 140 mm		

	INC-QUANTUM-R40-BCO 8031414893706 lumen	colour temp. 4300 lm	colour white	
	INC-QUANTUM-R40-NER 8031414893737 lumen	colour temp. 4300 lm	colour black	
watt		40W		
beam angle		60°		
pf		0.90		
		Ø 165 mm		

Fotometria del prodotto / Photometric curve

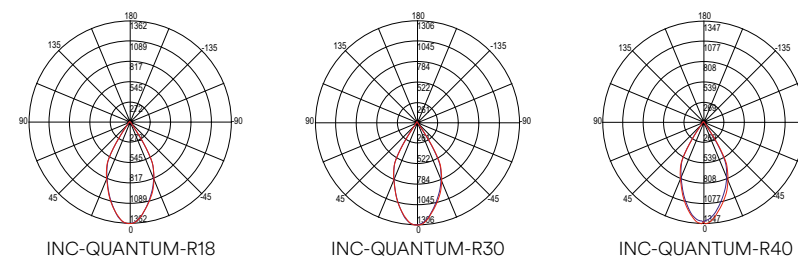

HORUS

Faretto da incasso dimmerabile con struttura in policarbonato bianco opaco.
Dimmable recessed spotlight with matt white polycarbonate structure.

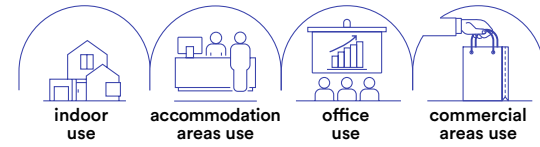

technical information **HORUS**





- Materiale**
policarbonato
- Colore**
bianco opaco
- Temperatura colore**
4000K
- Dimmer**
dimmer 1-10
- Driver**
integrato
- Material**
polycarbonate
- Colour**
matt white
- Colour temperature**
4000K
- Dimmer**
dimmable 1-10
- Driver**
built-in





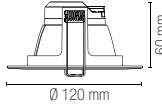

colour temp.	colour
1050 lm	
watt	10W
beam angle	100°
pf	-
	Ø 90 mm





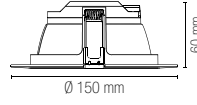

colour temp.	colour
1900 lm	
watt	15W
beam angle	100°
pf	-
	Ø 120 mm



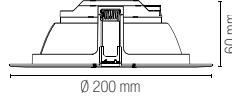

colour temp.	colour
2600 lm	
watt	20W
beam angle	100°
pf	-
	Ø 170 mm





colour temp.	colour
3250 lm	
watt	25W
beam angle	100°
pf	0.90
	Ø 200 mm

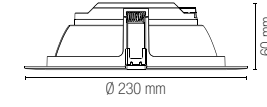

Fotometria del prodotto / Photometric curve

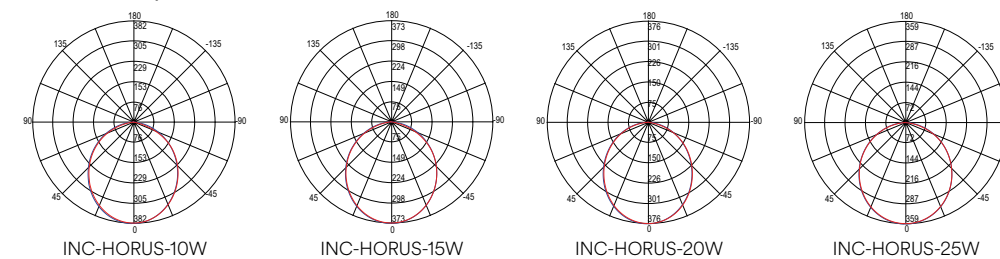

MATRIX

Faretto da incasso in metallo con lampadina GU10
inclusa disponibile nei colori bianco, nikel, oro e cromo.
Recessed metal spotlight with GU10 bulb included
available in white, nikel, gold and chrome.



Materiale
metallo

Colore
bianco
nikel
cromo
oro



Temperatura colore
3000K



Material
metal

Colour
white
nikel
chrome
gold



Colour temperature
3000K



collection **MATRIX**





Kit 3 pz / Kit 3 pcs

Ø 80 mm

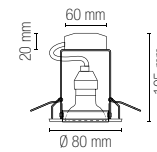

INC-MATRIX-LEDF3 BCO
8031440359320



INC-MATRIX-LEDF3 NIK
8031440359337



3 x GU10

5W LED
Ø 60 mm



**3 lampadine LED SMD /
3 LED SMD light bulbs**

watt	5W
beam angle	100°
cri	80
on/off	>10.000
3000K	
lumen	3 x 413 lm



**Staffa con connettore /
Bracket with connector**

3 pz inclusi / 3 pcs included



**GU10 230V~50Hz
Portalamпада /
Lampholder**

3 pz inclusi / 3 pcs included

Kit 3 pz / Kit 3 pcs

Ø 100 mm
orientabile / adjustable

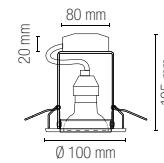

INC-MATRIX-LEDM3 BCO
8031429651162



INC-MATRIX-LEDM3 NIK
8031431571182



INC-MATRIX-LEDM3 CR
8031440313032



INC-MATRIX-LEDM3 ORO
8031440313025



3 x GU10

5W LED
Ø 80 mm



**3 lampadine LED SMD /
3 LED SMD light bulbs**

watt	5W
beam angle	100°
cri	80
on/off	>10.000
3000K	
lumen	3 x 413 lm



**Staffa con connettore /
Bracket with connector**

3 pz inclusi / 3 pcs included



**Portalamпада /
Lampholder
GU10 230V~50Hz**

3 pz inclusi / 3 pcs included



1 pz / 1 pcs

Ø 100 mm
orientabile / adjustable

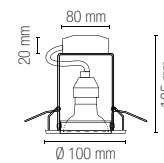

INC-MATRIX-LEDM1 BCO
8031440313063



INC-MATRIX-LEDM1 NIK
8031440313049



INC-MATRIX-LEDM1 CR
8031440313056



INC-MATRIX-LEDM1 ORO
8031440313070



1 x GU10

5W LED
Ø 80 mm



**Lampadina LED SMD /
LED SMD light bulb**

watt	5W
beam angle	100°
cri	80
on/off	>10.000
3000K	
lumen	413 lm



**Staffa con connettore /
Bracket with connector**

3 pz inclusi / 3 pcs included



**Portalamпада /
Lampholder
GU10 230V~50Hz**

3 pz inclusi / 3 pcs included



TUBEX

Incasso in gesso componibile da integrare nel cartongesso per dare omogeneità tra parete e corpo illuminante. Punto luce regolabile e orientabile con finitura in bianco o nero goffrato.
 Recessed paintable gypsum downlight to be integrated into the plasterboard to give homogeneity between the ceiling and the lighting body. Adjustable light point with embossed black or white finish.

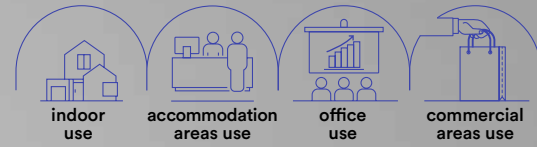

technical information **TUBEX**



INC-TUBEX-2C-BCO
 8031414883752
 lumen

colour temp.	colour
190 lm	



INC-TUBEX-2C-NER
 8031414883776
 lumen

colour temp.	colour
190 lm	



INC-TUBEX-BASE
 8031414883745

watt	2,5W
beam angle	30°
	165 x 165 mm

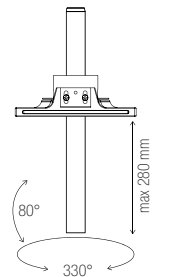
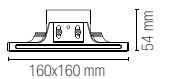
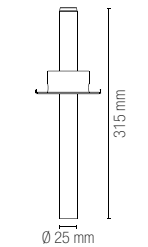

Modular system:
 INC-TUBEX-BASE
 + INC-TUBEX-2

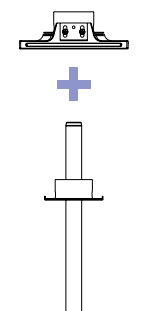

Staffa regolabile /
 Adjustable bracket

Materiale
 gesso e alluminio

Colore
 bianco goffrato
 nero goffrato



Temperatura colore
 3000K / 4000K



Driver
 incluso

Material
 gypsum and aluminum

Colour
 embossed white
 embossed black



Colour temperature
 3000K / 4000K



Driver
 included

STARRY

Incasso in gesso componibile da integrare nel cartongesso per dare omogeneità tra parte e corpo illuminante.

Recessed paintable gypsum downlight to be integrated into the plasterboard to give homogeneity between the ceiling and the lighting body.

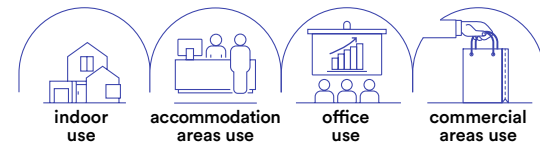

- Materiale**
gesso
alluminio
- Colore**
bianco
- Temperatura colore**
3000K / 4000K
- Driver**
incluso
- Material**
gypsum
aluminum
- Colour**
white
- Colour temperature**
3000K / 4000K
- Driver**
included

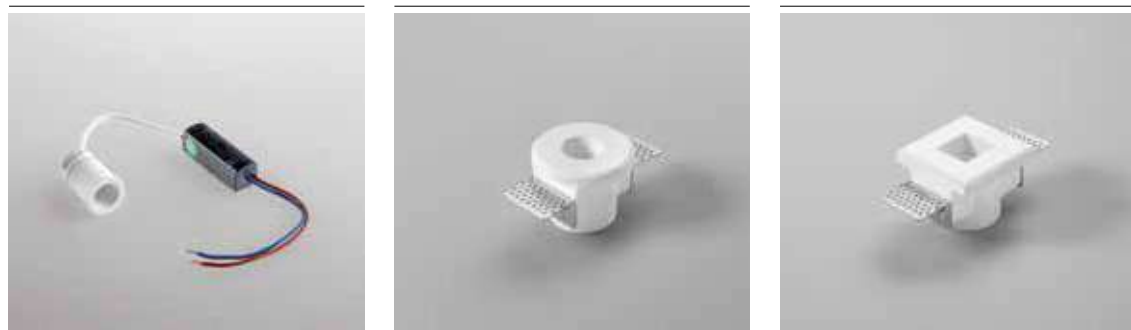
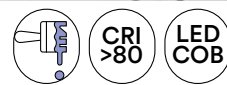

Modular system:
LED-STARRY +
INC-STARRY-R1

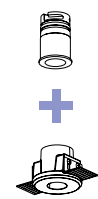

Modular system:
LED-STARRY +
INC-STARRY-Q1

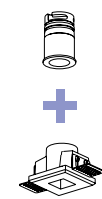

LED-STARRY-C 8031414884476	colour temp. 160 lm
LED-STARRY-M 8031414884483	160 lm
watt	2,5W
beam angle	45°



INC-STARRY-R1
8031414884452

Ø 75 mm

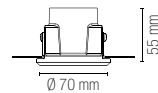

INC-STARRY-Q1
8031414884469

75 x 75 mm

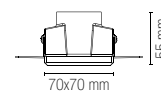

GHOST

Incasso in gesso verniciabile da integrare nel cartongesso per dare omogeneità tra parete e corpo illuminante.

Recessed paintable gypsum downlight to be integrated into the plasterboard to give homogeneity between the ceiling and the lighting body.

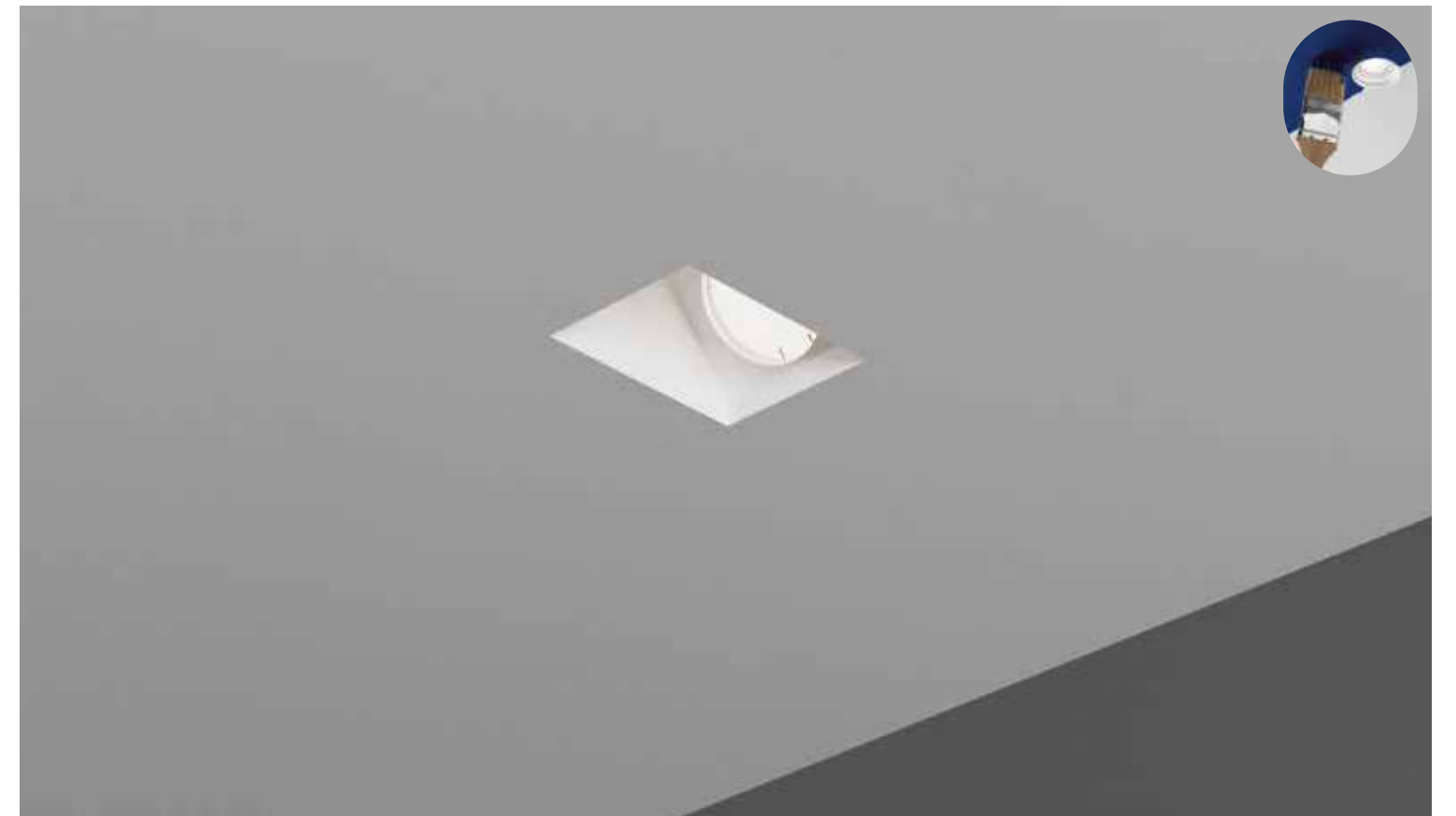
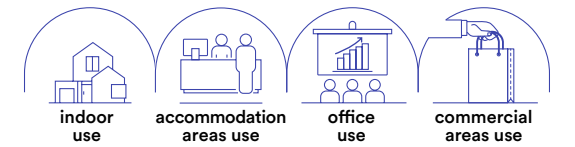

INC-GHOST-Q1D
8031434241211

1 x GU10 MAX 35W
125 x 125 mm

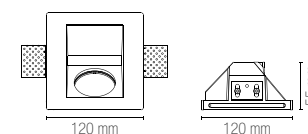

INC-GHOST-Q1
8031434261219

1 x GU10 MAX 35W
125 x 125 mm

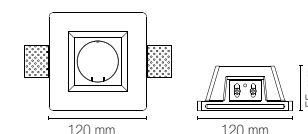

INC-GHOST-Q2
8031434301212

2 x GU10 MAX 35W
219 x 123 x 8-15 mm

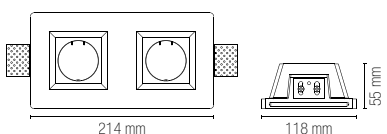

Staffa regolabile /
Adjustable bracket



Portalamпада incluso /
Lampholder included



Lampadina non inclusa /
Light bulb not included

VULKAN

Incasso in gesso verniciabili con cilindri intercambiabili e finiture bianco, nero e oro satinato.

Gypsum down light paintable with interchangeable cylinders and in white, black and satin gold finishes.

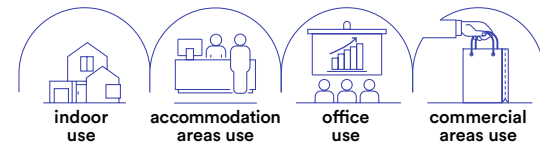

Modular system:
INC-VULKAN-BASE
+ INC-VULKAN

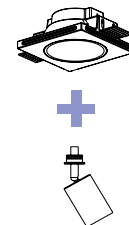

Staffa regolabile /
Adjustable bracket



Portalampada incluso /
Lampholder included



Lampadina non inclusa /
Light bulb not included

INC-VULKAN-BASE
8031414883707

1 x GU10 MAX 35W
170 x 170 mm

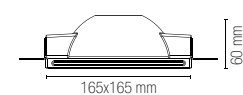

INC-VULKAN-BCO
8031414883714

INC-VULKAN-NER
8031414883721

INC-VULKAN-ORO
8031414883738
1 x GU10 MAX 35W

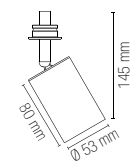

colour



ENTITY

Incasso in gesso verniciabile con ghiera intercambiabili in finiture bianco, oro e cromo.

Gypsum down light paintable with interchangeable cylinders white, black and satin gold finishes.

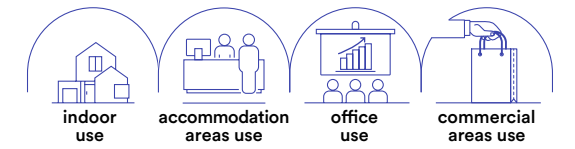

Modular system:
INC-ENTITY-Q
+ ENTITY-RING

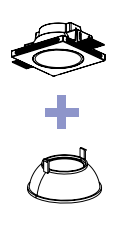

Staffa regolabile /
Adjustable bracket



Portalampada incluso /
Lampholder included



Lampadina non inclusa /
Light bulb not included

INC-ENTITY-Q
8031414883790

1 x GU10 MAX 35W
125 x 125 mm

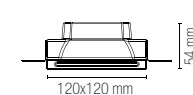

ENTITY-RING-CR
8031414883813

ENTITY-RING-NER
8031414883820

ENTITY-RING-ORO
8031414883806
1 x GU10 MAX 35W

colour

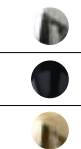

GOBLET

Incasso con struttura sporgente in gesso verniciabile e portalampane incluso.
Gypsum prominent down light paintable and lamp holder included.

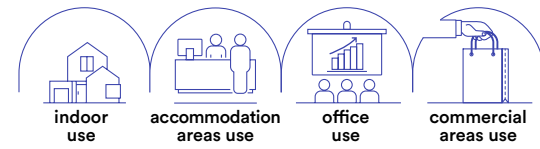

INC-GOBLET-R
8031414882960

1 x GU10 MAX 35W
Ø 75 mm



INC-GOBLET-Q
8031414882977

1 x GU10 MAX 35W
Ø 75 mm

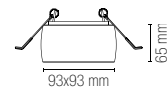
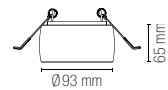

Portalampane incluso /
Lampholder included



Lampadina non inclusa /
Light bulb not included

SHADOW

Incasso con struttura in gesso verniciabile e portalampane incluso.
Gypsum downlight paintable and lamp holder included.

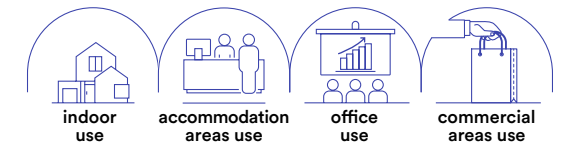

INC-SHADOW-R
8031414882984

1 x GU10 MAX 35W
Ø 90 mm



INC-SHADOW-Q
8031414882991

1 x GU10 MAX 35W
Ø 100 mm

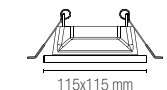
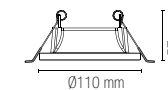

Portalampane incluso /
Lampholder included



Lampadina non inclusa /
Light bulb not included

PHANTOM

Incasso con struttura in gesso verniciabile e portalampane incluso.
Gypsum downlight paintable and lamp holder included.

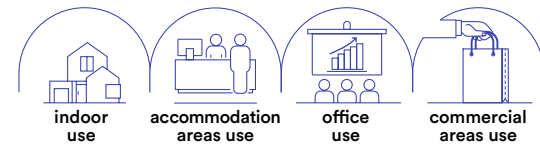

INC-PHANTOM-R1
8031431551184

1x GU10 MAX 35W
Ø 83 mm



INC-PHANTOM-Q1
8031431561183

1x GU10 MAX 35W
82 x 82 mm

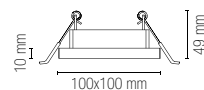
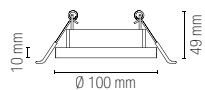

Portalampane incluso /
Lampholder included



Lampadina non inclusa /
Light bulb not included

SPETTRO

Incasso con struttura in gesso verniciabile e portalampane incluso.
Gypsum downlight paintable and lamp holder included.

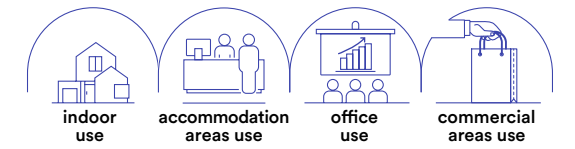

INC-SPETTRO-R1
8031431531186

1x GU10 MAX 35W
Ø 85 mm



INC-SPETTRO-Q1
8031431541185

1x GU10 MAX 35W
Ø 95 x 95 mm

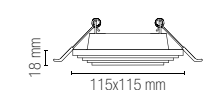
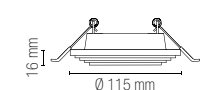

Portalampane incluso /
Lampholder included



Lampadina non inclusa /
Light bulb not included

MINI

Incasso in gesso da integrare nel cartongesso per dare omogeneità tra parete e corpo illuminante.

Recessed gypsum downlight to be integrated into te plasterboard to give homogeneity between the ceiling and the lighting body.

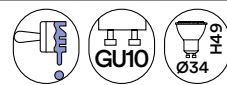
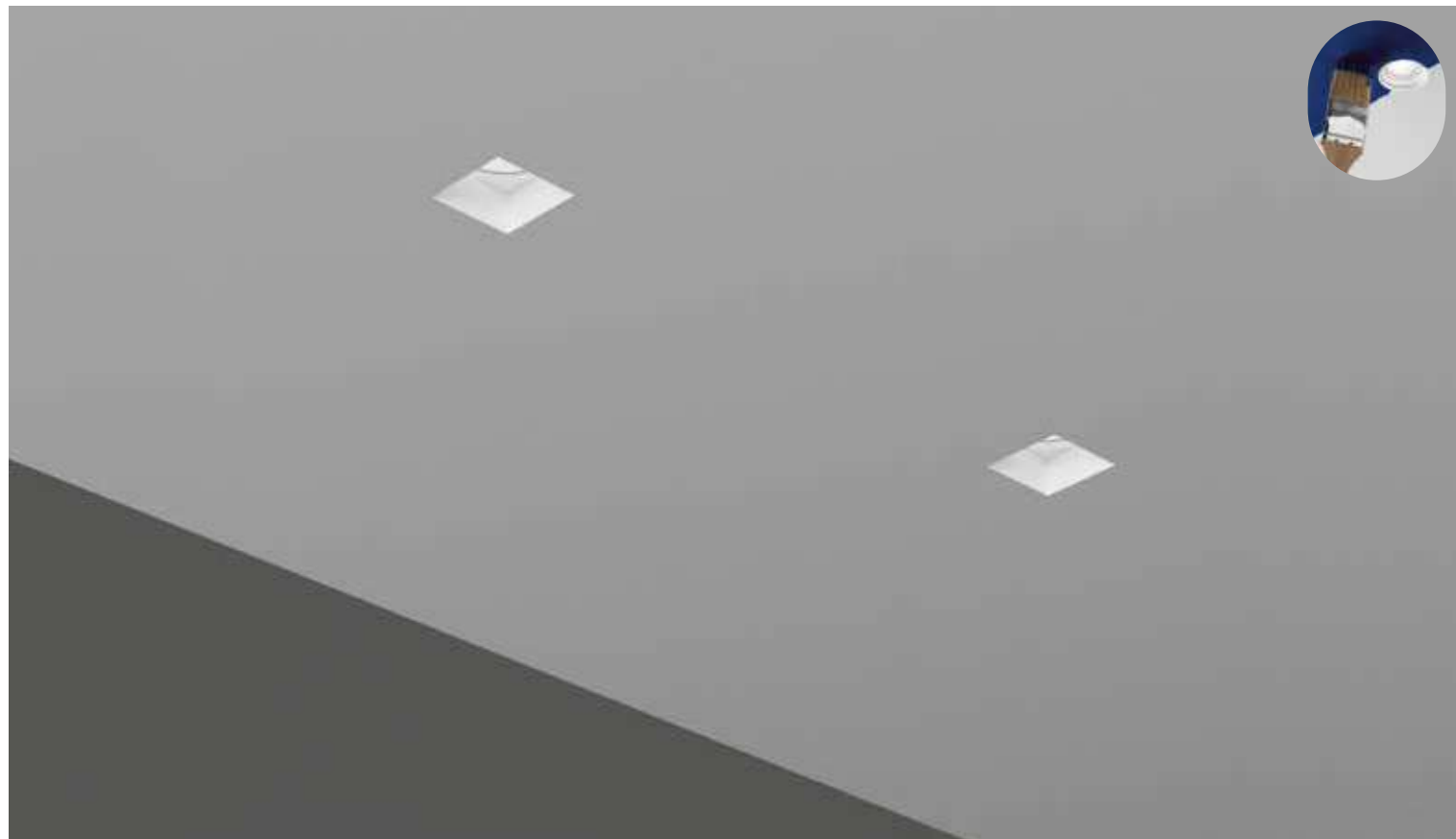
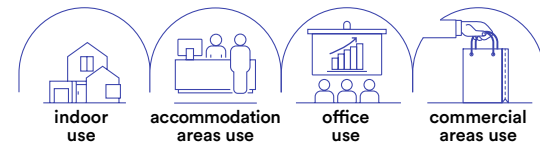

INC-MINI-R1
8031414873623

1 x MINI GU10 MAX 35W
bulb size \varnothing 34 mm
 \varnothing 73 mm

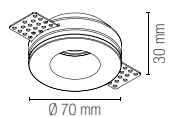

INC-MINI-Q1
8031414873616

1 x MINI GU10 MAX 35W
bulb size \varnothing 34 mm
73 x 73 mm

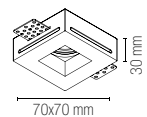

HIVE

Incasso in gesso verniciabile con 4 punti luce da integrare nel cartongesso per dare omogeneità tra soffitto e corpo illuminante.

Recessed gypsum paintable downlight with 4 light to be integrated into the plasterboard to give homogeneity between ceiling and lighting body.

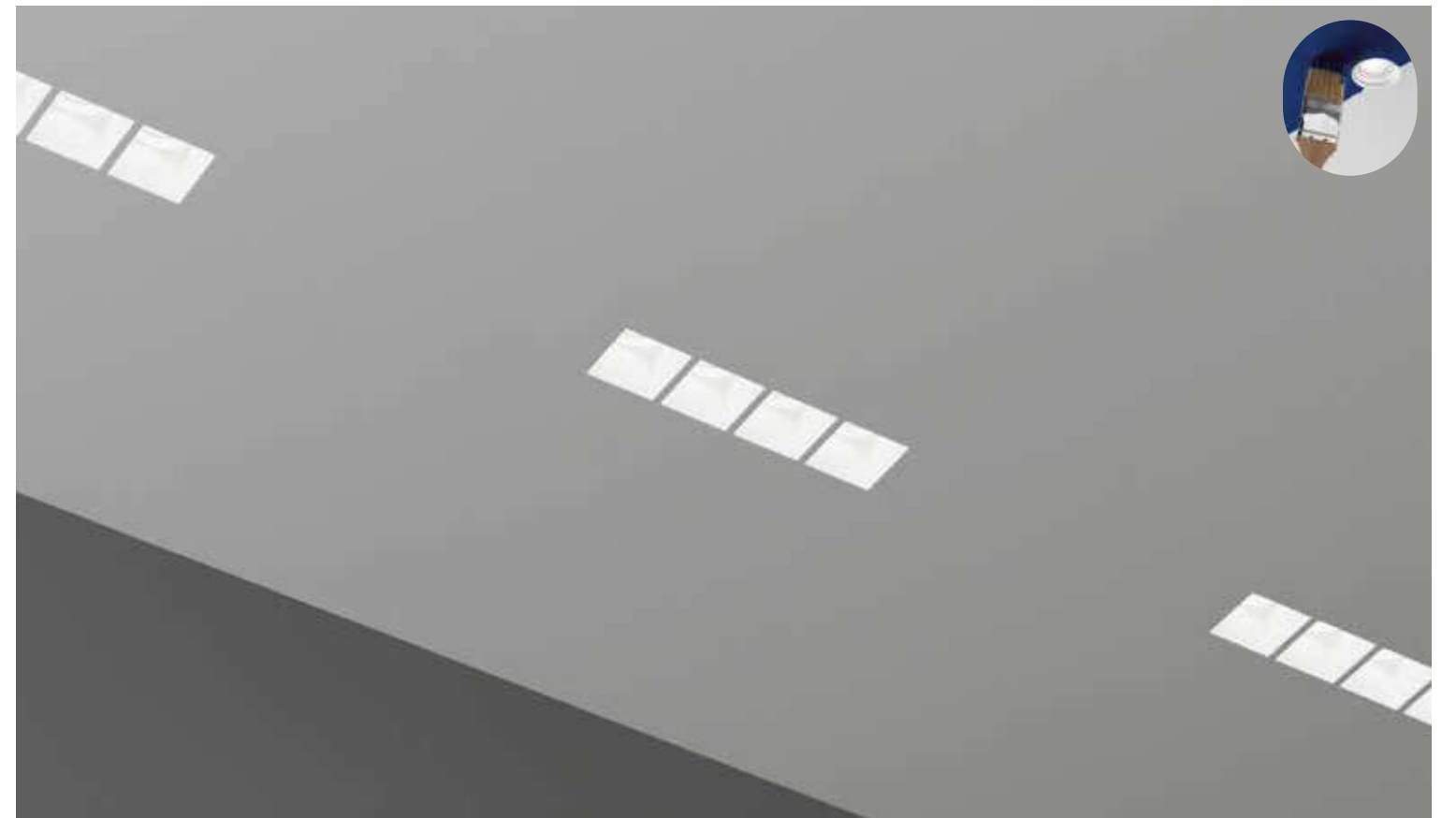
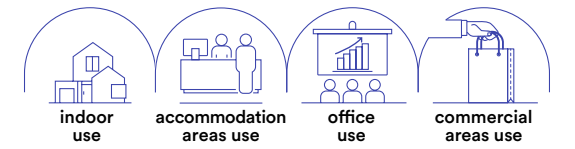

INC-HIVE-RT4
8031414884278

4 x MINI GU10 MAX 35W
bulb size \varnothing 34 mm
275 x 125 mm

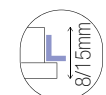
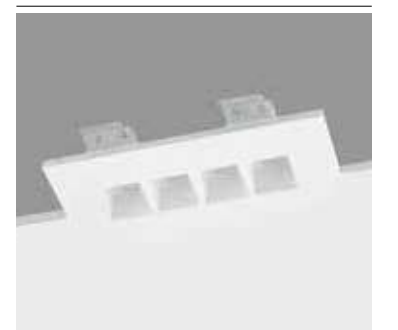
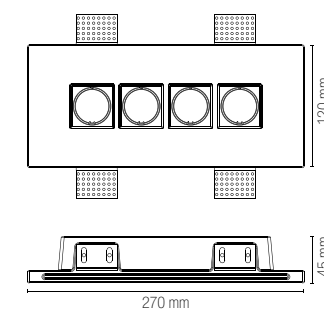

Staffa regolabile /
Adjustable bracket



Portalamпада incluso /
Lampholder included

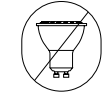

Lampadina non inclusa /
Light bulb not included



Portalamпада incluso /
Lampholder included



Lampadina non inclusa /
Light bulb not included

SPIRIT

Incasso in gesso verniciabile da integrare nel cartongesso per dare omogeneità tra parete e corpo illuminante.

Recessed gypsum downlight to be integrated into the plasterboard to give homogeneity between the ceiling and the lighting body.

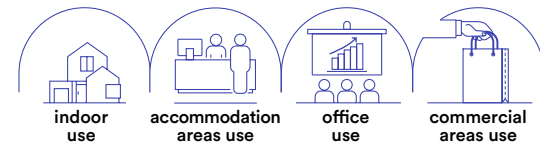

INC-SPIRIT-R1
8031440362177

1 x GU10 MAX 35W
Ø 103 mm



INC-SPIRIT-Q1
8031440362160

1 x GU10 MAX 35W
103 x 103 mm

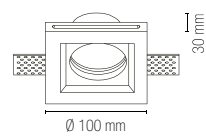
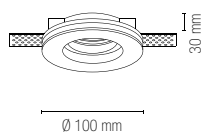

Portalamпада incluso /
Lampholder included



Lampadina non inclusa /
Light bulb not included

SNOW

Incasso in gesso verniciabile con diffusore in vetro satinato da integrare nel cartongesso per dare omogeneità tra soffitto e corpo illuminato.

Recessed paintable gypsum downlight with satin glass diffuser to be integrated into the plasterboard to give homogeneity between the ceiling and the lighting body.

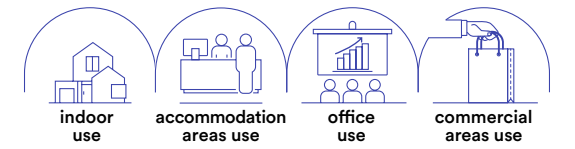

INC-SNOW-R
8031440351607

1 x GU10 MAX 10W
Ø 125 mm



INC-SNOW-Q
8031440351577

1 x GU10 MAX 10W
125 x 125 mm

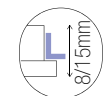

Staffa regolabile /
Adjustable bracket



Portalamпада incluso /
Lampholder included



Lampadina non inclusa /
Light bulb not included

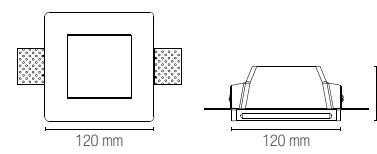
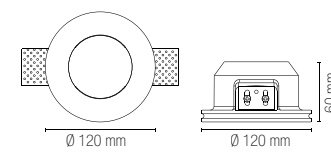

MORGANA

Incasso orientabile in gesso verniciabile da integrare nel cartongesso per dare omogeneità tra soffitto e corpo illuminante.

Adjustable and paintable recessed gypsum downlight to be integrated into the plasterboard to give homogeneity between ceiling and the lighting body.

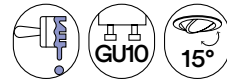
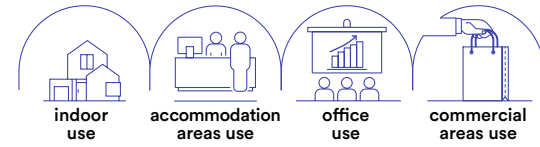

INC-MORGANA-R1
8031434211214

1 x GU10 MAX 35W
Ø 155 mm

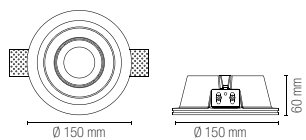

INC-MORGANA-Q1
8031434231212

1 x GU10 MAX 35W
160 x 160 mm

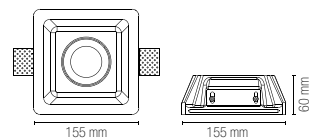

INC-MORGANA-Q2
8031434201215

2 x GU10 MAX 35W
260 x 160 mm

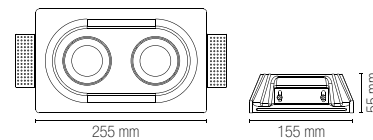

87,5 mm
Staffa regolabile /
Adjustable bracket

Portalamпада incluso /
Lampholder included

Lampadina non inclusa /
Light bulb not included

SENSO

Incasso in gesso verniciabile da integrare nel cartongesso per dare omogeneità tra soffitto e corpo illuminante.

Recessed gypsum paintable downlight to be integrated into the plasterboard to give homogeneity between ceiling and the lighting body.

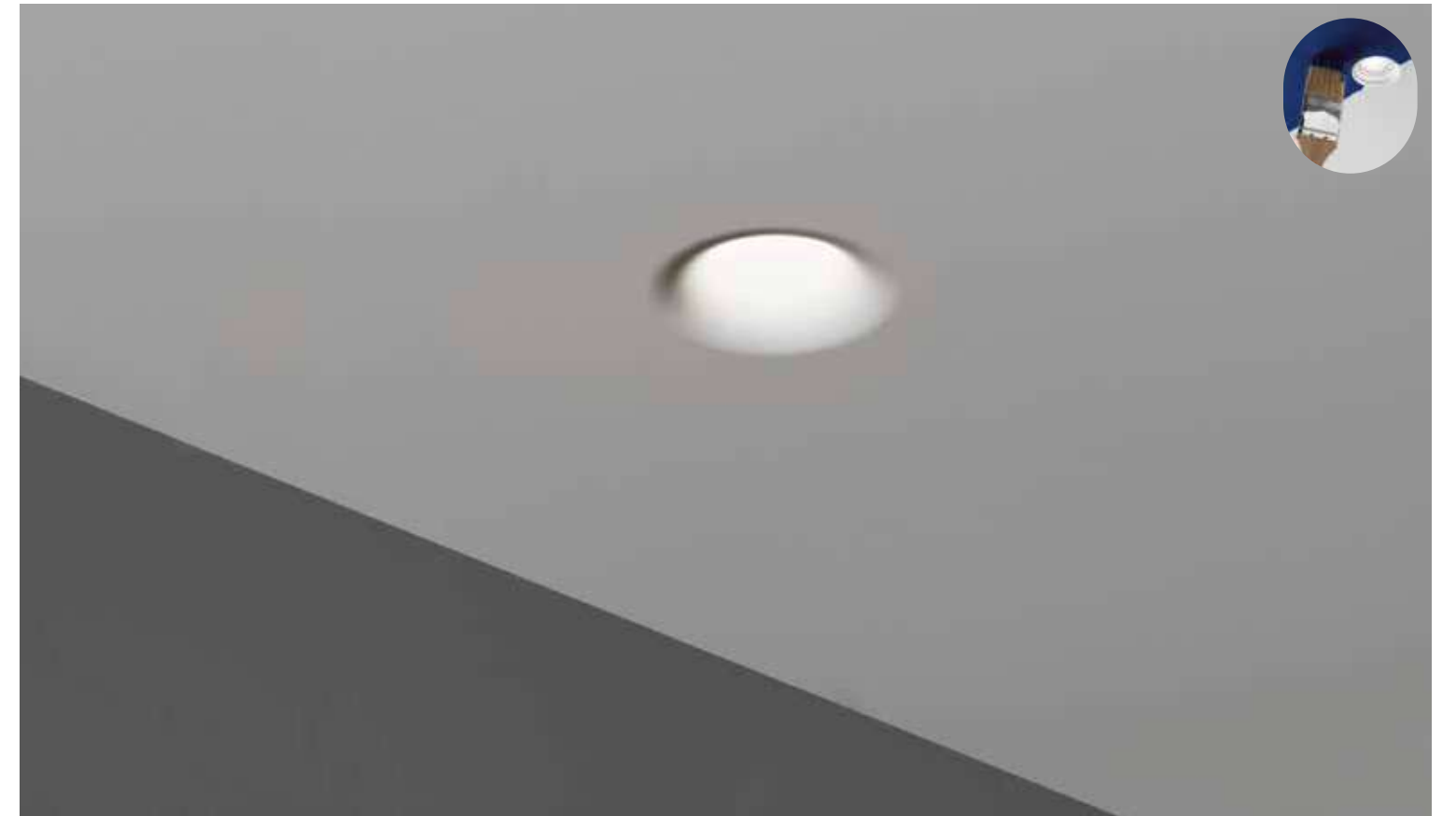
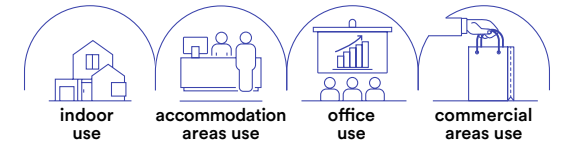

INC-SENSO-MINI
8031414892723

1 x MINI GU10 MAX 10W
80 x 80 mm

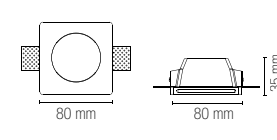

INC-SENSO-1
8031434221213

1 x GU10 MAX 35W
125 x 125 mm

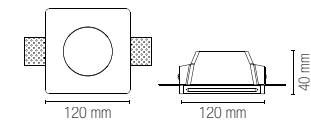

INC-SENSO-2
8031414873593

2 x GU10 MAX 35W
243 x 123 mm

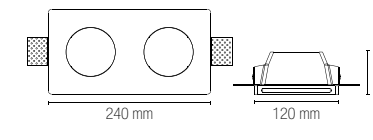

87,5 mm
Staffa regolabile /
Adjustable bracket

Portalamпада incluso /
Lampholder included

Lampadina non inclusa /
Light bulb not included

BRICK

Incasso in gesso verniciabile da integrare nel cartongesso per dare omogeneità tra soffitto e corpo illuminante con steli dalle forme modulari che sporgono dalla parete.
 Recessed gypsum paintable downlight to be integrated into the plasterboard to give homogeneity between ceiling and the lighting body with modular stems protruding from the wall.

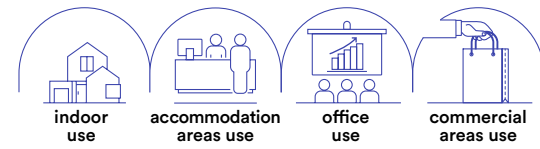

INC-BRICK-Q1
8031414873586

1 x GU10 MAX 35W
 123 x 123 mm

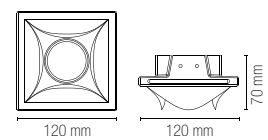

 Staffa regolabile /
Adjustable bracket

 Portalampada incluso /
Lampholder included

 Lampadina non inclusa /
Light bulb not included

EVA

Struttura ad incasso a scomparsa in gesso verniciabile da integrare nel cartongesso per dare omogeneità tra soffitto e corpo illuminante.
 Recessed structure in paintable gypsum to be integrated into the plasterboard to give homogeneity between the ceiling and lighting body.

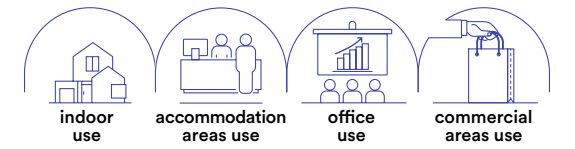

INC-EVA-R1
8031414873609

1 x E27 MAX 35W
 Ø 185 mm

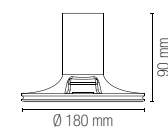

 Portalampada incluso /
Lampholder included

 Lampadina non inclusa /
Light bulb not included

SKILIFT

Sistema componibile da incasso in gesso verniciabile da integrare nel cartongesso per dare omogeneità tra soffitto e corpo illuminante.
Modular recessed system in paintable gypsum to be integrated into the plasterboard to give homogeneity between the ceiling and the lighting body.

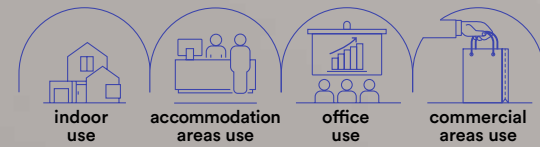

technical information **SKILIFT**



INC-SKILIFT-40CM
8031414884346
405 x 115 mm

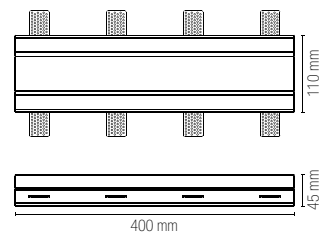

INC-SKILIFT-20CM
8031414884322
205 x 115 mm

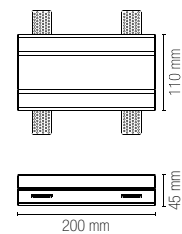

INC-SKILIFT-L16CM
8031414884360
165 x 165 mm

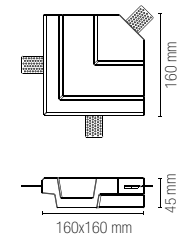

NC-SKILIFT-CAP
8031414886869
55 x 115 mm

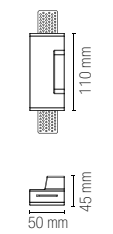

INC-SKILIFT-6
8031414884339
6 x MINI GU10 MAX 35W
bulb size Ø 34 mm
405 x 115 mm

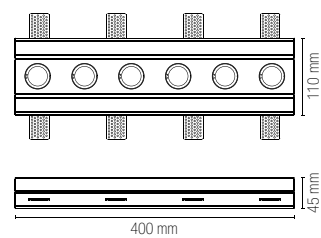

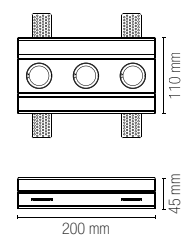

INC-SKILIFT-3
8031414884315
3 x MINI GU10 MAX 35W
bulb size Ø 34 mm
205 x 115 mm

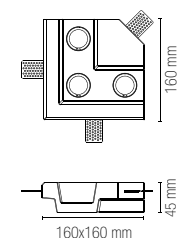

INC-SKILIFT-L3
8031414884353
3 x MINI GU10 MAX 35W
bulb size Ø 34 mm
165 x 165 mm



-  Portalamпада incluso / Lampholder included
-  Lampadina non inclusa / Light bulb not included

ARIEL

Segnapasso in gesso verniciabile da integrare nel cartongesso per dare omogeneità tra parete e corpo illuminante.

Paintable gypsum wall-light to be integrated into the plasterboard to give homogeneity between the wall and lighting body.

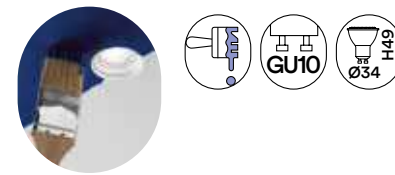
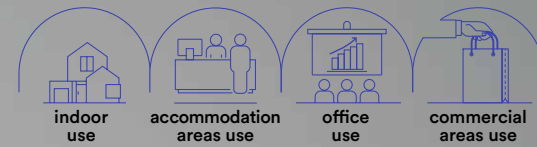

technical information **ARIEL**



I-ARIEL-QL1
8031434151213

1 x MINI GU10 MAX 35W
bulb size \varnothing 34 mm
115 x 250 x 12 mm

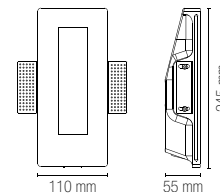

I-ARIEL-QL1-BOX
8031414868360

Cassa di derivazione opzionale per fissaggio a parete in muratura materiale alluminio / Aluminum optional recess box for brickwork recess installation

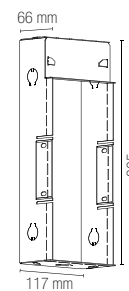

I-ARIEL-RM1
8031434121216

1 x MINI GU10 MAX 35W
bulb size \varnothing 34 mm
125 x 185 x 12 mm

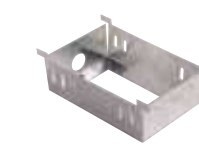
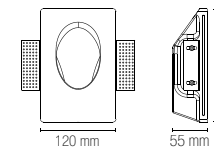

I-ARIEL-RM1-BOX
8031414868384

Cassa di derivazione opzionale per fissaggio a parete in muratura materiale alluminio / Aluminum optional recess box for brickwork recess installation

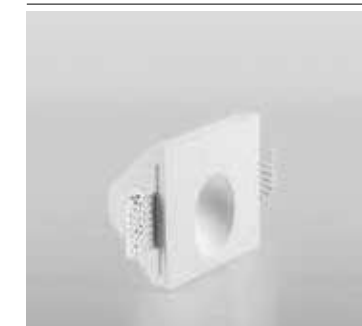
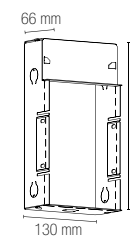

I-ARIEL-RS1
8031434131215

1 x MINI GU10 MAX 35W
bulb size \varnothing 34 mm
105 x 105 x 12 mm

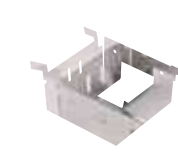
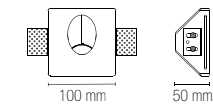

I-ARIEL-RS1-BOX
8031414868377

Cassa di derivazione opzionale per fissaggio a parete in muratura materiale alluminio / Aluminum optional recess box for brickwork recess installation

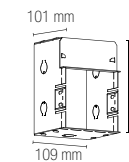

Staffa regolabile / Adjustable bracket



Portalamпада incluso / Lampholder included



Lampadina non inclusa / Light bulb not included

In.tec light **INCASSI / RECESSED LAMPS**

ANIMA

Applique in gesso verniciabile con leggera sporgenza da integrare nel cartongesso per dare omogeneità tra parte e corpo illuminante.
Wall lamp in paintable gypsum with slight protrusion to be integrated into the plasterboard to give homogeneity between the part and the illuminating body.

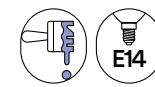
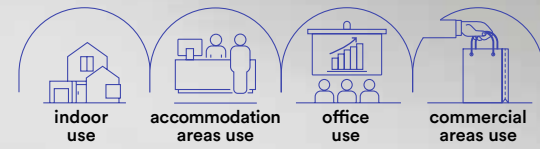

technical information **ANIMA**

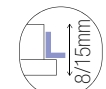
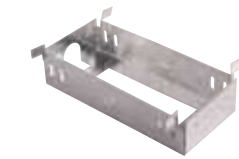

Staffa regolabile / Adjustable bracket



Portalampada incluso / Lampholder included



Lampadina non inclusa / Light bulb not included

I-ANIMA-AP2
8031414861323

2 x E14 MAX 14W
320 x 260 x 90 mm

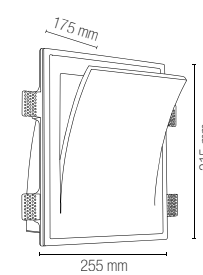

I-ANIMA-AP2-BOX
8031414868391

Cassa di derivazione opzionale per fissaggio a parete in muratura materiale alluminio / Aluminum optional recess box for brickwork recess installation

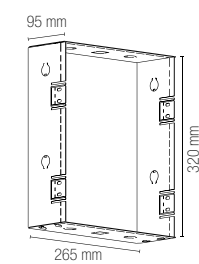

STENOS

Faretto da incasso con struttura in termoplastica orientabile ed antiriflesso.
Recessed spotlight with adjustable and anti-reflective thermoplastic structure.

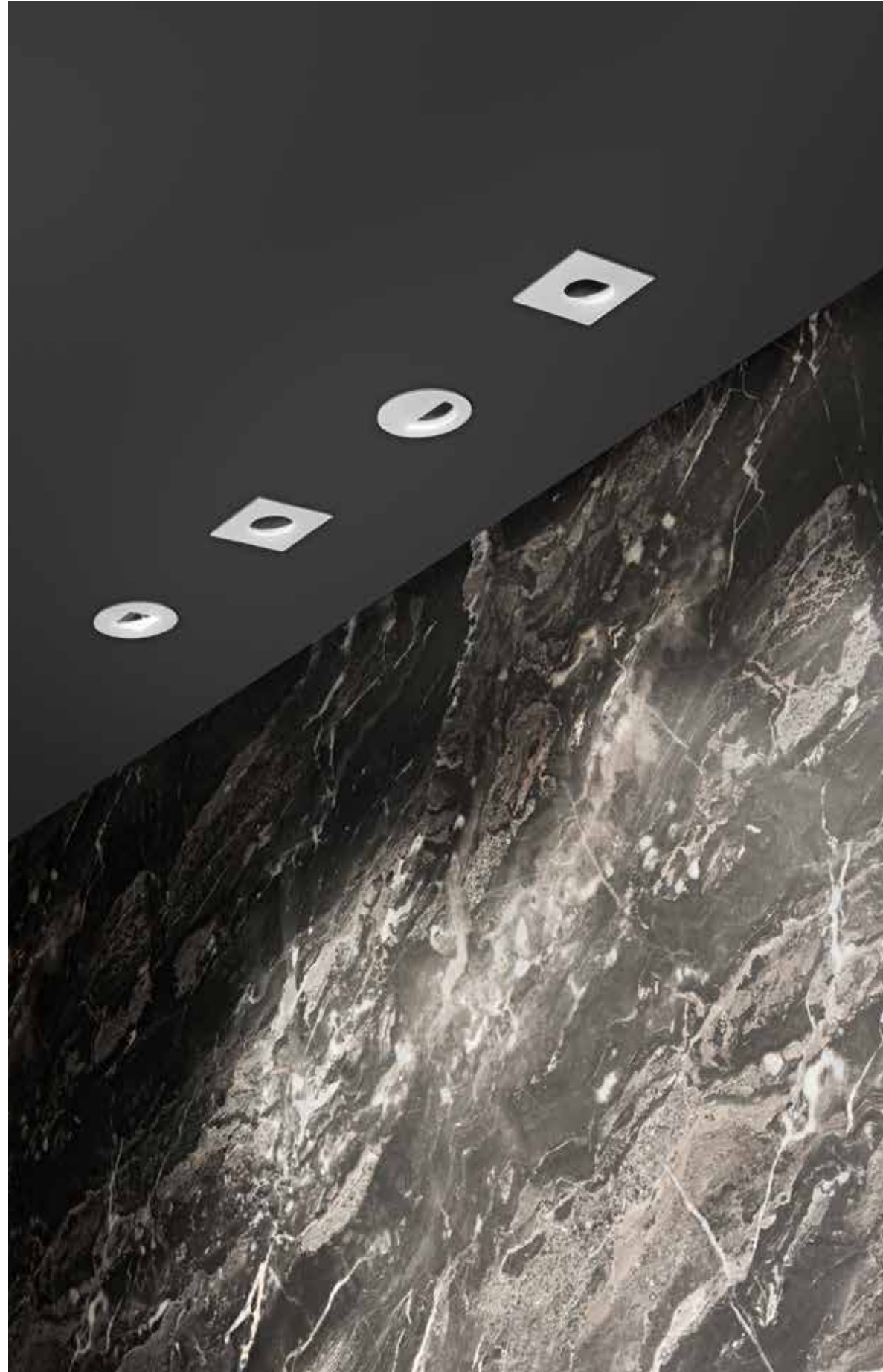
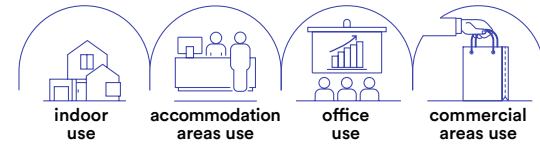

technical information **STENOS**



INC-STENOS-R-OV
8031414875818



INC-STENOS-Q-OV
8031414875856



INC-STENOS-R-QU
8031414875832



INC-STENOS-Q-QU
8031414875870



INC-STENOS-R-RO
8031414875801



INC-STENOS-Q-RO
8031414875849



INC-STENOS-R-ML
8031414875825



INC-STENOS-Q-ML
8031414875863

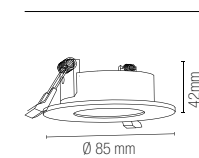

Ø 75 mm

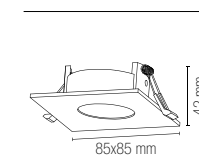

Ø 75 mm



Lampadina non inclusa / Light bulb not included



Portalamпада GU10 o MR16 non inclusi / GU10 or MR16 lamp holder not included





Lampadina non inclusa / Light bulb not included



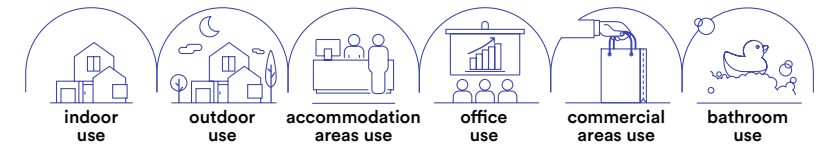

Portalamпада GU10 o MR16 non inclusi / GU10 or MR16 lamp holder not included





Faretto con struttura in metallo e diffusore in vetro satinato.
Spotlight with metal structure and satin glass diffuser.

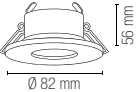

-   Portalampada GU10 o MR16 non inclusi / GU10 or MR16 lamp holder not included
-  Lampadina non inclusa / Light bulb not included



	colour
INC-VIPER-R-BCO 8031414861590	
INC-VIPER-R-NIK 8031414861576	
	Ø 74 mm

-   Portalampada GU10 o MR16 non inclusi / GU10 or MR16 lamp holder not included
-  Lampadina non inclusa / Light bulb not included

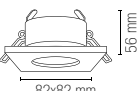

	colour
INC-VIPER-Q-BCO 8031414861866	
INC-VIPER-Q-NIK 8031414861873	
	82x82 mm



Faretto ad incasso antiriflesso in alluminio nero o bianco goffrato.
Recessed spotlight with anti-reflective in black or white embossed aluminum.



Portalamпада incluso /
Lampholder included



Lampadina non inclusa /
Light bulb not included



Portalamпада incluso /
Lampholder included



Lampadina non inclusa /
Light bulb not included

		colour
	INC-AYRIS-R BCO 8031414868216	
	INC-AYRIS-R NER 8031414868193	
1 x GU10 MAX 35W 		Ø 75 mm

		colour
	INC-AYRIS-Q BCO 8031414868223	
	INC-AYRIS-Q NER 8031414868186	
1 x GU10 MAX 35W 		72 x 72 mm

REFLEX



Incasso in metallo Metal down light

INC-REFLEX-SF1 BCO
8031439321260

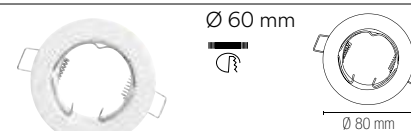

INC-REFLEX-SF1 NER
8031414861552



INC-REFLEX-SF1 CR
8031439301262



INC-REFLEX-SF1 ORO
8031439341268



INC-REFLEX-SF1 NIK
8031439311261



INC-REFLEX-SF1 BR
8031439331269



INC-REFLEX-Q-SF1 BCO
8031414861538



INC-REFLEX-Q-SF1 NER
8031414885053



INC-REFLEX-Q-SF1 NIK
8031414861545



Lampadina
non inclusa /
Light bulb
not included



Portalampada GU10
o MR16 non inclusi/
GU10 or MR16 lamp
holder not included

Incasso in metallo orientabile Metal down light adjustable



INC-REFLEX-SM1 BCO
8031439251260

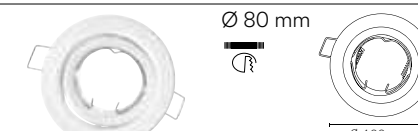

INC-REFLEX-SM1 NER
8031414861569



INC-REFLEX-SM1 CR
8031439281267



INC-REFLEX-SM1 ORO
8031439271268



INC-REFLEX-SM1 NIK
8031439261269



INC-REFLEX-SM1 BR
8031439291266



INC-REFLEX-Q-SM1 BCO
8031440363310

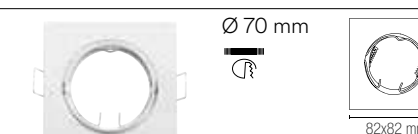

INC-REFLEX-Q-SM1 NER
8031414885060



INC-REFLEX-Q-SM1 NIK
8031440363280



Lampadina
non inclusa /
Light bulb
not included



Portalampada GU10
o MR16 non inclusi/
GU10 or MR16 lamp
holder not included

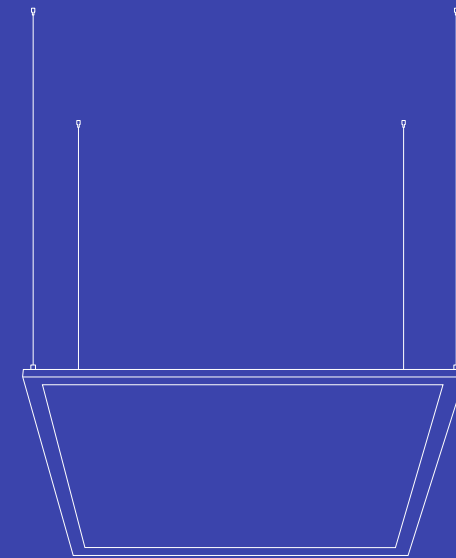

SISTEMI D'ILLUMINAZIONE MULTIFUNZIONE

MULTI-FUNCTION LIGHTING SYSTEM

SEGMENTO

Supporto lineare modulare in acciaio rivestito in silicone nero.
Modular linear support in steel and coated in black silicone.

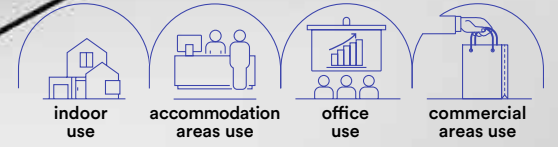

SISTEMI D'ILLUMINAZIONE MULTIFUNZIONE / MULTI-FUNCTION LIGHTING SYSTEM

In.tec light

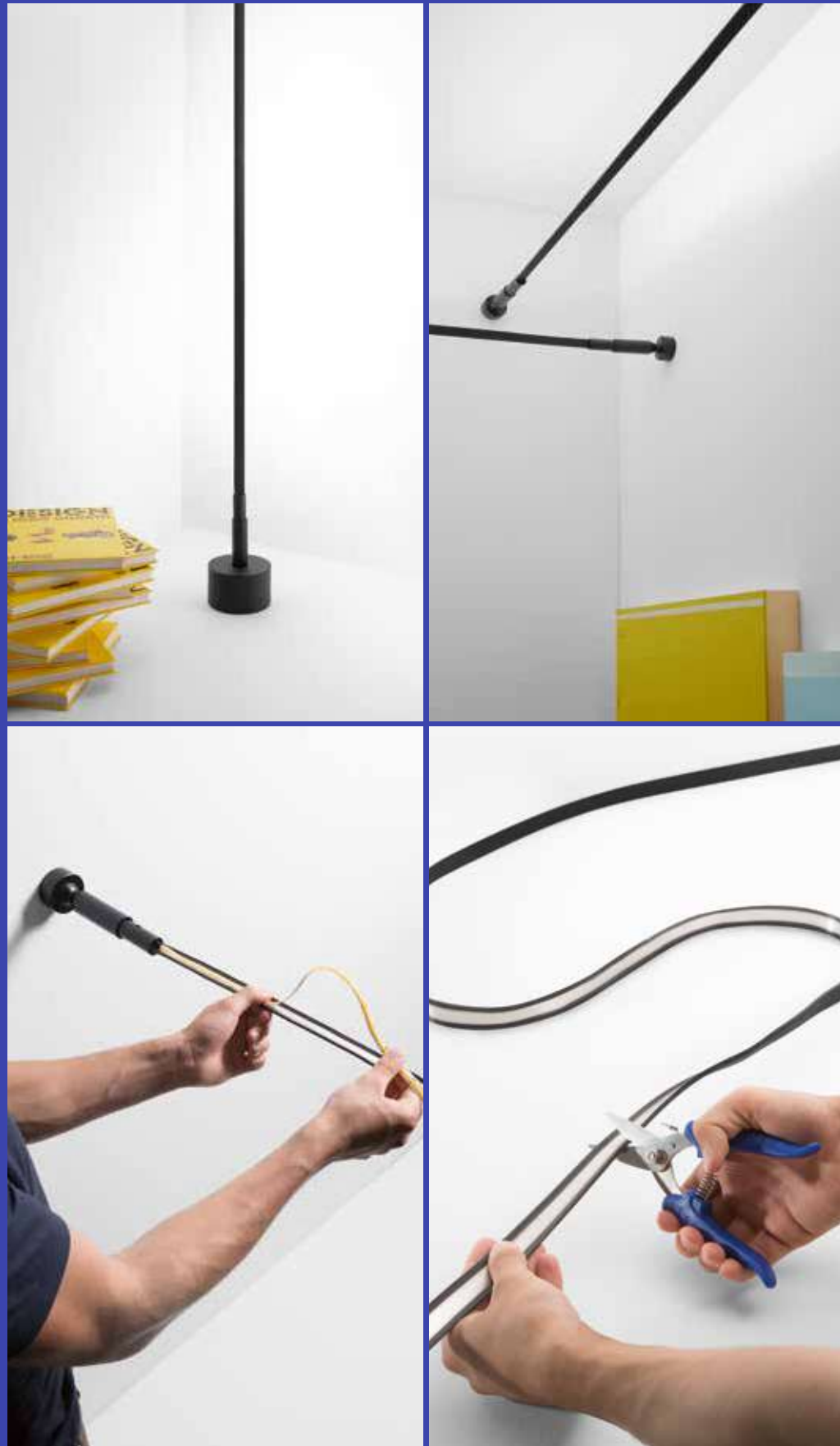

Supporto lineare modulare in acciaio rivestito in silicone nero.
Modular linear support in steel and coated in black silicone.



Strip LED non inclusa / Strip LED not included

Kit completo / Complete kit



I-SEGMENTO-6M
8031414882458

Kit base 6 m con nastro tagliabile /
6 m basic kit with cuttable ribbon

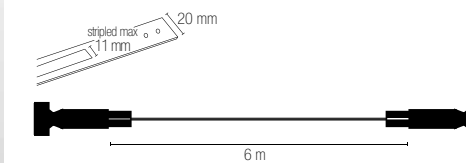

Accessori inclusi / Included accessories



Set di 2 basette ed accessori /
Set of 2 bases and accessories



Kit di arnesi / Tool kit

Elementi singoli per comporre il kit / Single elements to compose the kit

Servizio customizzato taglio su misura / Customized cut service



I-SEGMENTO-1M
8031414882441

TAGLIO 1 M NASTRO Indicare la misura desiderata nelle note del B2B (multipli di 1 metro) / **1 M TAPE CUT** Indicate the desired size in the B2B notes (multiples of 1 meter)

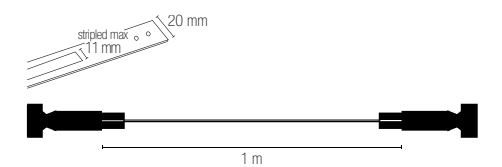

I-SEGMENTO-BASE
8031414894307

Base per piantana SEGMENTO /
Base for SEGMENTO floor lamp



I-SEGMENTO-FIX
8031414882465

Set di 2 basette ed accessori /
Set of 2 bases and accessories

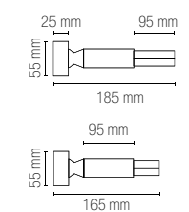

I-SEGMENTO-TOOL
8031414882472

Kit di arnesi /
Tool kit

METRO

Sistema cavi tesi con finitura cromo.
Wire system chrome system.

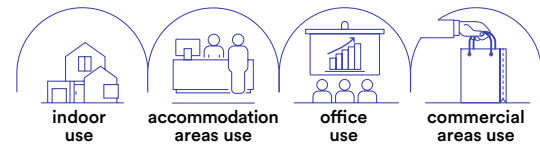

LED-METRO-5
8031414862139

5 x MR16 MAX 9W
Driver 50W included

5 m cable included

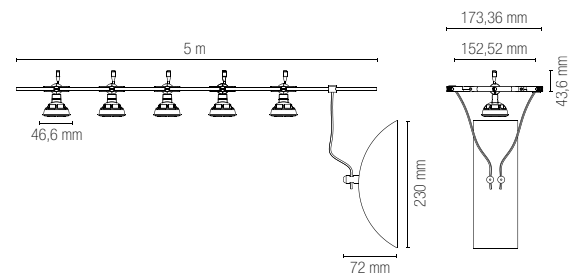

I-WIRE-10M
8031414870387

Cavo 10 m / 10 m cable



Lampadina non inclusa /
Light bulb not included

EUCLID

Sistema cavi tesi con finitura nikel.
Wire system nikel system.

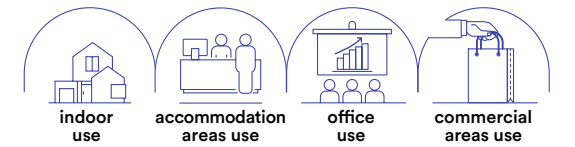

LED-EUCLID-5
8031414862146

5 x MR16 MAX 9W
Driver 50W included

5 m cable included

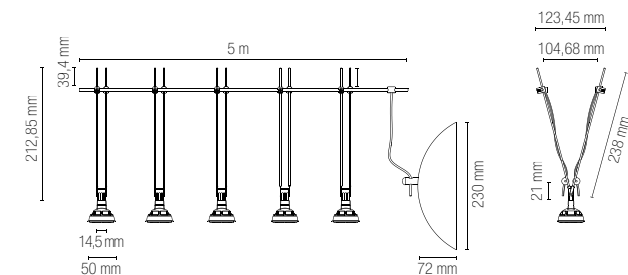

I-WIRE-10M
8031414870387

Cavo 10 m / 10 m cable



Lampadina non inclusa /
Light bulb not included

BUILD

Barra a LED in alluminio bianco o nero goffrato.
LED bar in aluminum finish embossed white or black.

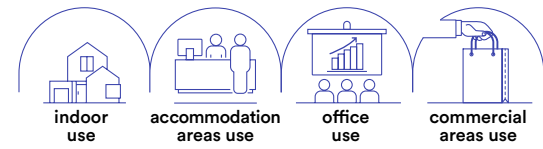

Materiale
alluminio

Colore
bianco goffrato
nero goffrato



Temperatura colore
3000K / 4000K



Driver
incluso

Material
aluminum

Colour
embossed white
embossed black



Colour temperature
3000K / 4000K



Driver
included



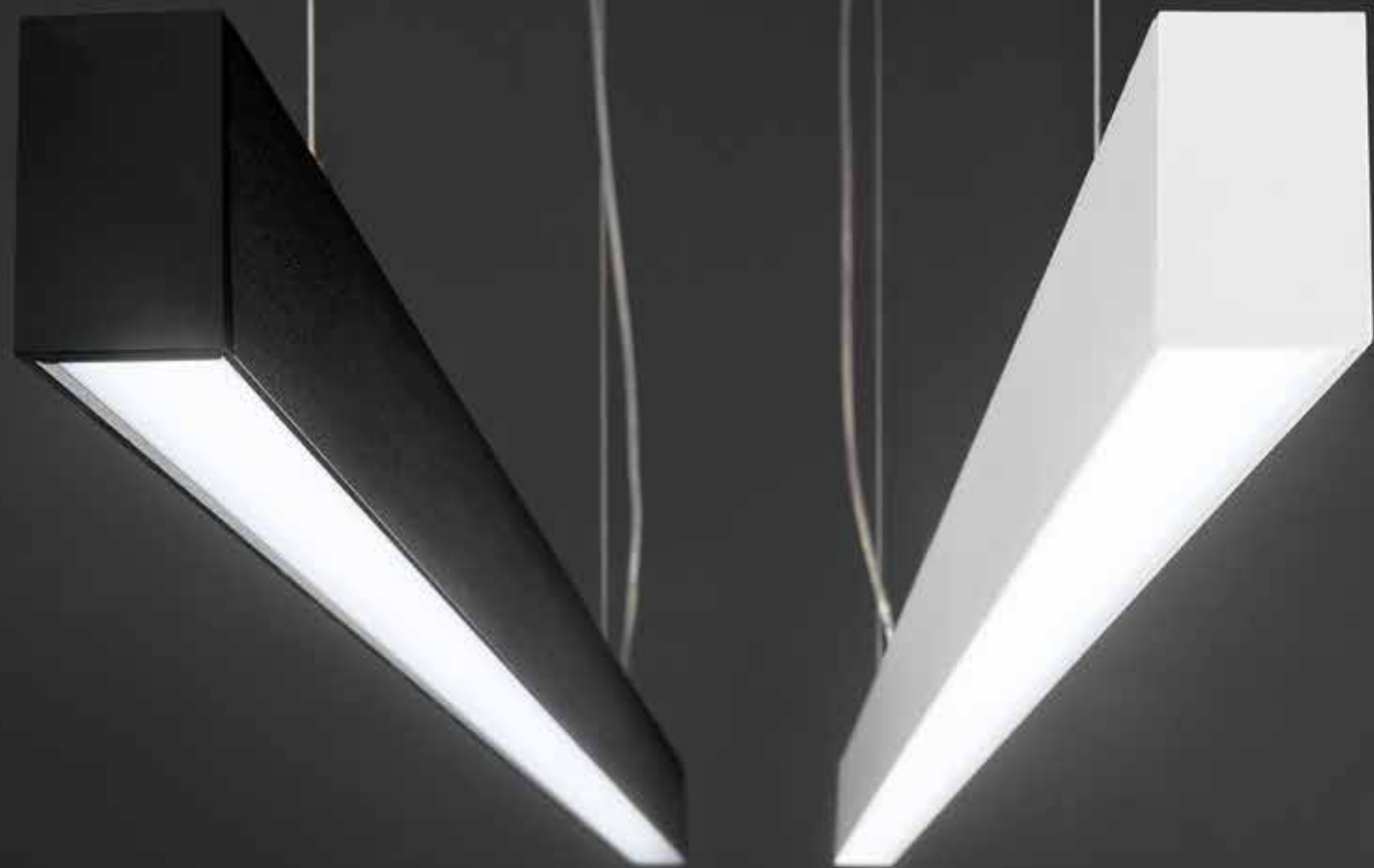

technical information **BUILD**



	colour temp.	colour
LED-BUILD-W-1C 8031414897445 lumen		
LED-BUILD-W-1M 8031414867912 lumen		
LED-BUILD-B-1C 8031414896585 lumen		
LED-BUILD-B-1M 8031414867899 lumen		
watt	26W	
beam angle	87°	
pf	0.90	

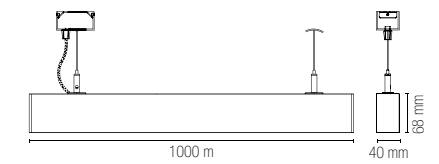

	colour temp.	colour
LED-BUILD-W-2C 8031414896578 lumen		
LED-BUILD-W-2M 8031414867950 lumen		
LED-BUILD-B-2C 8031414897452 lumen		
LED-BUILD-B-2M 8031414867936 lumen		
watt	26W	
beam angle	87°	
pf	0.90	

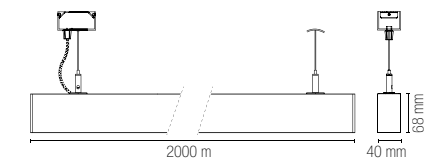

**Fotometria del prodotto /
Photometric curve**

Le curve fotometriche sopra indicate
rappresentano il singolo metro /
Above photometric curve
represent the single meter

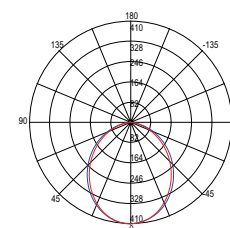

LED-BUILD 1M*

**Accessorio incluso /
Included accessory**

Kit cavi e fissaggio
a plafoniera /
Metal bracket and
steel hanging wire

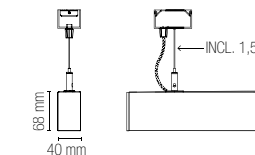

PANEL

Pannello a LED con struttura in alluminio e diffusore in acrilico bianco.

LED panel with aluminum structure and white acrylic diffuser.

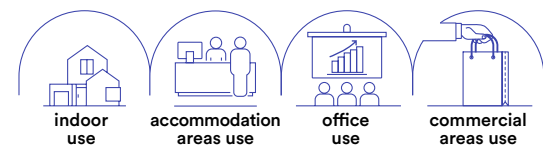

Materiale
alluminio,
diffusore in acrilico

Colore
bianco

Temperatura colore
3000K / 4000K / 6000K



Driver
incluso

Material
aluminum,
acrylic diffuser

Colour
white

Colour temperature
3000K / 4000K / 6000K



Driver
included



technical information **PANEL**



LED-PANEL-C-60X60BK

8031414885046

lumen



4260 lm

LED-PANEL-60X60BK

8031414874323

lumen



4939 lm

LED-PANEL-F-60X60BK

8031414874347

lumen



4806 lm

watt

40W

beam angle

120°

pf

0.90



590 × 590 mm

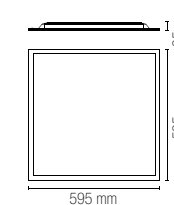

LED-PANEL-30X120BK

8031414874316

lumen



4510 lm

LED-PANEL-F-30X120BK

8031414874330

lumen



4426 lm

watt

40W

beam angle

120°

pf

0.90



290 × 1190 mm



LED-PANEL-60X60-SCH

8031414897612

lumen



4300 lm

watt

40W

beam angle

120°

pf

0.90



590 × 590 mm

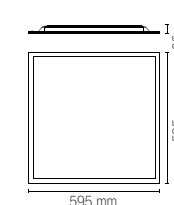

LED-PANEL-30X120-SCH

8031414897629

lumen



4300 lm

watt

40W

beam angle

120°

pf

0.90



290 × 1190 mm



Fotometria del prodotto / Photometric curve

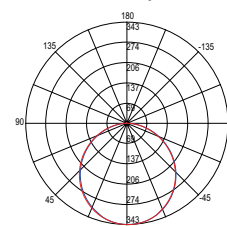

LED-PANEL-60X60 BK

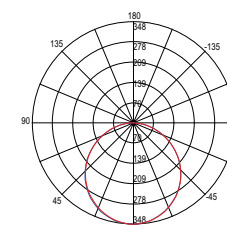

LED-PANEL-30X120 BK

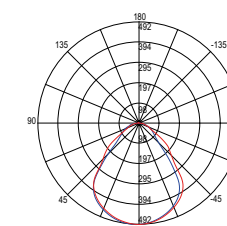

LED-PANEL-60X60-SCH

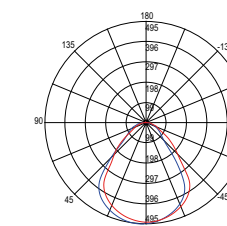

LED-PANEL-30X120-SCH

PANEL

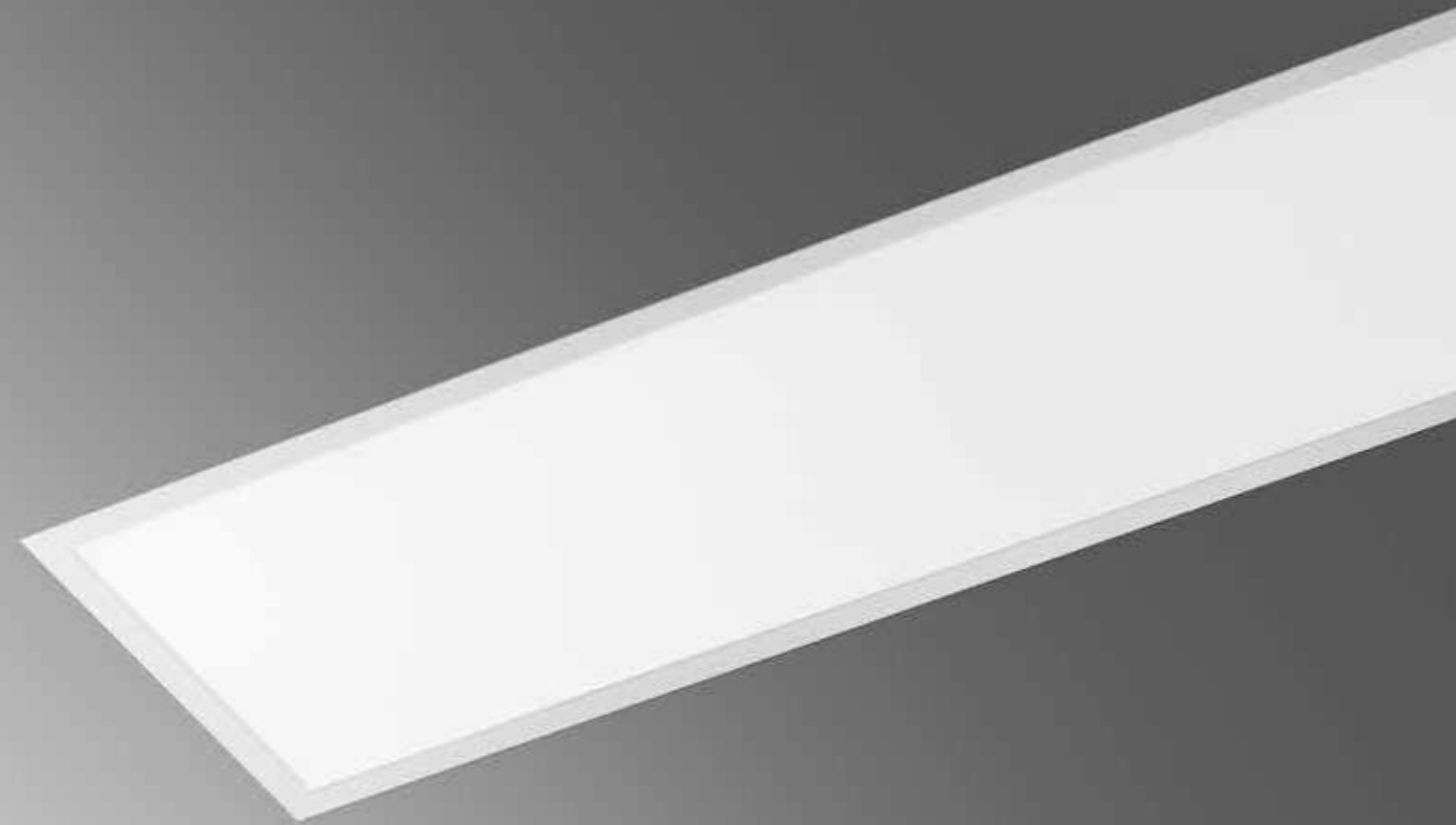

Materiale
alluminio,
diffusore in PMMA

Colore
bianco



Temperatura colore
4000K / 6500K



Driver
incluso

Durata e on/off
50.000h
>25.000 on/off

Material
aluminum,
PMMA diffuser

Colour
white



Colour temperature
4000K / 6500K



Driver
included

Lifetime and on/off
50.000h
>25.000 on/off

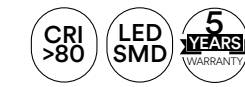

technical information **PANEL**



Pannello a LED con struttura in alluminio, diffusore in PMMA.

LED panel with aluminum structure, PMMA diffuser.



LED-PANEL-60X60-5Y

8031414875344

lumen

colour temp.



4669 lm

colour



4669 lm

LED-PANEL-F-60X60-5Y

8031414875368

lumen

colour temp.



4610 lm

colour



4610 lm

watt 40W
beam angle 110°
pf 0.90
590 × 590 mm

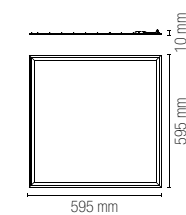

LED-PANEL-30X120-5Y

8031414871773

lumen

colour temp.



4669 lm

colour



4669 lm

LED-PANEL-F-30X120-5Y

8031414874354

lumen

colour temp.



4743 lm

colour



4743 lm

watt 40W
beam angle 110°
pf 0.90
290 × 1190 mm

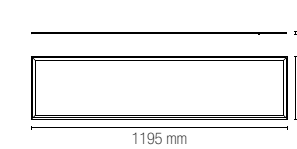

Fotometria del prodotto /
Photometric curve

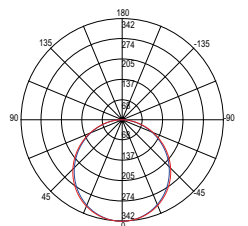

LED-PANEL-60X60 5Y

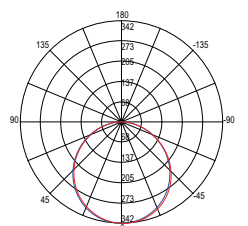

LED-PANEL-30X120 5Y

PANEL

Pannello a LED con struttura in alluminio e diffusore in acrilico bianco.
LED panel with aluminum structure and white acrylic diffuser.

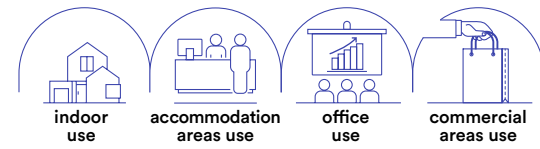

technical information **PANEL**



Materiale
alluminio,
diffusore in acrilico

Colore
bianco

Temperatura colore
4000K / 5000K



Driver
incluso

Material
aluminum,
acrylic diffuser

Colour
white

Colour temperature
4000K / 5000K



Driver
included



	colour temp.	colour
LED-PANEL-60X120 8031440361897 lumen		
	9298 lm	
LED-PANEL-F-60X120 8031440361873 lumen		
	9298 lm	
watt	60W	
beam angle	120°	
pf	0.90	
	590 x 1190 mm	



Fotometria del prodotto / Photometric curve

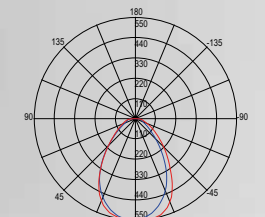

LED-PANEL-60X120

PANEL UGR

Pannello LED UGR<19.
LED panel UGR<19.

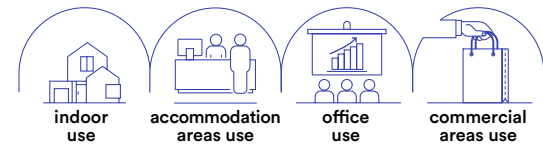

- Materiale**
alluminio,
diffusore in acrilico
- Colore**
bianco
- Temperatura colore**
4000K
- Driver**
incluso
- Material**
aluminum,
acrylic diffuser
- Colour**
white
- Colour temperature**
4000K
- Driver**
included

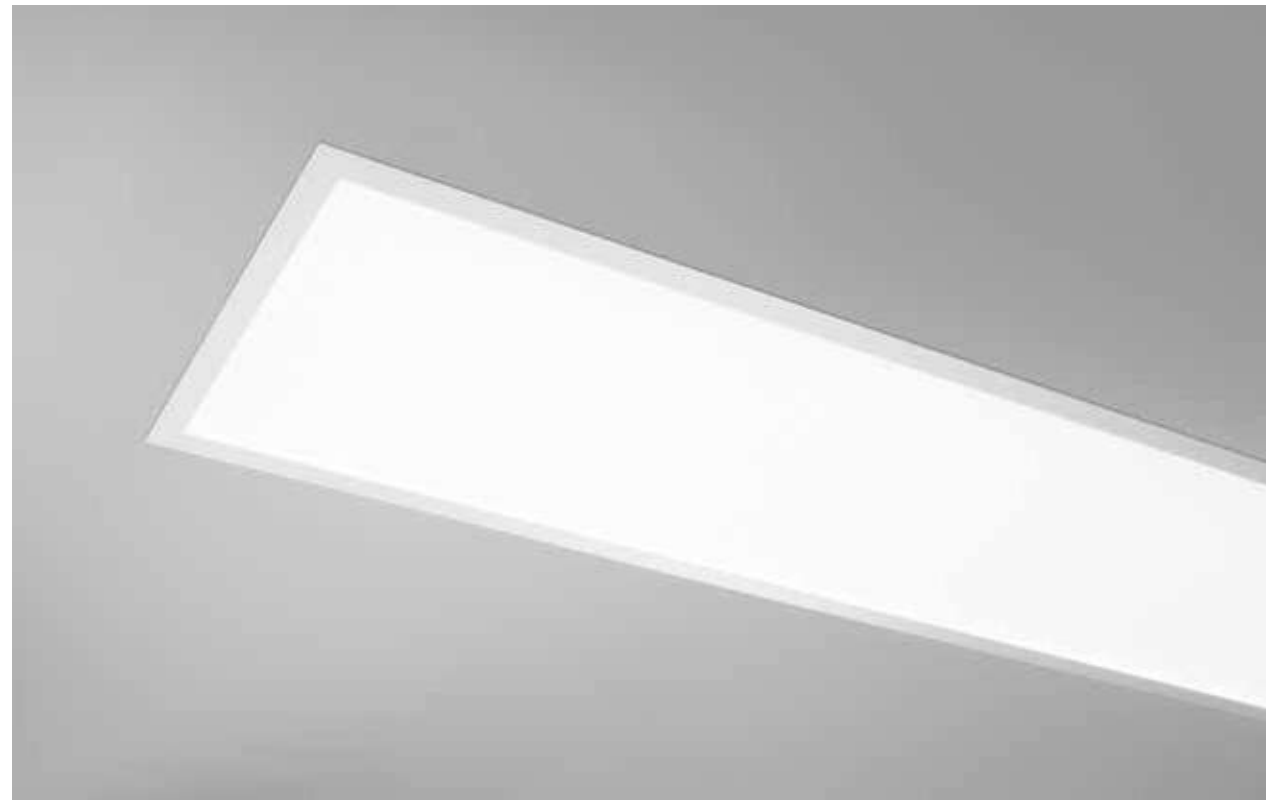

LED-PANEL-60X60-UGR
8031440357524
lumen

colour temp. | colour
4650 lm

watt 40W
beam angle 120°
pf 0.90
590 × 590 mm

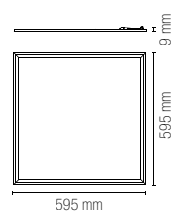

LED-PANEL-30X120-UGR
8031414878444
lumen

colour temp. | colour
3200 lm

watt 40W
beam angle 120°
pf 0.90
290 × 1190 mm

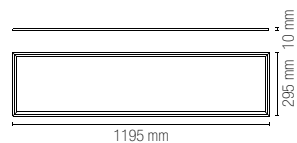

Fotometria del prodotto /
Photometric curve

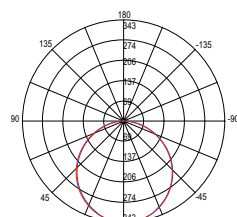

LED-PANEL-60X60 UGR

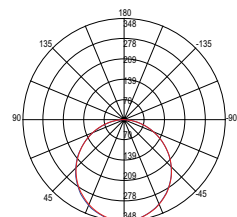

LED-PANEL-30X120 UGR

PANEL IP65

Pannello LED UGR<19 e IP65.
LED panel UGR<19 and IP65.

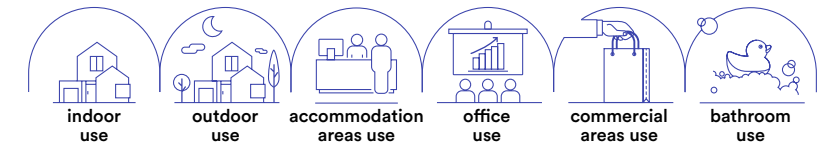

- Materiale**
alluminio,
diffusore in PMMA
- Colore**
bianco
- Temperatura colore**
4000K
- Driver**
incluso
- Material**
aluminum,
PMMA diffuser
- Colour**
white
- Colour temperature**
4000K
- Driver**
included

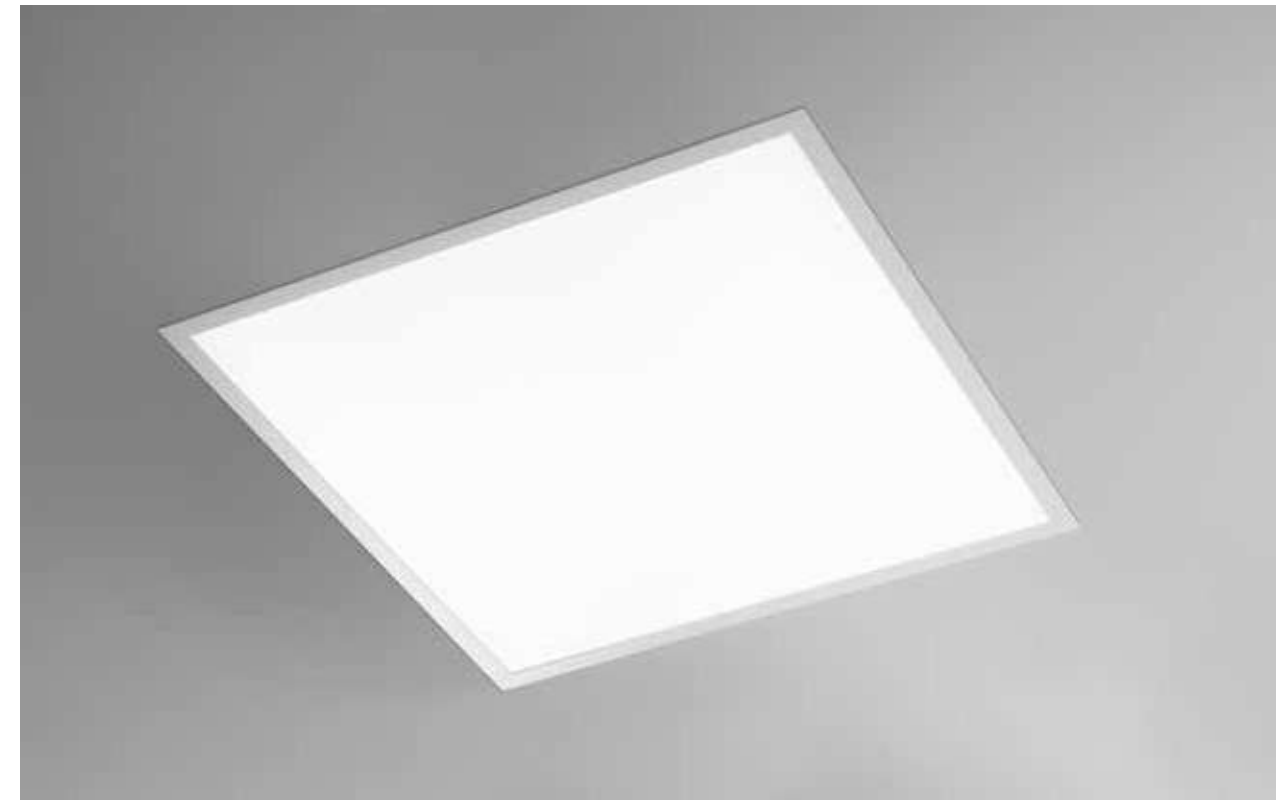

LED-PANEL-60X60-IP65
8031414876303
lumen

colour temp. | colour
3240 Lm

watt 36W
beam angle 120°
pf 0.90
590 × 590 mm

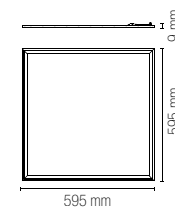

Fotometria del prodotto /
Photometric curve

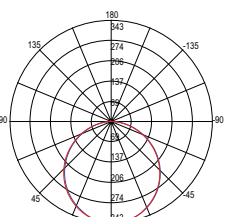

LED-PANEL-60X60 IP65 UGR

PANEL

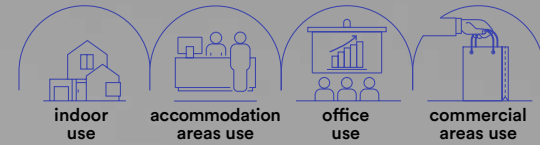

Materiale
alluminio,
diffusore in acrilico

Colore
bianco

Temperatura colore

4000K

Driver
incluso

Material
aluminum,
acrylic diffuser

Colour
white

Colour temperature

4000K

Driver
included



technical information **PANEL**



Sensore crepuscolare /
Adjustable light intensity through Harvest lux sensor

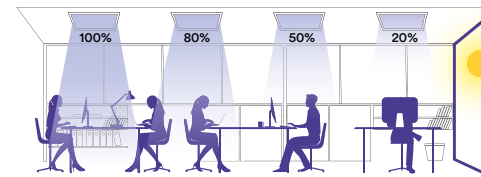

Pannello a LED con struttura in alluminio, diffusore in acrilico e finitura in bianco. Sistema di variazione di intensità luminosa intelligente tramite sensore LUX integrato.
LED panel with aluminum structure, acrylic diffuser and white finish. Adjustable light intensity through built-in harvest LUX sensor.



LED-PANEL-60X60-SENS

8031414861897
lumen

colour temp.	colour
4000 Lm	

watt	40W
beam angle	120°
pf	0.90

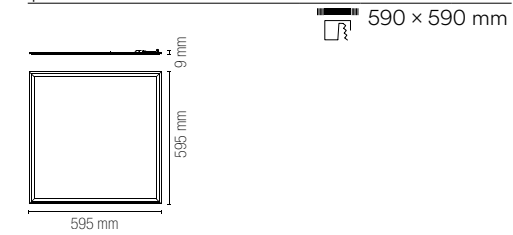

**Fotometria del prodotto /
Photometric curve**

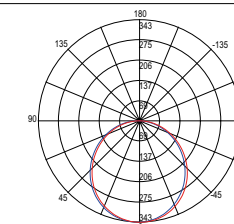

LED-PANEL-60X60-SENS

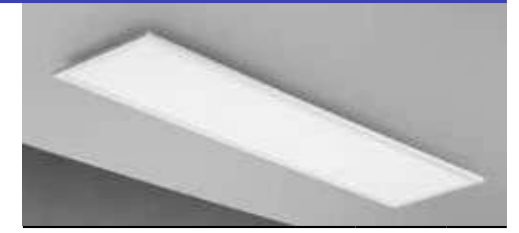

LED-PANEL-30X120-SENS

8031414861880
lumen

colour temp.	colour
4000 Lm	

watt	40W
beam angle	120°
pf	0.90

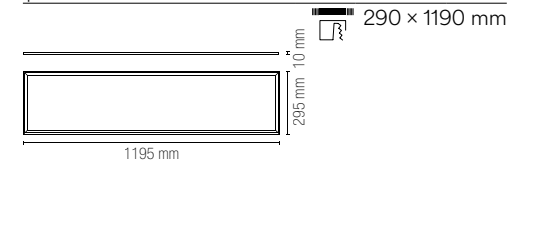

**Fotometria del prodotto /
Photometric curve**

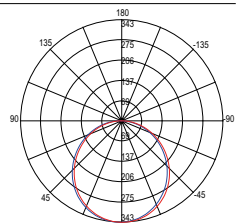

LED-PANEL-30X120-SENS

3 step dimmer x1 100% x2 50% x3 10%
3 step dimming function x1 100% x2 50% x3 10%

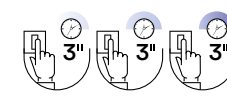

x1-100% x2-50% x3-10%

Pannello a LED con struttura in alluminio, diffusore in acrilico e finitura in bianco. Sistema di variazione intensità di luce in 3 step tramite interruttore.

LED panel with aluminum structure, acrylic diffuser and white finish. Light intensity variation system in 3 steps via switch.



LED-PANEL-60x60-DIM

8031414861026
lumen

colour temp.	colour
3600 Lm	

watt	40W
beam angle	120°
pf	0.90

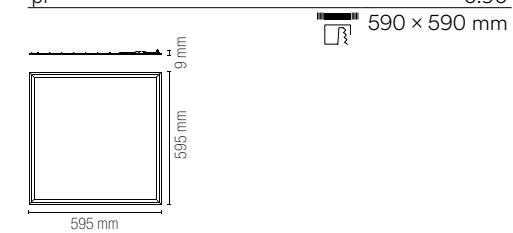

**Fotometria del prodotto /
Photometric curve**

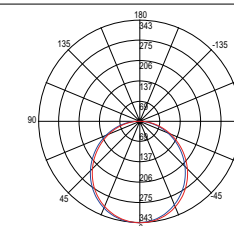

LED-PANEL-60X60-DIM



LED-PANEL-30x120-DIM

8031414861033
lumen

colour temp.	colour
3600 Lm	

watt	40W
beam angle	120°
pf	0.90

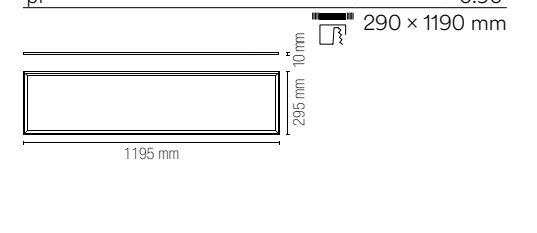

**Fotometria del prodotto /
Photometric curve**

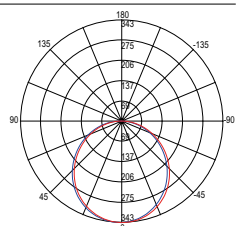

LED-PANEL-30X120-DIM

PANEL

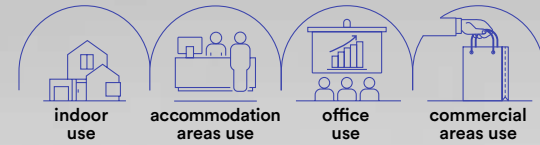

Materiale
alluminio,
diffusore in acrilico

Colore
bianco



Driver
incluso

Dimmer
dimmerabile
con radiocomando
incluso

Material
aluminum,
acrylic diffuser

Colour
white



Driver
included

Dimmer
dimmable with radio
frequency remote control
included



technical information **PANEL**



Pannello a LED con struttura in alluminio, diffusore in acrilico e finitura in bianco. Sistema di variazione gradi Kelvin e intensità di luce, con radiocomando incluso.
LED panel with aluminum structure, acrylic diffuser and white finish. Adjustable kelvin and luminous flux with radio frequency remote control included.

LED-PANEL-60x60-CCT
8031414861040

lumen	4650 lm
watt	40W
beam angle	120°
pf	0.90

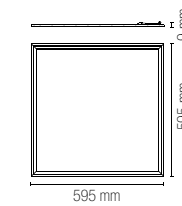

LED-PANEL-30x120-CCT
8031414861057

lumen	3600 lm
watt	40W
beam angle	120°
pf	0.90

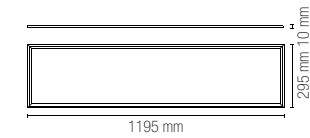

Accessorio incluso /
Included accessory

Telecomando incluso /
Remote control included

Fotometria del prodotto /
Photometric curve

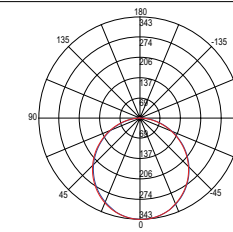

LED-PANEL-60x60-CCT

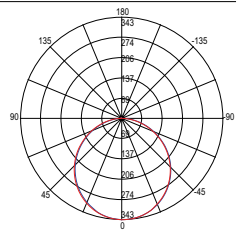

LED-PANEL-30x120-CCT



Pannello a LED con struttura in alluminio, diffusore in acrilico e finitura in bianco. Sistema di variazione colorazione luce RGB e luce bianca, con radiocomando incluso.
LED panel with aluminum structure, acrylic diffuser and white finish. RGB and natural white light adjustable with radio frequency remote control included.

LED-PANEL-60x60-RGBW
8031414861064

lumen	4150 lm
watt	40W
beam angle	120°
pf	0.90

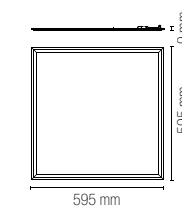

Accessorio incluso /
Included accessory

Telecomando incluso /
Remote control included

Fotometria del prodotto /
Photometric curve

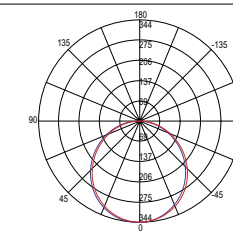

LED-PANEL-60x60-RGBW

PANEL

Pannello LED a cornice luminosa.
LED panel with light frame.

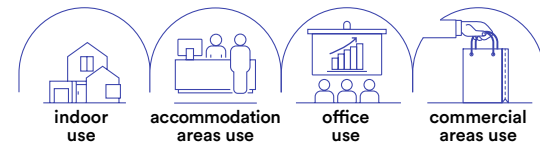

- Materiale**
alluminio,
diffusore in PMMA
- Colore**
bianco
- Temperatura colore**
CCT
- Driver**
incluso
- Material**
aluminum,
PMMA diffuser
- Colour**
white
- Colour temperature**
CCT
- Driver**
included

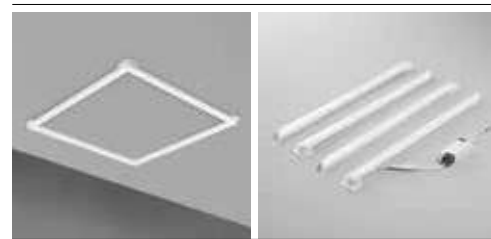
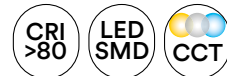

LED-PANEL-60X60-FR
8031414897643

lumen

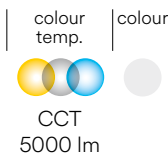

watt	40W
beam angle	120°
pf	0.90
□	590 × 590 mm

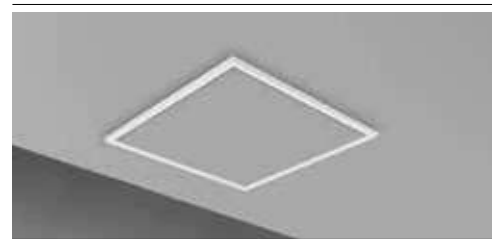
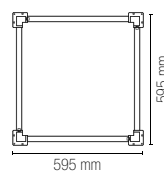

LED-PANEL-60X60-EDG
8031414897650

lumen

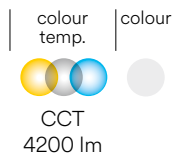

watt	42W
beam angle	120°
pf	0.90
□	590 × 590 mm

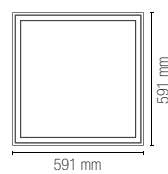

Fotometria del prodotto / Photometric curve

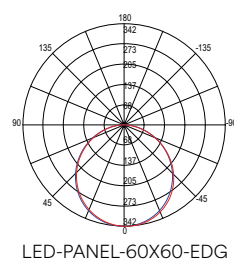
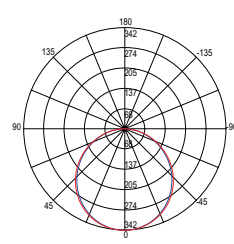

PANEL

Pannello a LED, fissaggio easy a soffitto.
LED panel, easy ceiling fixing.

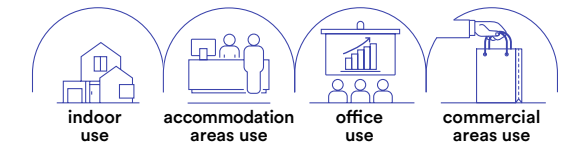

- Materiale**
alluminio,
diffusore in PMMA
- Colore**
bianco
- Temperatura colore**
4000K
- Driver**
incluso
- Material**
aluminum,
PMMA diffuser
- Colour**
white
- Colour temperature**
4000K
- Driver**
included

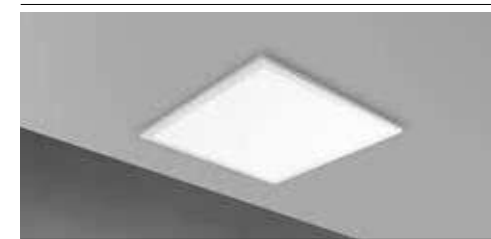

LED-PANEL-60X60-SM
8031414897599

lumen

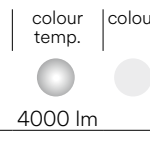

watt	30W
beam angle	120°
pf	0.90
□	590 × 590 mm

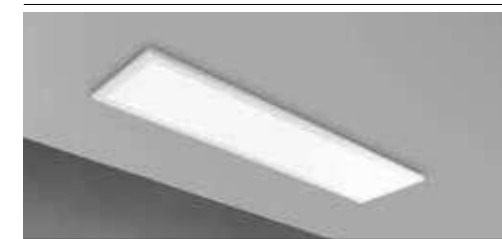
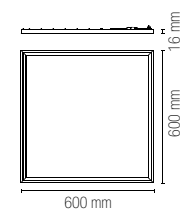

LED-PANEL-30X120-SM
8031414897605

lumen

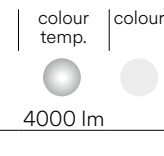

watt	30W
beam angle	120°
pf	0.90
□	290 × 1190 mm

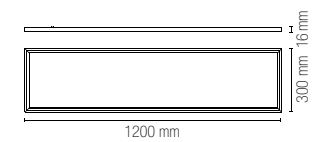

Fotometria del prodotto / Photometric curve

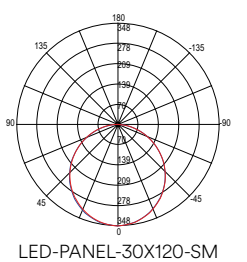
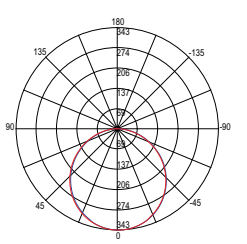

PANEL

Pannello a LED con struttura in alluminio e diffusore in acrilico bianco.
LED panel with aluminum structure, acrylic diffuser and white finish.

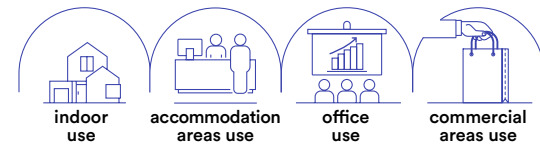

technical information **PANEL**



- Materiale**
alluminio,
diffusore in acrilico
- Colore**
bianco
- Temperatura colore**
4000K
- Driver**
incluso
- Material**
aluminum,
acrylic diffuser
- Colour**
white
- Colour temperature**
4000K
- Driver**
included

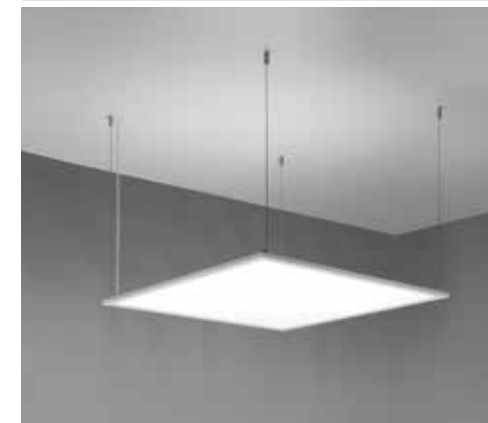

LED-PANEL-60X60-BIS
8031414865383

lumen	4000 lm (↓ 2000 lm + 2000 lm ↑)
watt	40W
beam angle	↓ 110° + 110° ↑
pf	0.90

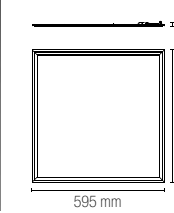

LED-PANEL-30X120-BIS
8031414865376

lumen	4000 lm (↓ 2000 lm + 2000 lm ↑)
watt	40W
beam angle	↓ 110° + 110° ↑
pf	0.90

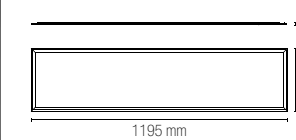

**Fotometria del prodotto /
Photometric curve**

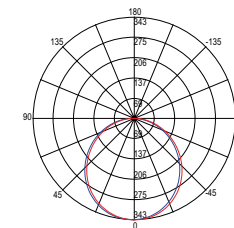

LED-PANEL-60X60-BIS

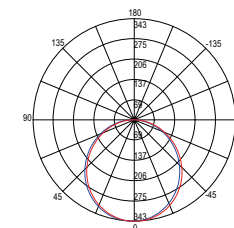







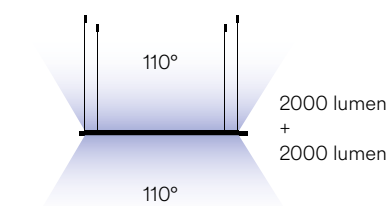

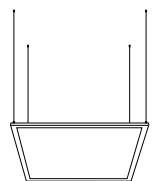

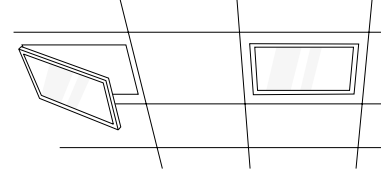



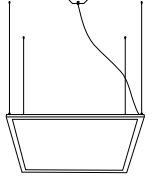





LED-PANEL-30X120-BIS

**Accessorio incluso /
Included accessory**

Kit cavi acciaio ed elettrico 1,5 m /
steel hanging cable and electric cable 1,5 m

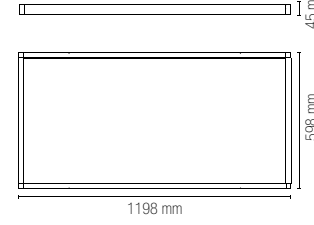

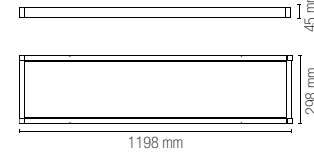
	LED-PANEL-KIT 8031440352451 Kit 6 cavi 150 cm in acciaio per sospensione.	Steel cable kit 150 cm for suspension.	
	LED-PANEL-GANCI 8031440361903 Kit molle 4pz.	Metal spring kit 4pcs.	
	LED-PANEL-STAFFE 8031414866175 Kit 6 staffe in acciaio per pannello LED.	Steel fixing bars for LED panel.	
	LED-PANEL-BASE 8031414866236 Base a soffitto per driver pannello LED misura: 160 x 110 x 35 mm	Metal canopy base for LED panel size: 160 x 110 x 35 mm	
	LED-PANEL-SOSP 8031440361781 Kit sospensione pannello cavo 1,5 m + scatola di connessione elettrica a soffitto misura: 120 x 120 x 60 mm	Kit for suspension with 1,5 m cable + metal canopy with electric connection size: 120 x 120 x 60 mm	
	LED-PANEL-DR 8031414889082 PANEL-DR Output 45W 1000mA 45VDC Input 230VAC misura: 141 x 38 x 28 mm	PANEL-DR Output 45W 1000mA 45VDC Input 230VAC size: 141 x 38 x 28 mm	
	LED-PANEL-DR-SLIM 8031414888412 PANEL-DR-SLIM Output 45W 1050mA 27-42V Input 220-240VAC misura: 265 x 23 x 20,5 mm	PANEL-DR-SLIM Output 45W 1050mA 27-42V Input 220-240VAC size: 265 x 23 x 20,5 mm	
	LED-PANEL-DR-SLIM-DIM 8031414888429 PANEL-DR-SLIM-DIM Output 45W 1050mA 27-42V Input 220-240VAC 0-10V DIMM misura: 265 x 23 x 22,3 mm	PANEL-DR-SLIM-DIM Output 45W 1050mA 27-42V Input 220-240VAC 0-10V DIMM size: 265 x 23 x 22,3 mm	

	LED-PANEL-60X60-MT 8031414866212 Struttura per pannello LED, finitura bianco gofrato	Aluminum frame for LED panel, embossed white	colour 	Misure dimensioni mm / Size mm 
	LED-PANEL-60X60-MT GR 8031414871452 Struttura per pannello LED, finitura grigio gofrato	Aluminum frame for LED panel, embossed grey	colour 	
	LED-PANEL-60X60-MT NER 8031414871469 Struttura per pannello LED, finitura nero gofrato	Aluminum frame for LED panel, embossed black	colour 	
	LED-PANEL-60X120-MT 8031414869176 Struttura per pannello LED, finitura bianco gofrato	Aluminum frame for LED panel, embossed white	colour 	Misure dimensioni mm / Size mm 
	LED-PANEL-30X120-MT 8031414866199 Struttura per pannello LED, finitura bianco gofrato	Aluminum frame for LED panel, embossed white	colour 	Misure dimensioni mm / Size mm 
	LED-PANEL-30X120-MT GR 8031414871506 Struttura per pannello LED, finitura grigio gofrato	Aluminum frame for LED panel, embossed grey	colour 	
	LED-PANEL-30X120-MT NER 8031414871476 Struttura per pannello LED, finitura nero gofrato	Aluminum frame for LED panel, embossed black	colour 	

PANEL-DJ

Pannello a LED con struttura in alluminio e diffusore in acrilico. Sistema di variazione gradi Kelvin e di intensità regolabili con radiocomando incluso e speaker bluetooth.
LED panel with aluminum structure, acrylic diffuser and white finish. Adjustable Kelvin and luminous flux with radio frequency remote control included and speaker bluetooth.

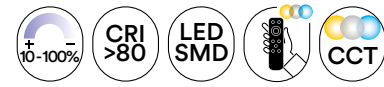
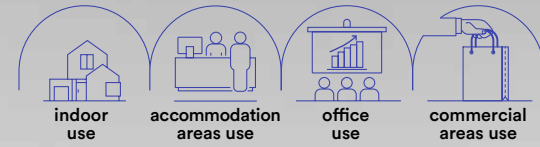

technical information **PANEL-DJ**



LED-PANEL-60X60-DJ 8031414876242	colour temp.	colour
lumen	CCT 1840 lm	
watt	42W	
beam angle	120°	

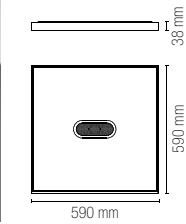

SPEAKER
2x5W connessione bluetooth 4.2 max 10 m /
2x5W bluetooth 4.2 connection max 10 m



LED-PANEL-30X60-DJ 8031414876259	colour temp.	colour
lumen	CCT 3360 lm	
watt	23W	
beam angle	120°	

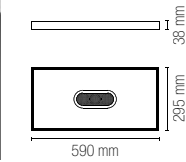

SPEAKER
2x5W connessione bluetooth 4.2 max 10 m /
2x5W bluetooth 4.2 connection max 10 m

Materiale
alluminio,
diffusore in acrilico

Colore
bianco



Temperatura colore
CCT



Driver
incluso

Dimmer
dimmerabile
con radiocomando
incluso

Material
aluminum,
acrylic diffuser

Colour
white



Colour temperature
CCT



Driver
included

Dimmer
dimmable with radio
frequency remote control
included

Fotometria del prodotto / Photometric curve

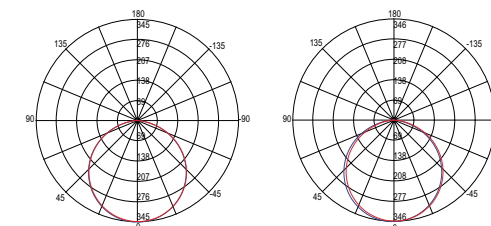

LED-PANEL-60X60-DJ

LED-PANEL-30X60-DJ

Accessorio incluso / Included accessory



Radiocomando / Remote control

Dimmerabile con radiocomando /
Dimmable with radio frequency remote control

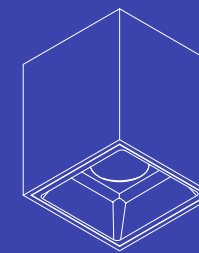

APPLIQUE E PLAFONIERE

WALL LAMPS AND CEILING LAMPS

KLIO

Plafoniera a LED con struttura in alluminio pressofuso e diffusore in acrilico.
LED ceiling lamp with die-cast aluminum structure and acrylic diffuser.

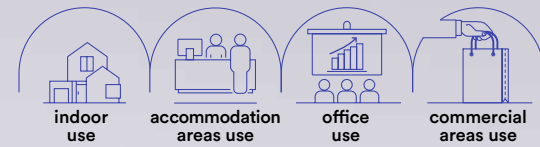

indoor use

accommodation areas use

office use

commercial areas use



Materiale
alluminio,
diffusore in acrilico

Colore
bianco gofrato
nero gofrato



Temperatura colore
3000K / 4000K



Driver
incluso

Material
aluminum,
acrylic diffuser

Colour
embossed white
embossed black



Colour temperature
3000K / 4000K



Driver
included

collection KLIO



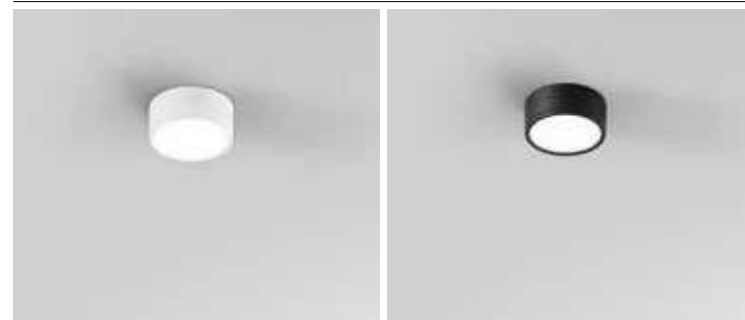
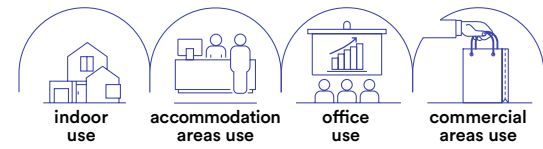

LED-KLIO-R11C 8031414875719	colour temp.	colour	 114 mm 49 mm
lumen	2000 lm		
LED-KLIO-R11 8031440358675			 Ø 114 mm
lumen	2000 lm		
LED-KLIO-R11 NER 8031414868032			
lumen	2000 lm		
watt		16W	
beam angle		120°	
pf		-	



LED-KLIO-R17C 8031414875726	colour temp.	colour	 Ø 168 mm 50 mm
lumen	3000 lm		
LED-KLIO-R17 8031440363587			 Ø 168 mm
lumen	3000 lm		
LED-KLIO-R17 NER 8031414868049			
lumen	3000 lm		
watt		22W	
beam angle		120°	
pf		-	



LED-KLIO-R21C 8031414875733	colour temp.	colour	 212 mm 50 mm
lumen	4600 lm		
LED-KLIO-R21 8031440363594			 Ø 212 mm
lumen	4600 lm		
LED-KLIO-R21 NER 8031414868056			
lumen	4600 lm		
watt		36W	
beam angle		120°	
pf		0.90	



LED-KLIO-R40C 8031414875740	colour temp.	colour	 400 mm 52 mm
lumen	7800 lm		
LED-KLIO-R40 8031414868087			 Ø 400 mm
lumen	7800 lm		
LED-KLIO-R40 NER 8031414868094			
lumen	7800 lm		
watt		64,8W	
beam angle		120°	
pf		0.90	

Fotometria del prodotto / Photometric curve

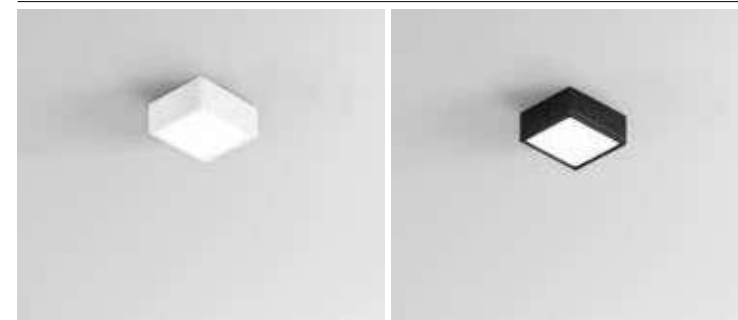
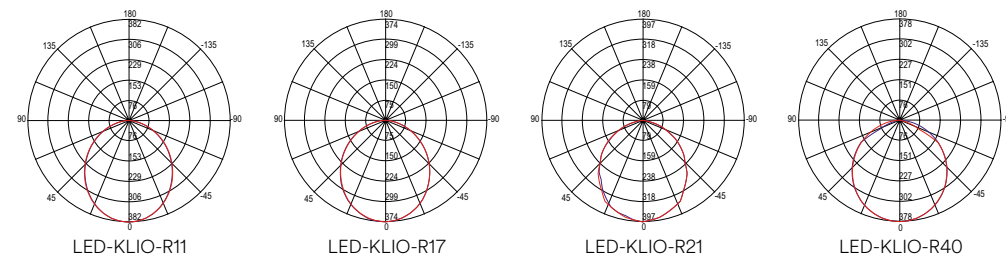

LED-KLIO-Q11C 8031414875672	colour temp.	colour	 112 mm 49 mm
lumen	2000 lm		
LED-KLIO-Q11 8031440363563			 112 mm
lumen	2000 lm		
LED-KLIO-Q11 NER 8031414868001			
lumen	2000 lm		
watt		16W	
beam angle		120°	
pf		-	

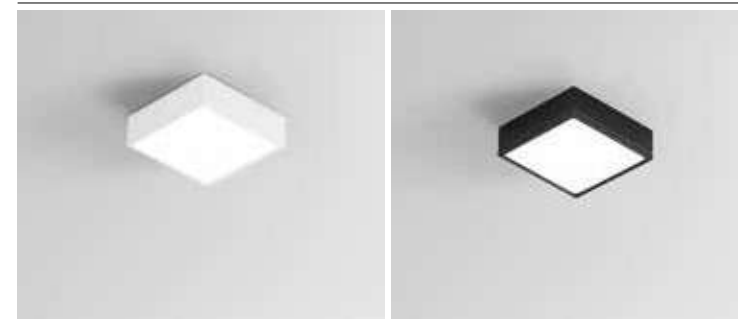

LED-KLIO-Q17C 8031414875689	colour temp.	colour	 167 mm 50,5 mm
lumen	3000 lm		
LED-KLIO-Q17 8031440363570			 167 mm
lumen	3000 lm		
LED-KLIO-Q17 NER 8031414868018			
lumen	3000 lm		
watt		22W	
beam angle		120°	
pf		-	

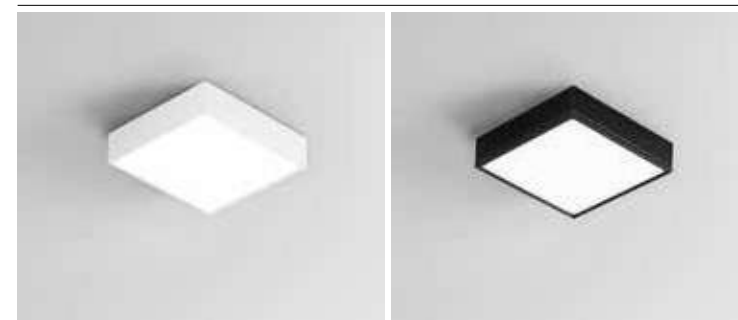

LED-KLIO-Q21C 8031414875696	colour temp.	colour	 211 mm 50,5 mm
lumen	4600 lm		
LED-KLIO-Q21 8031440363549			 211 mm
lumen	4600 lm		
LED-KLIO-Q21 NER 8031414868025			
lumen	4600 lm		
watt		36W	
beam angle		120°	
pf		0.90	

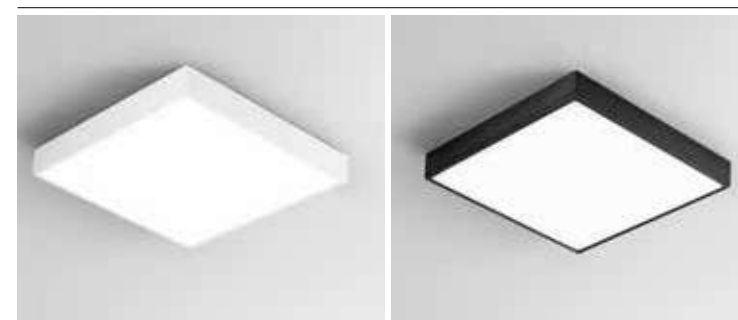

LED-KLIO-Q40C 8031414875702	colour temp.	colour	 400 mm 51 mm
lumen	7800 lm		
LED-KLIO-Q40 8031414868070			 400 mm
lumen	7800 lm		
LED-KLIO-Q40 NER 8031414868063			
lumen	7800 lm		
watt		64,8W	
beam angle		120°	
pf		0.90	

Fotometria del prodotto / Photometric curve

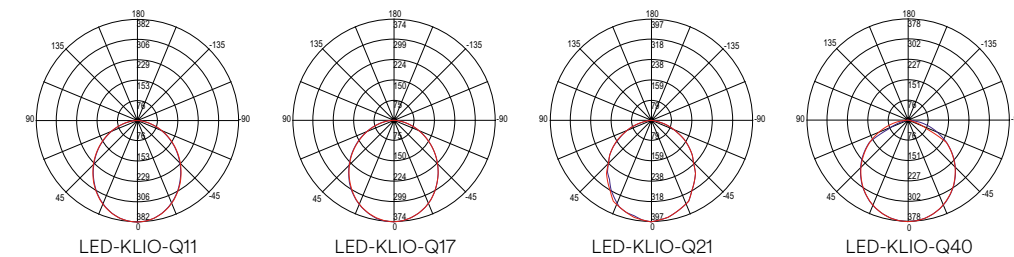

MIG

Plafoniera a LED anti-abbagliamento con struttura in alluminio.

Anti-glare LED ceiling lamp with aluminum structure.

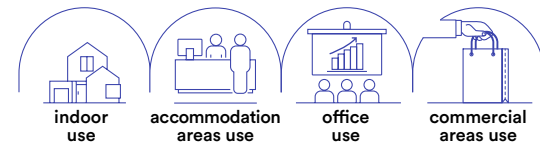

technical information **MIG**



Materiale
struttura in alluminio
riflettore in acrilico

Colore
bianco gofrato con
riflettore cromato,
nero gofrato con
riflettore nero lucido



Temperatura colore
3000K / 4000K



Driver
incluso

Durata e on/off
50.000 h >25.000 on/off

Material
aluminum structure
with acrylic reflector

Colour
embossed white
with chrome reflector,
embossed black with
glossy black reflector



Colour temperature
3000K / 4000K



Driver
included

Lifetime and on/off
50.000 h >25.000 on/off



	colour temp.	colour
LED-MIG-R20C BCO 8031414874064 lumen	2000 lm	
LED-MIG-R20 BCO 8031414866823 lumen	2000 lm	
LED-MIG-R20C NER 8031414874057 lumen	2000 lm	
LED-MIG-R20 NER 8031414866717 lumen	2000 lm	
watt	20W	
beam angle	45°	
pf	0.90	

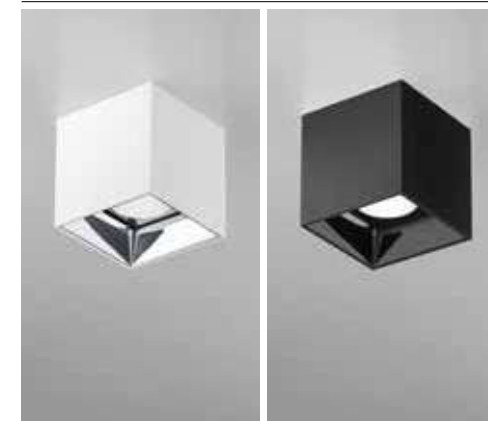
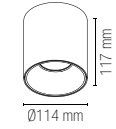

	colour temp.	colour
LED-MIG-Q20C BCO 8031414874118 lumen	2000 lm	
LED-MIG-Q20 BCO 8031414870981 lumen	2000 lm	
LED-MIG-Q20C NER 8031414874101 lumen	2000 lm	
LED-MIG-Q20 NER 8031414866731 lumen	2000 lm	
watt	20W	
beam angle	45°	
pf	0.90	

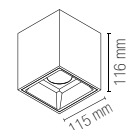

Fotometria del prodotto / Photometric curve

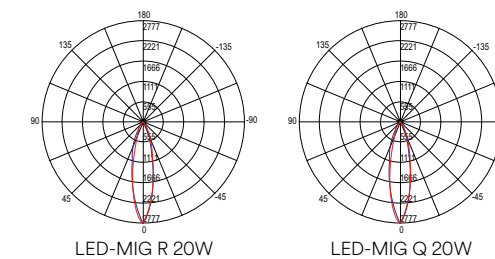

GENESIS

Plafoniera orientabile con struttura in alluminio bianco o nero opaco.
Adjustable ceiling lamp with aluminum structure in matt white and black.

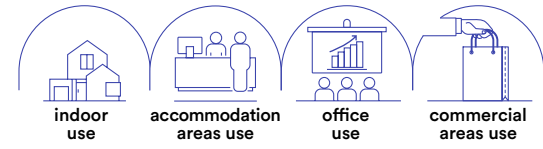

technical information **GENESIS**



I-GENESIS-R6-BCO
8031414883202



1 x GU10 MAX 35W

I-GENESIS-R6-NER
8031414883219



1 x GU10 MAX 35W

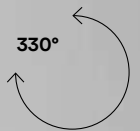
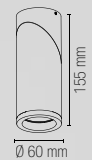

Lampadina non inclusa /
Light bulb not included

TOWN

Plafoniera con struttura in alluminio bianco o nero opaco.
Ceiling lamp with aluminum structure in matt white and black.

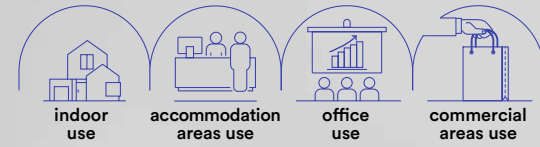

technical information **TOWN**

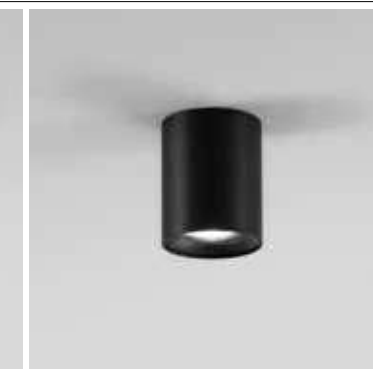

I-TOWN-R BCO
8031414868179
I-TOWN-R NER
8031414868162

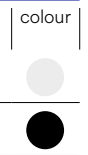

1 x GU10 MAX 35W

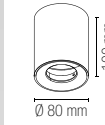

I-TOWN-Q BCO
8031414868155
I-TOWN-Q NER
8031414868148

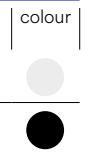

1 x GU10 MAX 35W

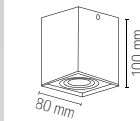

I-TOWN-R2 BCO
8031414883189
I-TOWN-R2 NER
8031414883196

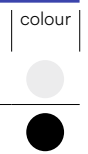

2 x GU10 MAX 35W

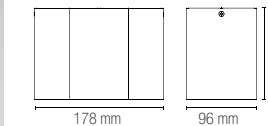

I-TOWN-Q2 BCO
8031414883165
I-TOWN-Q2 NER
8031414883172

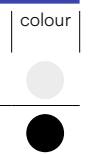

2 x GU10 MAX 35W

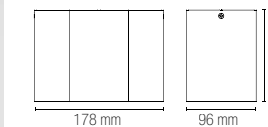

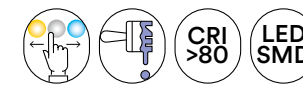
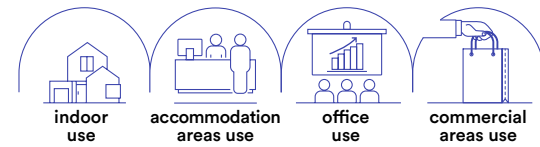

Plafoniera a LED in gesso verniciabile con interruttore per regolazione colore temperatura Kelvin.

LED ceiling lamp in paintable gypsum and switch for tempering adjustment Kelvin.



technical information **XICO**



- Materiale**
gesso verniciabile
con ghiere
nere lucide
- Temperatura colore
selezionabile**
2700K / 4000K / 6500K
- 
- Driver**
incluso
- Material**
paintable plaster with
glossy black metal
decorative rings
- Selectable color
temperature**
2700K / 4000K / 6500K
- 
- Driver**
included

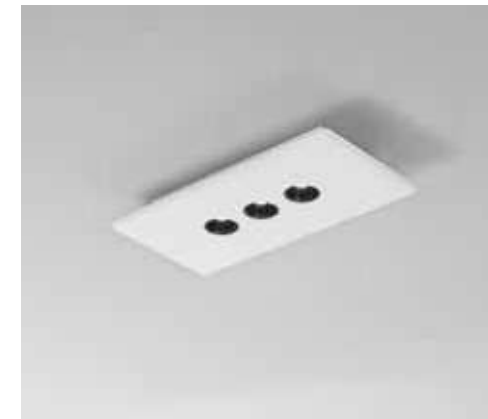

LED-XICO-40X20
8031414883677
lumen 840 lm

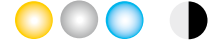
colour temp. 
840 lm

watt LED 3 x 4W
beam angle 36°

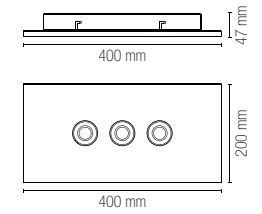

LED-XICO-70X20
8031414883660
lumen 1260 lm

colour temp. 
1260 lm

watt LED 6 x 3W
beam angle 36°

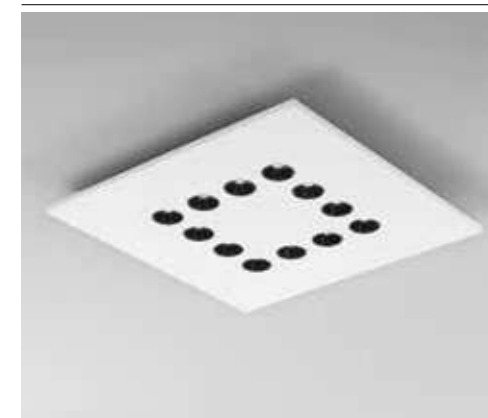
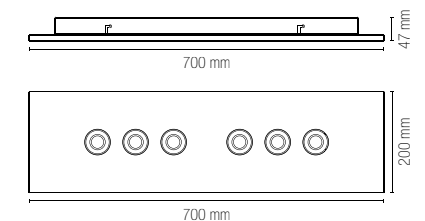

LED-XICO-50X50
8031414883653
lumen 2520 lm

colour temp. 
2520 lm

watt LED 12 x 3W
beam angle 36°

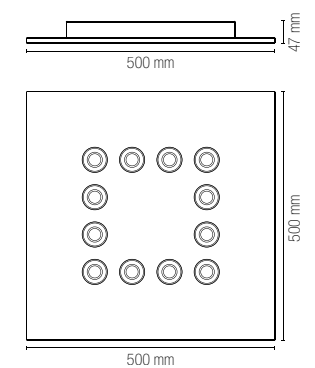

VORTEX

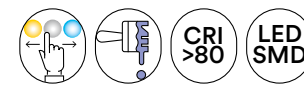
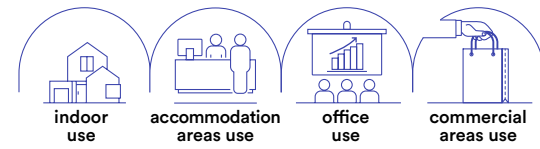

Plafoniera a LED in gesso verniciabile con interruttore per regolazione colore temperatura Kelvin.

LED ceiling lamp in paintable gypsum with switch for temperature adjustment Kelvin.



technical information **VORTEX**



- Materiale**
gesso verniciabile
- Temperatura colore selezionabile**
2700K / 4000K / 6500K
- 
- Driver**
incluso
- Material**
paintable plaster
- Selectable color temperature**
2700K / 4000K / 6500K
- 
- Driver**
included

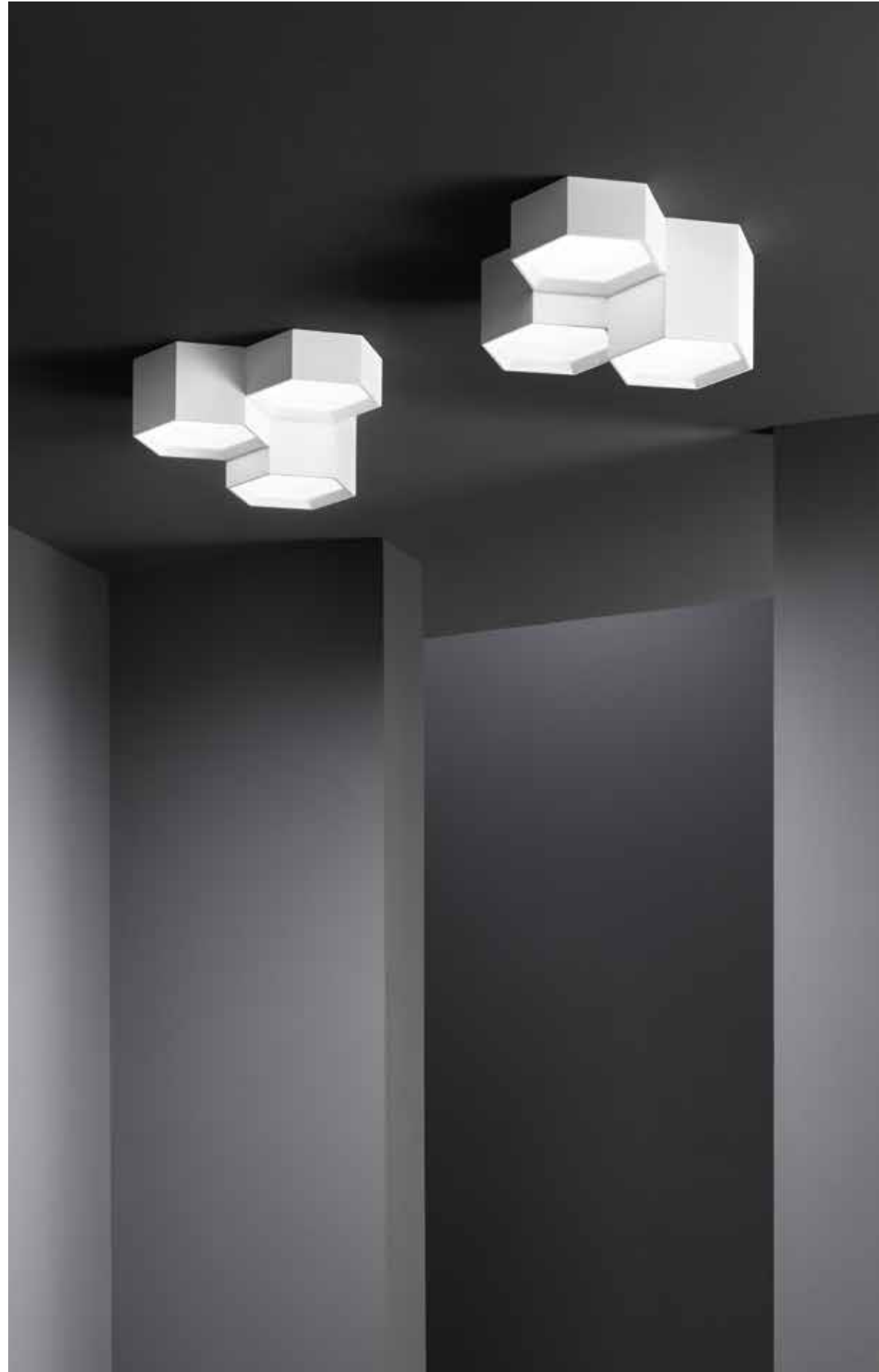

LED-VORTEX-PL1
8031414883691
lumen

colour temp.

1310 lm

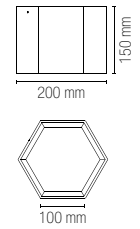
watt LED 12W
beam angle 120°
pf -



LED-VORTEX-PL3
8031414883684
lumen

colour temp.

3930 lm

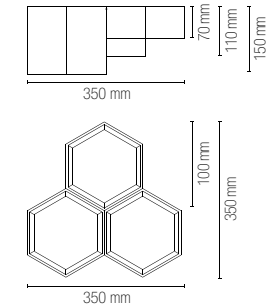
watt LED 36W
beam angle 120°
pf 0.90

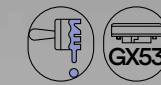
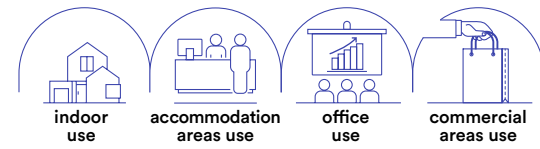

ATHEN

Plafoniera in gesso verniciabile con portalampade GX53.
Ceiling lamp in paintable gypsum with GX53 lamp holder.



technical information **ATHEN**



I-ATHEN-R1
8031414892945
1 x GX53 MAX 9W

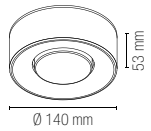

I-ATHEN-R2
8031414892679
2 x GX53 MAX 9W

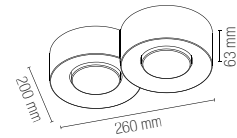

I-ATHEN-R3
8031414892686
3 x GX53 MAX 9W

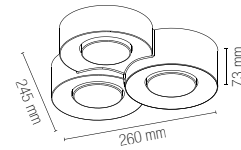

Lampadina non inclusa /
Light bulb not included



I-ATHEN-Q1
8031414892693
1 x GX53 MAX 9W

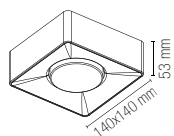

I-ATHEN-Q2
8031414892709
2 x GX53 MAX 9W

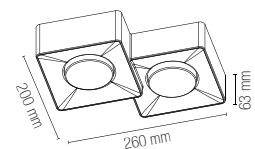

I-ATHEN-Q3
8031414892716
3 x GX53 MAX 9W

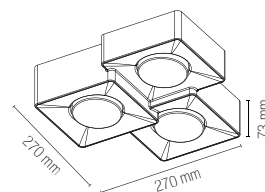

Lampadina non inclusa /
Light bulb not included



SPACE

Plafoniera in gesso verniciabile con ghiera orientabile.
LED ceiling lamp in paintable gypsum with adjustable ring.

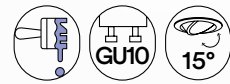

I-SPACE-R1
8031434141214

I-SPACE-Q1
8031434171211

1 x GU10 MAX 35W

1 x GU10 MAX 35W

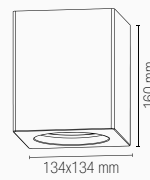
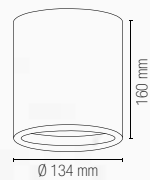

Lampadina non inclusa /
Light bulb not included

Plafoniera struttura in gesso verniciabile.
Gypsum ceiling lamp paintable.

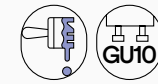
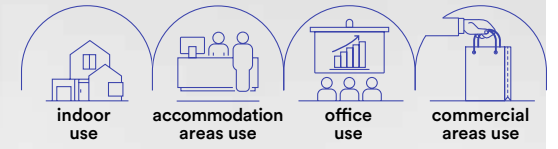

I-SPACE-S-R1
8031439531263

I-SPACE-S-Q1
8031439521264

1 x GU10 MAX 9W

1 x GU10 MAX 9W

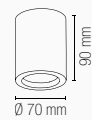

Lampadina non inclusa /
Light bulb not included

BANJIE

Applique a parete o plafoniera
con struttura in gesso verniciabile.

Gypsum ceiling and
wall lamps paintable.

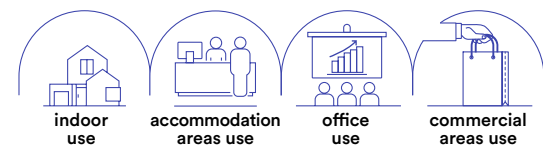

collection **BANJIE**



In.tec light APPLIQUE E PLAFONIERE / WALL LAMPS AND CEILING LAMPS

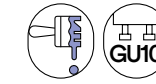

I-BANJIE-S-AP
8031440365475

2 x GU10 MAX 9W

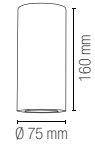

Lampadina non inclusa /
Light bulb not included



I-BANJIE-L-AP
8031440365499

2 x GU10 MAX 9W

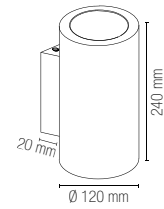

Lampadina non inclusa /
Light bulb not included



I-BANJIE-AP4
8031414866533

4 x GU10 MAX 9W

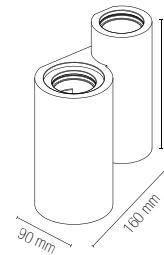

Lampadina non inclusa /
Light bulb not included



I-BANJIE-PL1
8031414867479

1 x GU10 MAX 35W

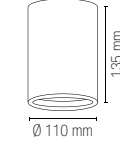

Lampadina non inclusa /
Light bulb not included



I-BANJIE-PL3
8031414867486

3 x GU10 MAX 9W

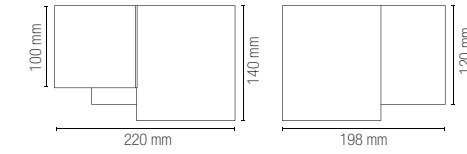

Lampadina non inclusa /
Light bulb not included



I-BANJIE-PL5
8031414867493

5 x GU10 MAX 9W

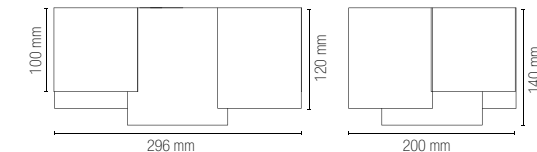

Lampadina non inclusa /
Light bulb not included

FOSTER

Applique a parete o plafoniera
con struttura in gesso verniciabile.

Gypsum ceiling and
wall lamps paintable.

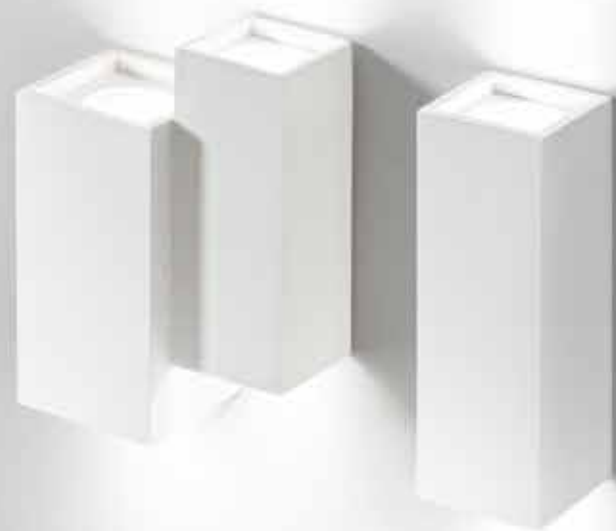
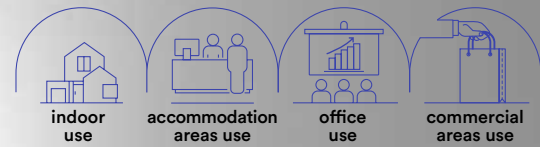

collection FOSTER

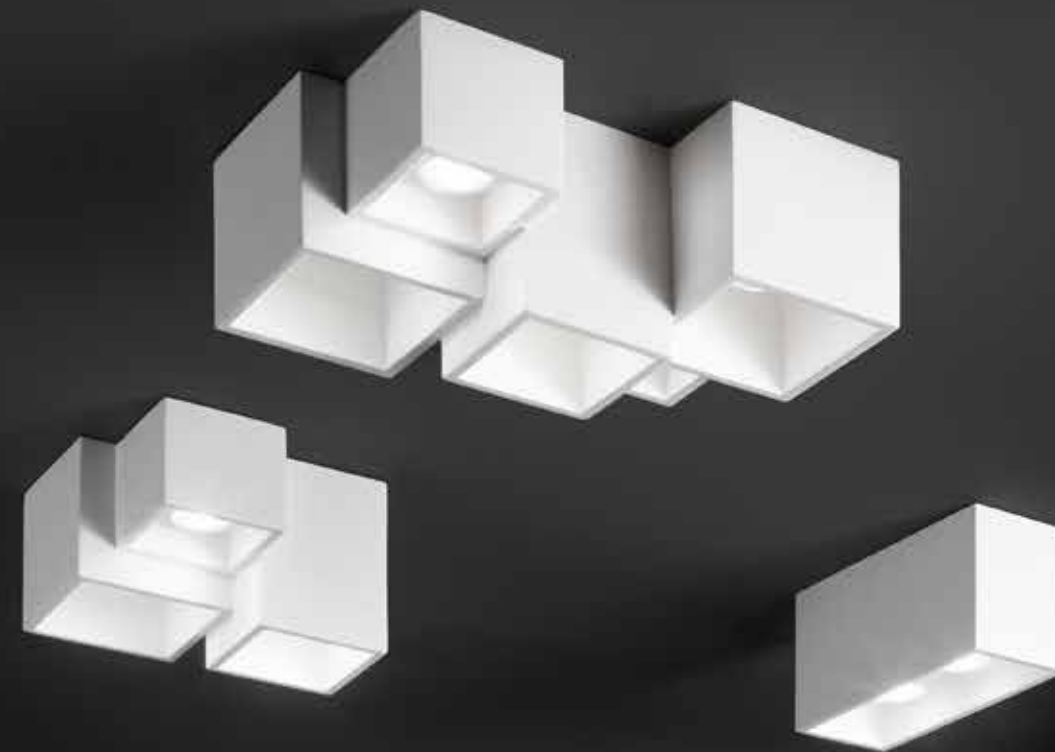

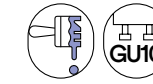

I-FOSTER-AP
8031414861385

2 x GU10 MAX 9W

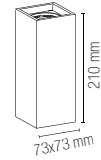

Lampadina non inclusa /
Light bulb not included



I-FOSTER-AP4
8031414867509

4 x GU10 MAX 9W

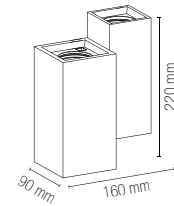

Lampadina non inclusa /
Light bulb not included



I-FOSTER-PL1
8031414867516

1 x GU10 MAX 35W

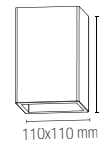

Lampadina non inclusa /
Light bulb not included



I-FOSTER-PL25
8031414876013

2 x GU10 MAX 35W



Lampadina non inclusa /
Light bulb not included



I-FOSTER-PL3
8031414867523

3 x GU10 MAX 9W

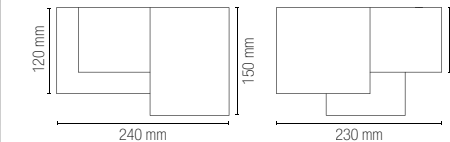

Lampadina non inclusa /
Light bulb not included



I-FOSTER-PL5
8031414867530

5 x GU10 MAX 9W

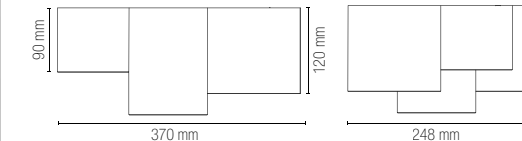

Lampadina non inclusa /
Light bulb not included

HAPIS

Plafoniere con struttura in gesso verniciabile.
Paintable gypsum ceiling lamps.

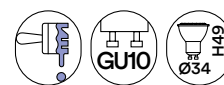
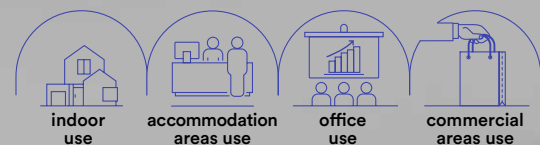

technical information **HAPIS**



I-HAPIS-Q4
8031414884308

4 x GU10 MINI MAX 35W



Lampadina non inclusa /
Light bulb not included



I-HAPIS-RT4
8031414884285

4 x GU10 MINI MAX 35W

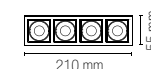

Lampadina non inclusa /
Light bulb not included



I-HAPIS-RT8
8031414884292

8 x GU10 MINI MAX 35W

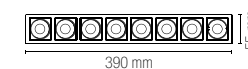
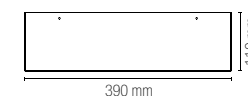

Lampadina non inclusa /
Light bulb not included

LIVING

Plafoniere in gesso verniciabile con diffusore in acrilico.
Paintable gypsum ceiling lamps with acrylic diffuser.

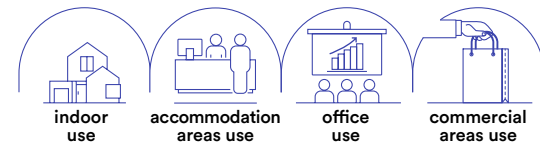

technical information **LIVING**



I-LIVING-PL14
8031414876020

1 x E27 MAX 15W

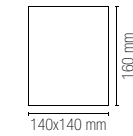

Lampadina non inclusa /
Light bulb not included



I-LIVING-PL11
8031414876037

1 x E14 MAX 13W

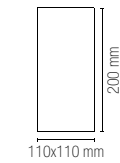

Lampadina non inclusa /
Light bulb not included



I-LIVING-PL23
8031414876044

2 x E14 MAX 13W

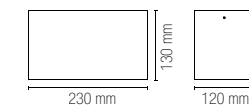

Lampadina non inclusa /
Light bulb not included



I-LIVING-PL36
8031414876051

4 x E14 MAX 13W

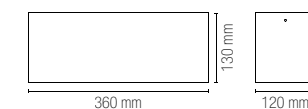

Lampadina non inclusa /
Light bulb not included

GABRIEL

Plafoniere in gesso verniciabile con diffusore in vetro.
Ceiling lamps in paintable gypsum with glass diffuser.

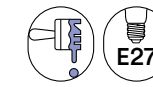
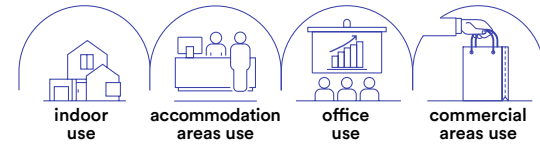

technical information **GABRIEL**



I-GABRIEL/PL30R
8031434111217

2 x E27 MAX 25W

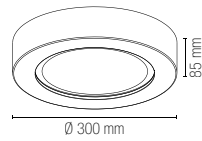

Lampadina non inclusa /
Light bulb not included



I-GABRIEL/PL25Q
8031434101218

2 x E27 MAX 25W

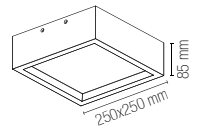

Lampadina non inclusa /
Light bulb not included



In.tec light APPLIQUE E PLAFONIERE / WALL LAMPS AND CEILING LAMPS

ROCK

Plafoniera in gesso verniciabile o cemento naturale con LED integrato.
Gypsum paintable or natural concrete ceiling lamp with built-in LED.

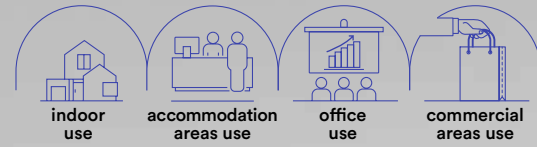

technical information **ROCK**



LED-ROCK-Q 8031414867660 lumen	colour temp.	colour
	2000 lm	
watt	25W	
beam angle	120°	

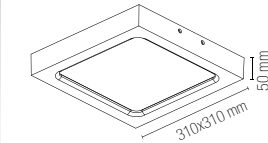

LED-ROCK-CM-Q 8031414867646 lumen	colour temp.	colour
	2000 lm	
watt	25W	
beam angle	120°	

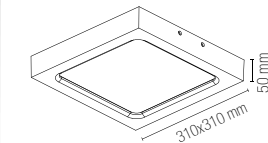

Materiale
gesso verniciabile
cemento naturale

Temperatura colore
4000K



Driver
incluso

Material
paintable plaster
natural concrete

Colour temperature
4000K



Driver
included

ALOHA

Applique a parete in gesso verniciabile.
Gypsum wall lamp paintable.

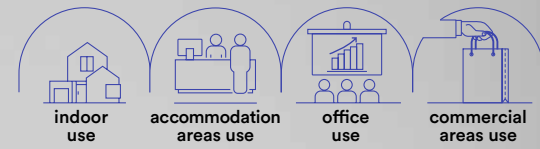

technical information **ALOHA**



Materiale
gesso verniciabile

Temperatura colore selezionabile
3000K / 4000K



Driver
incluso

Material
paintable plaster

Selectable color temperature
3000K / 4000K



Driver
included



LED-ALOHA-AP35
8031414892594
lumen

colour temp.
740 lm

watt 7W
beam angle 120°

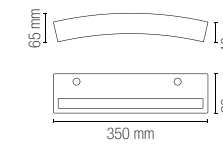

LED-ALOHA-AP55
8031414892600
lumen

colour temp.
1400 lm

watt 12W
beam angle 120°

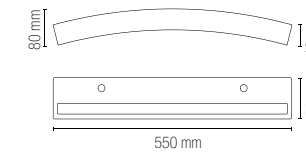

LED-ALOHA-AP80
8031414892617
lumen

colour temp.
2300 lm

watt 20W
beam angle 120°

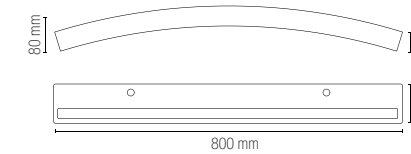

ORTISEI

Applique a parete in gesso verniciabile e doppia biemissione.
Gypsum wall lamp paintable and double light emission.

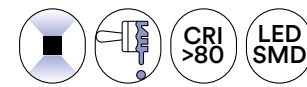
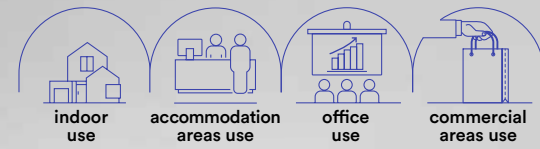

technical information **ORTISEI**



Materiale
gesso verniciabile

Temperatura colore
4000K

Temperatura colore selezionabile
3000K / 4000K

Driver
incluso

Material
paintable plaster

Colour temperature
4000K

Selectable color temperature
3000K / 4000K

Driver
included

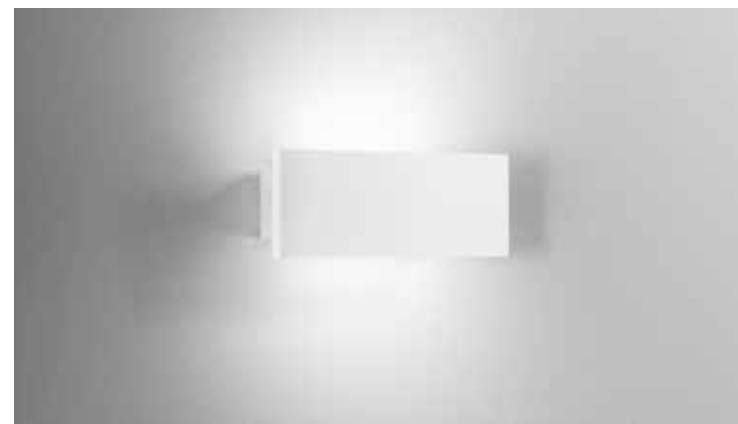

LED-ORTISEI-AP22
8031414866571
lumen 1080 lm

colour temp. 
1080 lm

watt 8W
beam angle ↓ 120° + 120° ↑

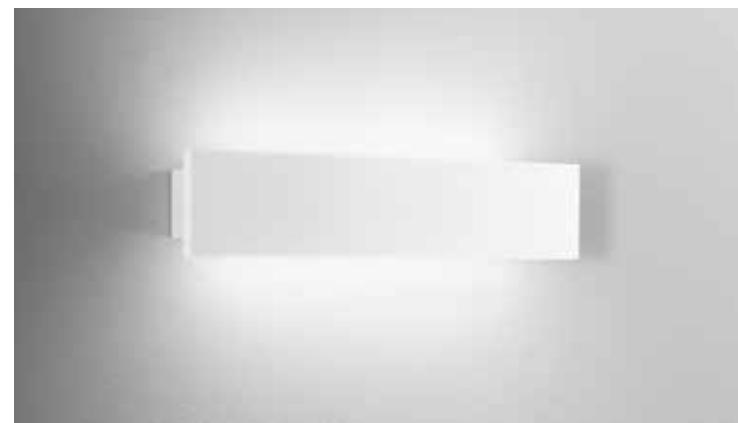

LED-ORTISEI-AP40
8031414866588
lumen 1400 lm

colour temp. 
1400 lm

watt 11,8W
beam angle ↓ 120° + 120° ↑

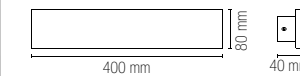

LED-ORTISEI-AP60
8031414866557
lumen 2200 lm

colour temp. 
2200 lm

watt 18W
beam angle ↓ 120° + 120° ↑

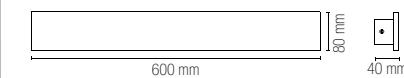

ROLLER

Applique a parete in gesso verniciabile con LED integrato.
Wall lamp in paintable gypsum with integrated LED.

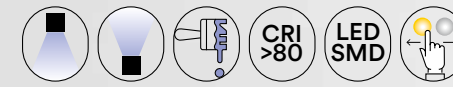
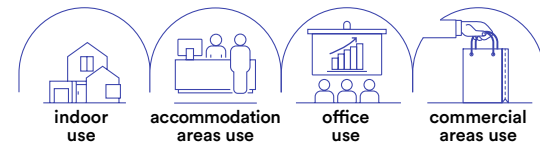

technical information **ROLLER**



Materiale
gesso verniciabile

Temperatura colore selezionabile
3000K / 4000K



Driver
incluso

Material
paintable plaster

Selectable color temperature
3000K / 4000K



Driver
included



LED-ROLLER-AP
8031414892624
lumen

colour temp.

700 lm

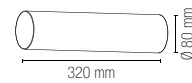
watt 7W
beam angle 120°

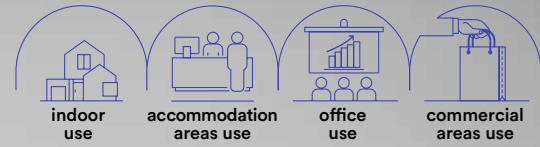

MOOD

Applique a parete in gesso verniciabile.
Wall lamp in paintable gypsum.



I-MOOD-AP
8031414882946

2 x G9 MAX 25W

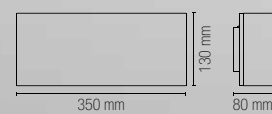

Lampadina non inclusa /
Light bulb not included

SOUL

Applique a parete in gesso verniciabile.
Wall lamp in paintable gypsum.

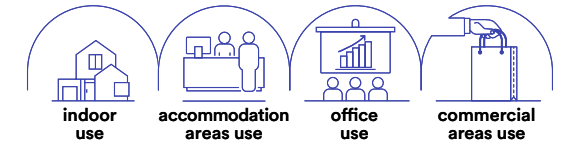

I-SOUL-AP
8031414882953

1 x E14 MAX 20W

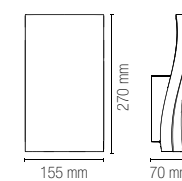

Lampadina non inclusa /
Light bulb not included

SPIRAL

Applique a parete in gesso verniciabile.
Wall lamp in paintable gypsum.

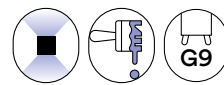
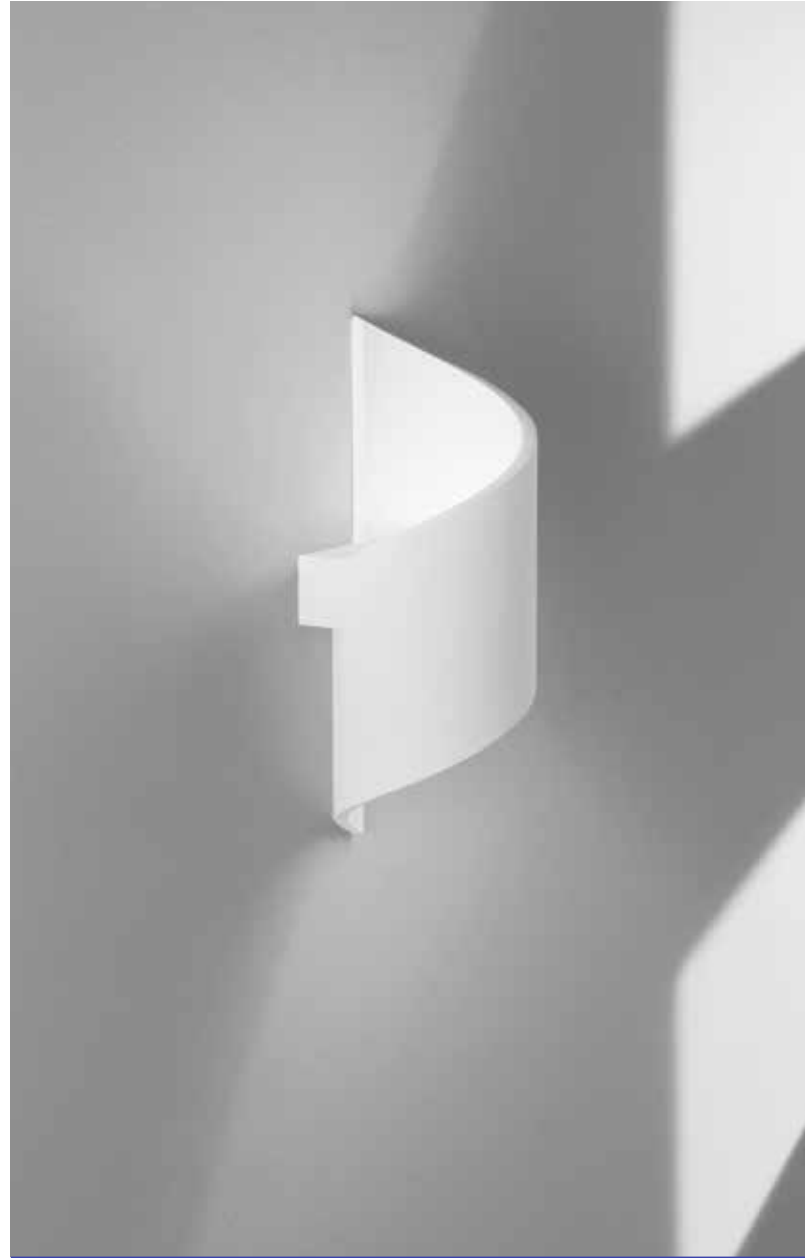
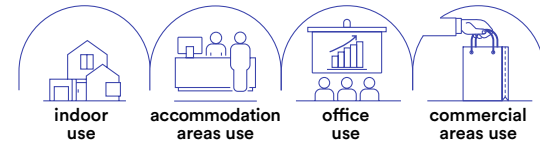

I-SPIRAL-AP
8031414892662

1 x G9 MAX 25W

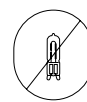
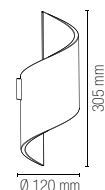

Lampadina non inclusa /
Light bulb not included



ORIGAMI

Applique a parete in gesso verniciabile.
Wall lamp in paintable gypsum.

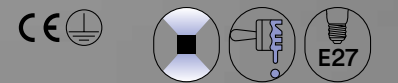
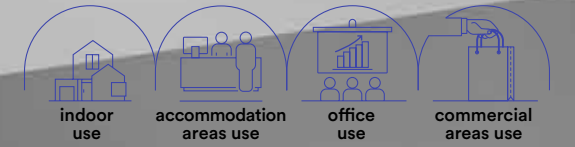

I-ORIGAMI-AP
8031414892938

1 x E27 MAX 20W

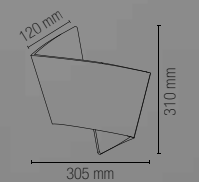

Lampadina non inclusa /
Light bulb not included



LEIRON

Applique a parete in gesso verniciabile.
Wall lamp in paintable gypsum.

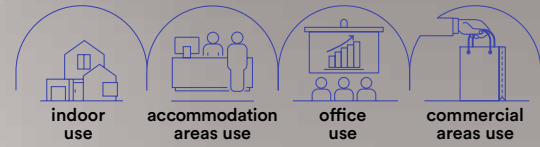

I-LEIRON-AP
8031436741238

1 x G9 MAX 25W

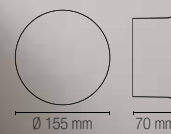

 Lampadina non inclusa /
Light bulb not included

MONTBLANC

Applique a parete in gesso verniciabile.
Wall lamp in paintable gypsum.

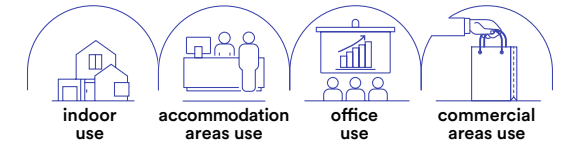

I-MONTBLANC-AP
8031414861354

1 x G9 MAX 25W

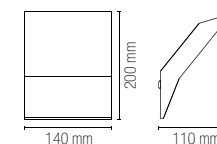

 Lampadina non inclusa /
Light bulb not included

CLEPSYDRA

Applique a parete in gesso verniciabile.
Wall lamp in paintable gypsum.

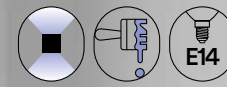
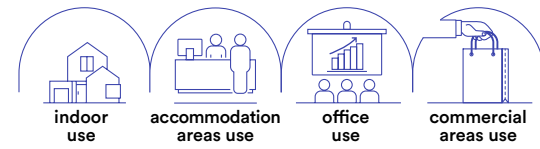

technical information **CLEPSYDRA**



I-CLEPSYDRA-M-AP
8031414892822

2 x E14 MAX 20W

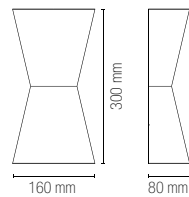

Lampadina non inclusa /
Light bulb not included



I-CLEPSYDRA-L-AP
8031414892839

2 x E14 MAX 20W

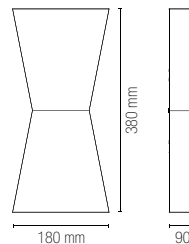

Lampadina non inclusa /
Light bulb not included



SHINE

Applique a parete in gesso verniciabile.
Wall lamp in paintable gypsum.

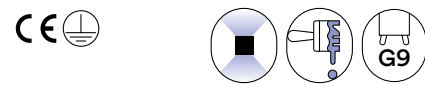
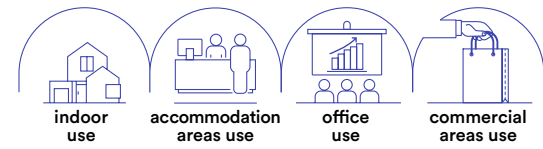

I-SHINE-AP
8031434191219

1 x G9 MAX 25W

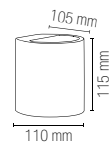

 Lampadina non inclusa /
Light bulb not included

ASTRON

Applique a parete in gesso verniciabile.
Wall lamp in paintable gypsum.

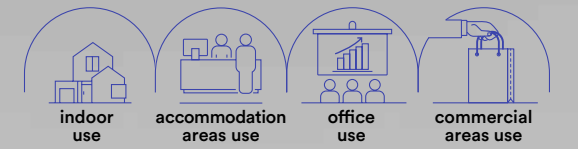

I-ASTRON-AP
8031414862412

1 x G9 MAX 25W

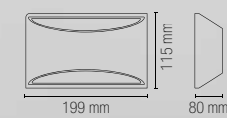

 Lampadina non inclusa /
Light bulb not included



APPLIQUE E PLAFONIERE / WALL LAMPS AND CEILING LAMPS

In.tec light

CERVINIA

Applique a parete in gesso verniciabile.
Wall lamp in paintable gypsum.

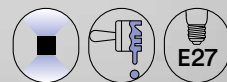
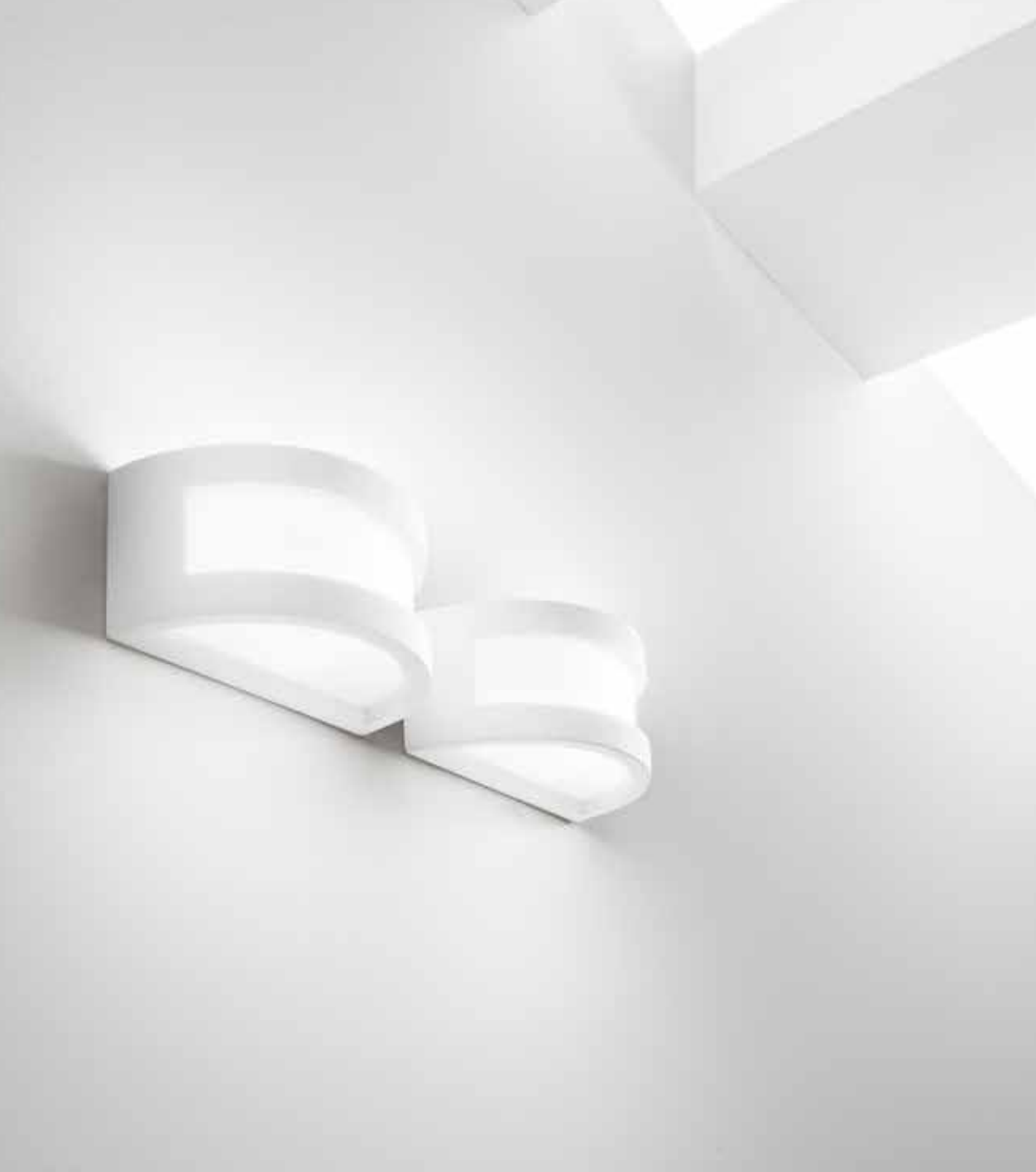
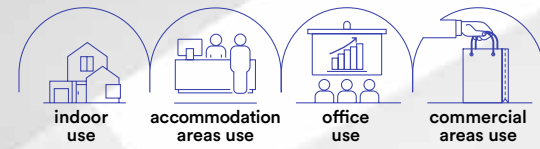

I-CERVINIA-AP
8031414873555

1 x E27 MAX 12W

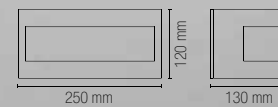

Lampadina non inclusa /
Light bulb not included

SCOTT

Applique a parete in gesso verniciabile.
Wall lamp in paintable gypsum.

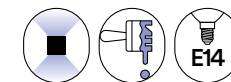
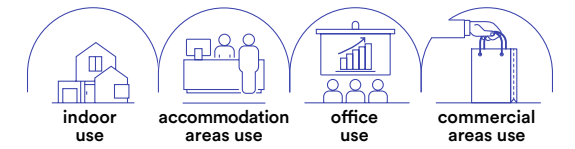

I-SCOTT-AP
8031414876082

2 x E14 MAX 20W

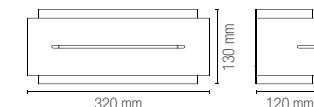

Lampadina non inclusa /
Light bulb not included

RUBIK

Applique a parete in gesso verniciabile.
Wall lamp in paintable gypsum.

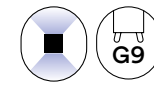
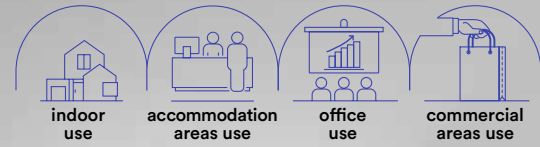

technical information RUBIK



I-RUBIK-AP2
8031414876075

2 x G9 MAX 25W

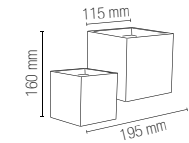

colour



Lampadina non inclusa /
Light bulb not included



I-RUBIK-AP
8031440362146

1 x G9 MAX 25W

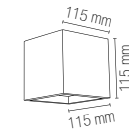

colour



Lampadina non inclusa /
Light bulb not included



I-RUBIK-CM-AP
8031414867608

1 x G9 MAX 25W

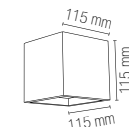

colour



Lampadina non inclusa /
Light bulb not included

MOSES

Applique a parete in gesso
verniciabile o cemento naturale.
Wall lamp in paintable
gypsum or natural cement.

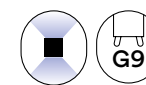
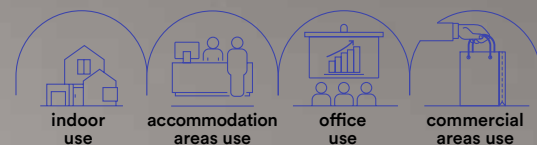

technical information **MOSES**



I-MOSES-AP
8031434181210

1 x G9 MAX 25W

colour



Lampadina non inclusa /
Light bulb not included

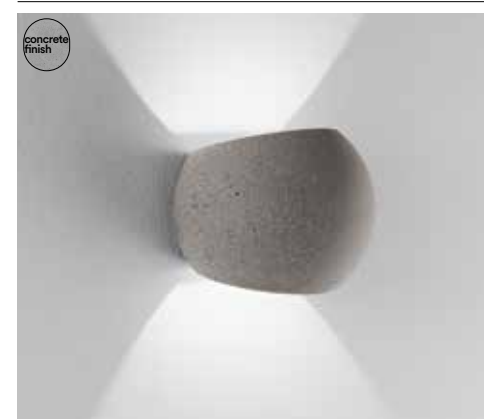
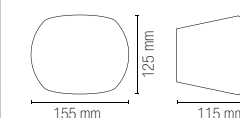

I-MOSES-CM-AP
8031414867615

1 x G9 MAX 25W

colour



Lampadina non inclusa /
Light bulb not included

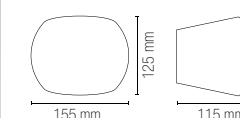

PIROETTE

Applique a parete in gesso verniciabile.
Wall lamp in paintable gypsum.

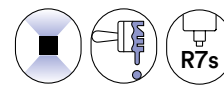
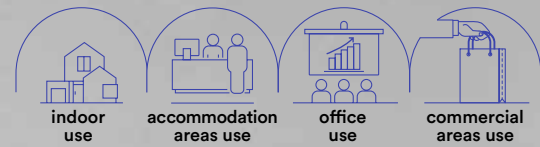

technical information **PIROETTE**

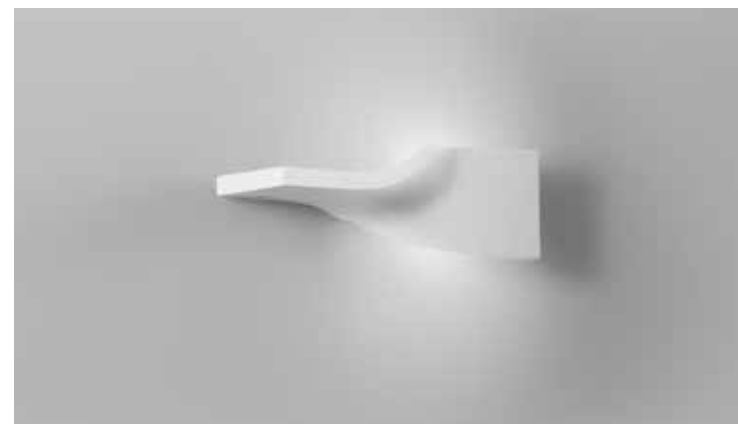

I-PIROETTE-AP36
8031414873562

1 x R7S MAX 7W



Lampadina
non inclusa /
Light bulb
not included

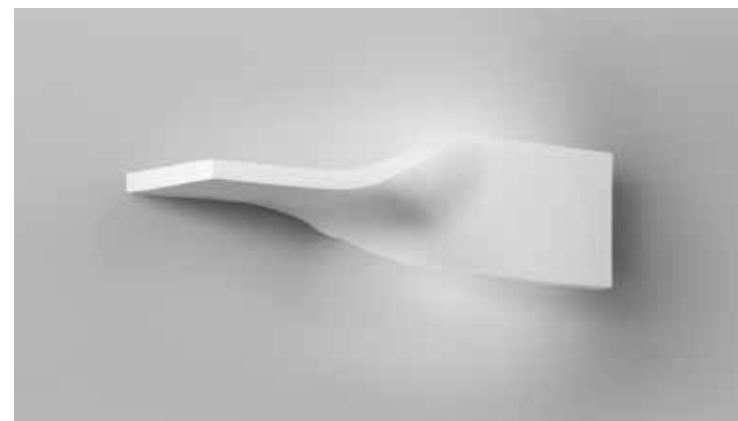
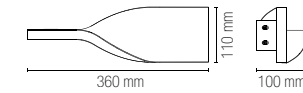

I-PIROETTE-AP56
8031414873579

1 x R7S MAX 20W



Lampadina
non inclusa /
Light bulb
not included

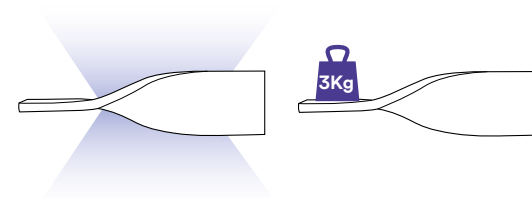
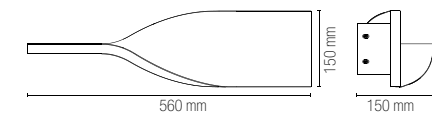

CORTINA

Applique a parete in gesso verniciabile,
diffusore inferiore in vetro satinato
e diffusore superiore in acrilico bianco.
Gypsum wall lamp paintable, lower diffuser
in satin glass and upper diffuser white acrylic.

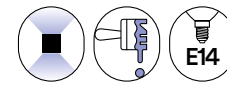
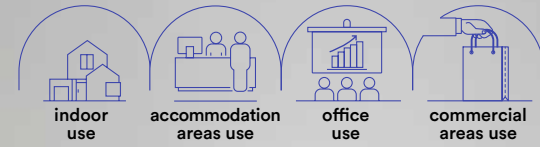

technical information **CORTINA**



I-CORTINA-S-AP
8031414866472
1 x E14 MAX 13W



Lampadina non inclusa /
Light bulb not included



I-CORTINA-AP
8031414861347
2 x E14 MAX 13W

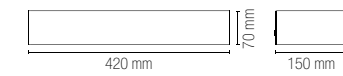

Lampadina non inclusa /
Light bulb not included

CANDIDA

Applique a parete in gesso verniciabile o cemento, diffusore inferiore in vetro satinato e diffusore superiore in acrilico bianco.

Gypsum wall lamp paintable or concrete, lower diffuser in satin glass and upper diffuser white acrylic.

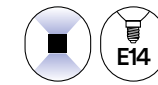
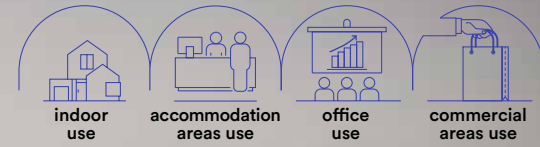

technical information **CANDIDA**



I-CANDIDA-S-AP
8031414866502

1 x E14 MAX 13W



colour



Lampadina non inclusa /
Light bulb not included



I-CANDIDA-AP
8031436751237

2 x E14 MAX 13W

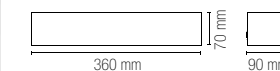

colour



Lampadina non inclusa /
Light bulb not included



I-CANDIDA-L-AP
8031414865567

2 x E14 MAX 13W

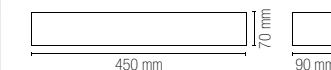

colour



Lampadina non inclusa /
Light bulb not included



I-CANDIDA-CM-AP
8031414867592

2 x E14 MAX 25W

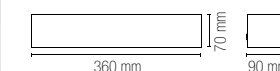

colour



Lampadina non inclusa /
Light bulb not included

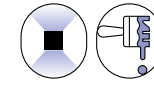
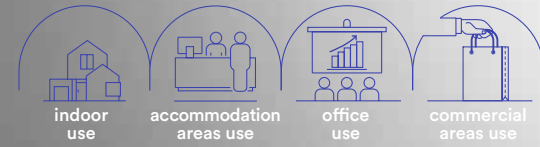

technical information **FLOW**



Applicque a parete in gesso verniciabile, diffusore inferiore in vetro satinato e diffusore superiore in acrilico bianco.
Wall lamp in paintable gypsum, lower diffuser in satin glass and upper diffuser white acrylic.



I-FLOW-AP29
8031414892655
1 x E27 MAX 20W

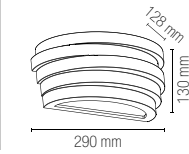

Lampadina non inclusa /
Light bulb not included



I-FLOW-AP37
8031414892648
2 x E14 MAX 20W

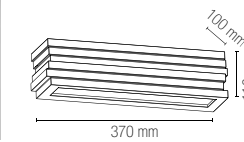

Lampadina non inclusa /
Light bulb not included

GATSBY

Applique a parete in gesso verniciabile,
diffusore inferiore in vetro satinato
e diffusore superiore in acrilico bianco.
Gypsum wall lamp paintable, lower diffuser
in satin glass and upper diffuser white acrylic.

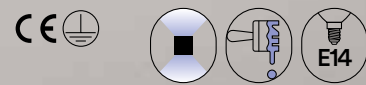
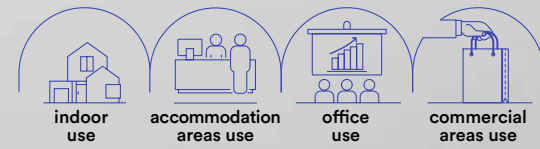

I-GATSBY-AP
8031414876068

2 x E14 MAX 20W



Lampadina non inclusa /
Light bulb not included

STONE

Applique a parete in gesso effetto sassi.
Wall lamp in stone effect gypsum.

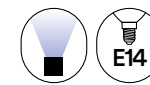
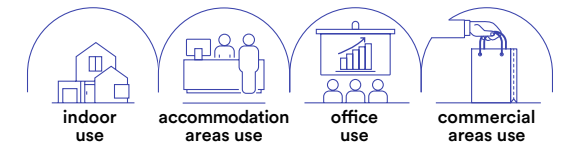

I-STONE-AP
8031414865291

1 x E14 MAX 13W

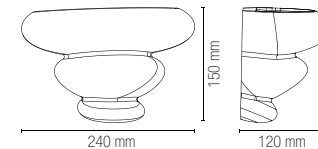

Lampadina non inclusa /
Light bulb not included

SANTORINI

Applique a parete angolare in gesso verniciabile.
Angular paintable gypsum.

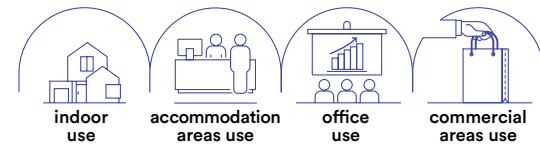

I-SANTORINI-AP
8031440351553

1 x E14 MAX 13W

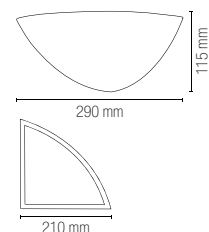

 Lampadina non inclusa /
Light bulb not included

MYKONOS

Applique a parete angolare in gesso
verniciabile con diffusore in vetro satinato.
Wall lamp in angular paintable gypsum
with satin glass diffuser.

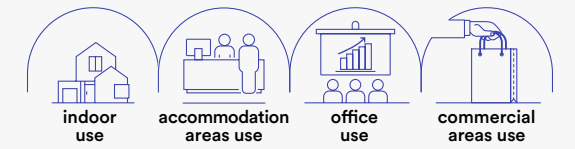

I-MYKONOS-AP
8031440351584

1 x E14 MAX 13W

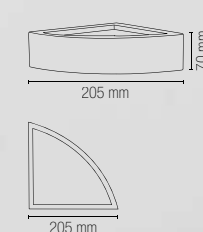

 Lampadina non inclusa /
Light bulb not included

SOLEIL

Applique in gesso verniciabile
con diffusore in vetro satinato.
Paintable gypsum wall lamp with
satin glass diffuser.

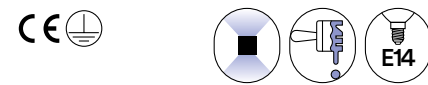
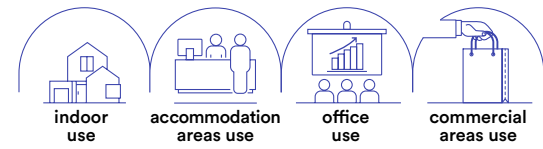

I-SOLEIL-AP
8031414892815

1 x E14 MAX 20W

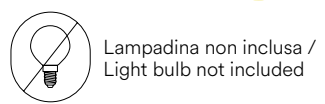
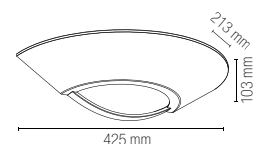

OLYMPIA

Applique a parete in gesso verniciabile.
Wall lamp in gypsum paintable.

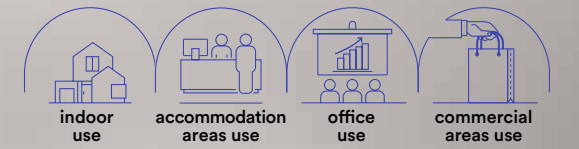

I-OLYMPIA-AP
8031414892631

1 x GU10 MAX 10W

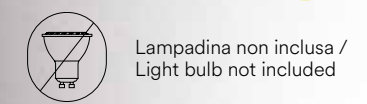
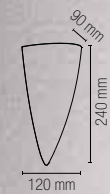

ABEL

Applique a parete in gesso verniciabile.
Wall lamp in paintable gypsum.

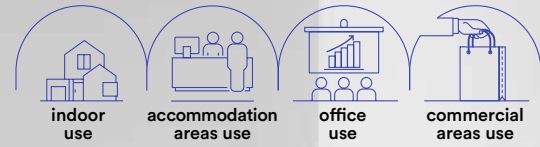

I-ABEL-AP
8031440362153

2 x E14 MAX 25W

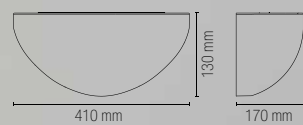

Lampadina non inclusa /
Light bulb not included

SESTRIERE

Applique a parete in gesso verniciabile.
Wall lamp in paintable gypsum.

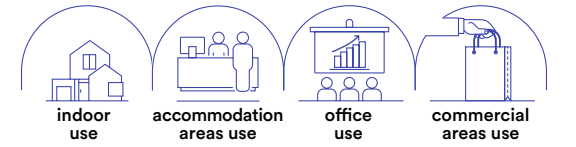

I-SESTRIERE-AP
8031414861330

1 x E27 MAX 40W

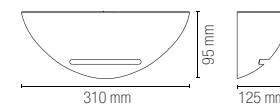

Lampadina non inclusa /
Light bulb not included

MORITZ

Applique a parete in gesso verniciabile
in foglia oro, foglia argento, effetto
legno noce o rovere sbiancato.
Wall lamp in paintable gypsum in gold
leaf, silver leaf, walnut or oak effect.

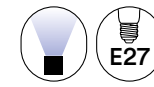
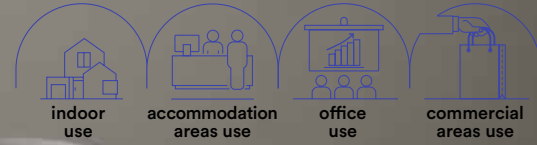

technical information **MORITZ**



Lampadina
non inclusa /
Light bulb
not included



I-MORITZ-L-AP
8031414861361

1 x E27 MAX 40W

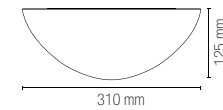

colour



I-MORITZ-S-AP
8031414861378

1 x E27 MAX 40W

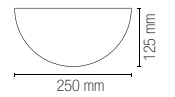

colour



I-MORITZ-S-SIL-AP
8031414866489

1 x E27 MAX 40W

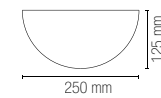

colour



I-MORITZ-S-ORO-AP
8031414866458

1 x E27 MAX 40W

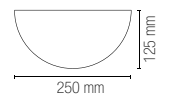

colour



I-MORITZ-S-BG-AP
8031414865338

1 x E27 MAX 40W

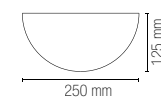

colour



I-MORITZ-S-NOC-AP
8031414865352

1 x E27 MAX 40W

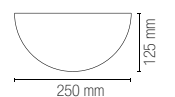

colour



LIVIGNO

Applique a parete in gesso verniciabile,
in foglia oro o foglia argento.
Wall lamp in paintable gypsum also
in gold leaf or silver leaf versions.

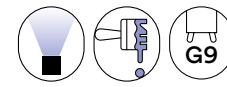
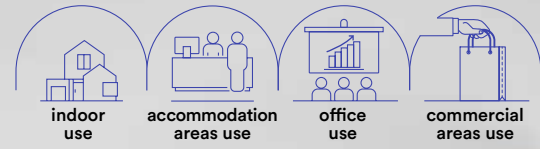

technical information **LIVIGNO**



I-LIVIGNO-AP
8031414867561

colour



2 x G9 MAX 25W

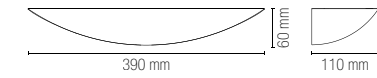

Lampadina non inclusa /
Light bulb not included



I-LIVIGNO-AP SIL
8031414867585

colour



2 x G9 MAX 25W

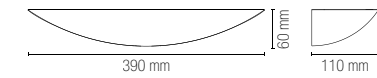

Lampadina non inclusa /
Light bulb not included



I-LIVIGNO-AP ORO
8031414867578

colour



2 x G9 MAX 25W

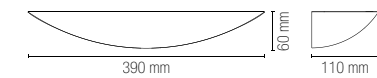

Lampadina non inclusa /
Light bulb not included

ALMA

Applique a parete in gesso bianco verniciabile, in foglia oro o foglia argento.
Wall lamp in white paintable gypsum, in gold or silver leaf.

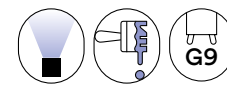
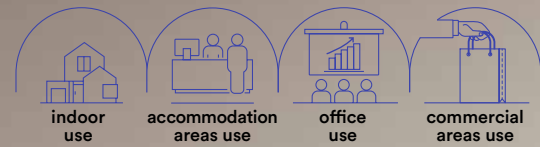

technical information **ALMA**



I-ALMA-AP
8031414866496

2 x G9 MAX 25W

colour

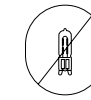
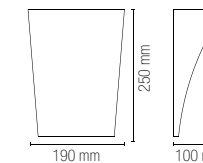

Lampadina non inclusa /
Light bulb not included



I-ALMA-AP SIL
8031414867554

2 x G9 MAX 25W

colour

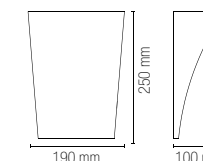

Lampadina non inclusa /
Light bulb not included



I-ALMA-AP ORO
8031414867547

2 x G9 MAX 25W

colour

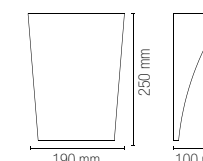

Lampadina non inclusa /
Light bulb not included

AILERON

Applique a LED orientabile in alluminio
bianco sabbato o bronzo sabbato.
Adjustable LED wall light in aluminum
in sandblasted white or sandblasted
bronze version.

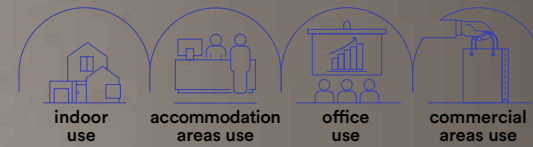

Materiale
alluminio

Colore
bianco sabbato
bronzo sabbato



Temperatura colore
4000K



Driver
incluso

Material
aluminum

Colour
sandblasted white
sandblasted bronze



Colour temperature
4000K



Driver
included



technical information **AILERON**



LED-W-AILERON BCO

8031414876938
lumen

colour temp.	colour

1300 lm

watt 10W
beam angle ↓ 120° + 120° ↑

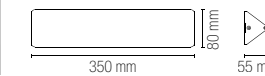

LED-W-AILERON BRO

8031414876945
lumen

colour temp.	colour

1300 lm

watt 10W
beam angle ↓ 120° + 120° ↑

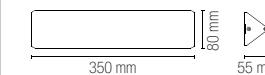

SIGMA

Applique a LED orientabile in metallo cromato con diffusore in acrilico.
Adjustable LED wall light in chromed metal with acrylic diffuser.

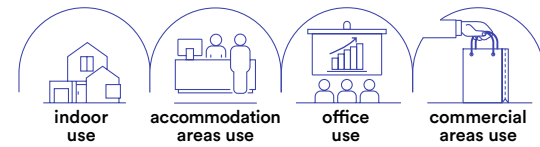

<p>Temperatura colore 3500K</p> <p>Driver incluso</p> <p>Colour temperature 3500K</p> <p>Driver included</p>		<p>LED-W-SIGMA/4W 8031432971202 lumen</p> <p>colour temp. colour 550 lm</p> <p>watt 4W beam angle 120°</p> <p>403 mm 120 mm 65 mm 215 mm</p>
--	--	---

CRI >80 LED SMD
CE EMC

ATLAS

Applique a LED in alluminio bianco goffrato.
White embossed aluminum LED wall light.

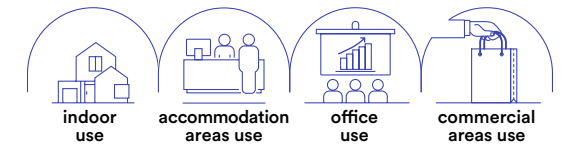

<p>Temperatura colore 3500K</p> <p>Driver incluso</p> <p>Colour temperature 3500K</p> <p>Driver included</p>		<p>LED-W-ATLAS/6W 8031433071208 lumen</p> <p>colour temp. colour 380 lm</p> <p>watt 6W beam angle ↓ 90° + 90° ↑</p> <p>80x80 mm 100 mm</p>
--	--	---

CRI >80 LED SMD
CE EMC

ANDROMEDA

Applique a LED orientabile in metallo cromato dalla linea sottile.
Adjustable LED wall light in chromed metal with a thin line.

<p>Temperatura colore 3500K</p> <p>Driver incluso</p> <p>Colour temperature 3500K</p> <p>Driver included</p>		<p>LED-W-ANDROMEDA/4W 8031432941205 lumen</p> <p>colour temp. colour 470 lm</p> <p>watt 4W beam angle 120°</p> <p>455 mm 45 mm 210 mm</p>
--	--	--

CRI >80 LED SMD
CE EMC

OMEGA

Applique a LED in alluminio bianco goffrato.
White embossed aluminum LED wall light.

<p>Temperatura colore 4000K</p> <p>Driver incluso</p> <p>Colour temperature 4000K</p> <p>Driver included</p>		<p>LED-W-OMEGA BCO 8031414875467 lumen</p> <p>colour temp. colour 800 lm</p> <p>watt 6W beam angle ↓ 90° + 90° ↑</p> <p>195 mm 37 mm 115 mm</p>
--	--	--

CRI >80 LED SMD
CE EMC

LAMBDA

Applique a LED in alluminio bianco goffrato.
Aluminum LED wall lamp embossed white.

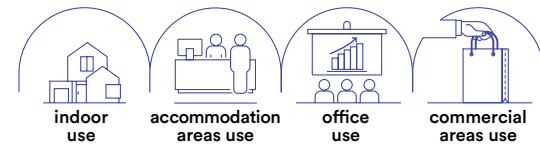

Materiale
alluminio

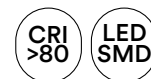

Temperatura colore

3500K



Driver
incluso

Material
aluminum

Colour temperature

3500K



Driver
included

	colour temp.	colour
LED-W-LAMBDA/4W 8031433001205 lumen	800 lm	

watt	6W
beam angle	↓ 90° + 90° ↑

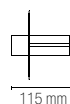
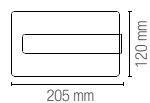

ALCOR

Applique a LED in alluminio dalla forma sottile in bianco goffrato o silver goffrato.
LED wall lamp in aluminum with a thin shape in embossed white or embossed silver.

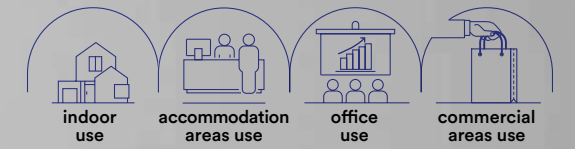

Materiale
alluminio

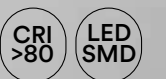

Temperatura colore

3000K



Driver
incluso

Material
aluminum

Colour temperature

3000K



Driver
included

	colour temp.	colour
LED-W-ALCOR/5W BCO 8031440355186 lumen	550 lm	

LED-W-ALCOR/5W SIL 8031440355148 lumen	550 lm	
---	--------	--

watt	5W
beam angle	120°

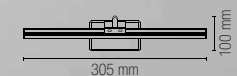

GRADO

Applique a LED in alluminio bianco goffrato.
Aluminum LED wall lamp embossed white.

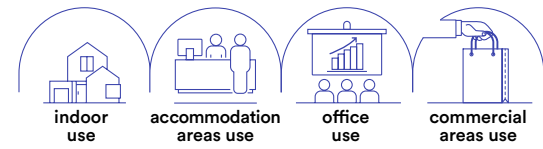

Materiale
alluminio



Temperatura colore

4000K



Driver
incluso

Material
aluminum

Colour temperature

4000K



Driver
included

	colour temp.	colour
LED-W-GRADO 8031440361194		
lumen	800 lm	
watt	10W	
beam angle	120°	

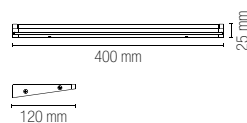

KITE

Applique a LED in alluminio bianco o nero laccato lucido.
LED wall lamp in white or glossy lacquered black aluminum.

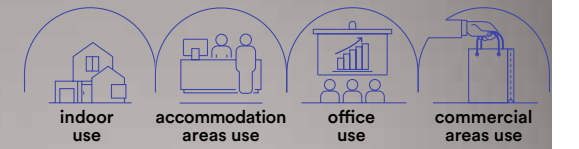

Materiale
alluminio

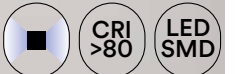

Temperatura colore

4000K



Driver
incluso

Material
aluminum

Colour temperature

4000K



Driver
included

	colour temp.	colour
LED-W-KITE BCO 8031440361170		
lumen	540 lm	
LED-W-KITE NERO 8031440361187		
lumen	540 lm	

watt	2 x 3W
beam angle	← 120° + 120° →

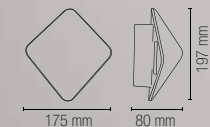

MUSTANG

Applique a LED in alluminio bianco goffrato.
Aluminum LED wall lamp embossed white.

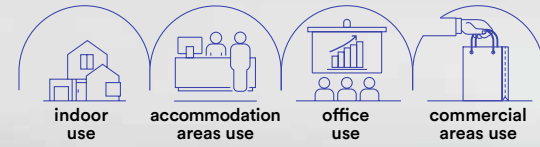

technical information **MUSTANG**



- Materiale**
alluminio
- Temperatura colore**
4000K
- Driver**
incluso
- Material**
aluminum
- Colour temperature**
4000K
- Driver**
included



	colour temp.	colour
LED-W-MUSTANG-200 8031440361156	<input checked="" type="radio"/>	<input type="radio"/>
lumen	780 lm	
watt	8W	
beam angle	120°	

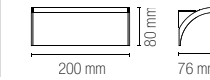

	colour temp.	colour
LED-W-MUSTANG-600 8031440361149	<input checked="" type="radio"/>	<input type="radio"/>
lumen	1860 lm	
watt	15W	
beam angle	120°	



TWILIGHT

Applique a LED In alluminio con diffusore orientabile in bianco gofrato.

Embossed white aluminum LED wall lamp with adjustable diffuser.

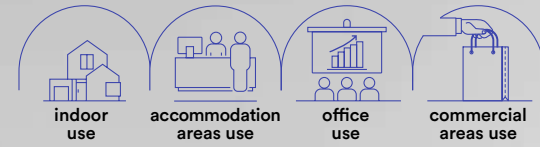

OMNIA

Applique orientabile con LED dimmerabile in alluminio bianco gofrato.

Adjustable wall lamp with dimmable LED in embossed white aluminum.

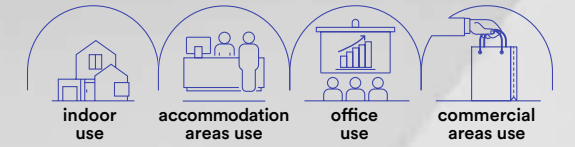

Materiale
alluminio

Temperatura colore
4000K



Driver
incluso

Material
aluminum

Colour temperature
4000K



Driver
included



Materiale
alluminio

Temperatura colore
3000K



Driver
incluso

Material
aluminum

Colour temperature
3000K



Driver
included

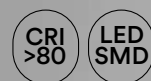

LED-W-TWILIGHT

8031440361088

lumen

colour temp. | colour

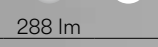

288 lm

watt | 4W
beam angle | 107°

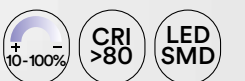
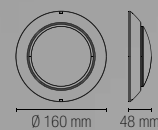

LED-W-OMNIA/15W

8031440351423

lumen

colour temp. | colour

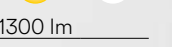

1300 lm

watt | 15W
beam angle | 107°

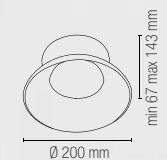

Plafoniere con ventilatore in bianco effetto cielo stellato.
Ceiling fan lamps with white starry sky effect.

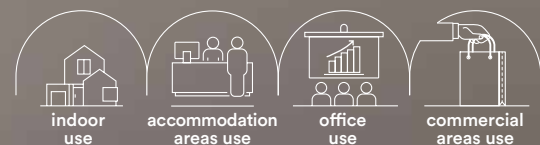

technical information



BOREA



LED-BOREA-INT
8031414873692

	colour temp.	colour
lumen	CCT 4450 lm	
led	40W 220-240V - 50/60Hz	
fan	34W 220-240V - 50/60Hz	
beam angle	120°	
potenza ventilatore / fan power	AC 34W 900rpm 1050rpm 1200rpm	
volume aria / air volume	20 m³ min.	
livello sonoro / sound level	48 dB	

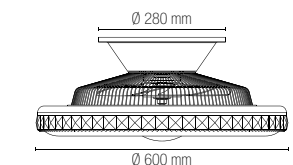

SKYRON



LED-SKYRON-INT
8031414873678

	colour temp.	colour
lumen	CCT 4450 lm	
led	40W 220-240V - 50/60Hz	
fan	34W 220-240V - 50/60Hz	
beam angle	120°	
potenza ventilatore / fan power	AC 34W 900rpm 1050rpm 1200rpm	
volume aria / air volume	20 m³ min.	
livello sonoro / sound level	48 dB	

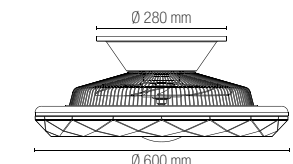

Materiale
acrilico PMMA
bianco effetto cielo stellato

Temperatura colore
CCT



Materiale ventilatore
7 lame bianche
in termoplastica

Caratteristiche ventilatore
7 lame ultra silenziose
con rotazione unilaterale.
Ghiera esterna roteante per
una maggiore diffusione dell'aria.

Driver
incluso

Material
PMMA acrylic white colour
with starry sky effect

Colour temperature
CCT



Fan material
7 white
thermoplastic blades

Fan characteristics
7 ultra-silent blades
unidirectional rotation
rotating outer ring for
greater air diffusion

Driver
included

Control system easy installation



On-off ghiera esterna /
On-off outer ring



Regolazione velocità ventole /
Fan speed adjustment



Impostazione timer /
Timer setting



Regolazione intensità di luce (dimmer) /
Light intensity (dimmer)



Regolazione gradi kelvin /
Adjustable white



Smart
Intec
WIFI



RF 2.4G
control
system



ALEXA e
GOOGLE
HOME
voice control



Plafoniere con ventilatore in acrilico PMMA.
Ceiling fan lamps with PMMA acrylic fan.

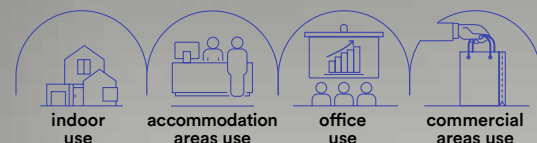

technical information



ALISEO



LED-ALISEO-INT
8031414873661

	colour temp.	colour
lumen	CCT 4450 lm	
led	40W 220-240V - 50/60Hz	
fan	34W 220-240V - 50/60Hz	
beam angle	120°	
potenza ventilatore / fan power	AC 34W 900rpm 1050rpm 1200rpm	
volume aria / air volume	20 m ³ min.	
livello sonoro / sound level	48 dB	

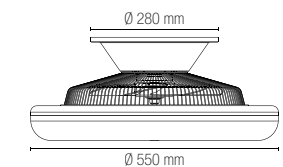

FOEHN



LED-FOEHN-INT
8031414873685

	colour temp.	colour
lumen	CCT 4450 lm	
led	40W 220-240V - 50/60Hz	
fan	34W 220-240V - 50/60Hz	
beam angle	120°	
potenza ventilatore / fan power	AC 34W 900rpm 1050rpm 1200rpm	
volume aria / air volume	20 m ³ min.	
livello sonoro / sound level	48 dB	

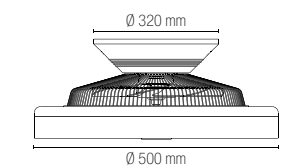

Materiale
acrilico PMMA

Temperatura colore
CCT



Materiale ventilatore
7 lame trasparenti
in termoplastica

Caratteristiche ventilatore

7 lame ultra
silenziose con
rotazione unilaterale

Driver
incluso

Material
PMMA acrylic

Colour temperature
CCT



Fan material
7 trasparent
thermoplastic blades

Fan characteristics

7 ultra-silent
blades unidirectional
rotation

Driver
included

Control system easy installation



On-off ghiera esterna /
On-off outer ring



Regolazione velocità ventole /
Fan speed adjustment



Impostazione timer /
Timer setting



Regolazione intensità di luce (dimmer) /
Light intensity (dimmer)



Regolazione gradi kelvin /
Adjustable white



Smart
Intec
WiFi



RF 2.4G
control
system



ALEXA e
GOOGLE
HOME
voice control



GRECALE

Plafoniera con ventilatore.
Ceiling lamp with fan.

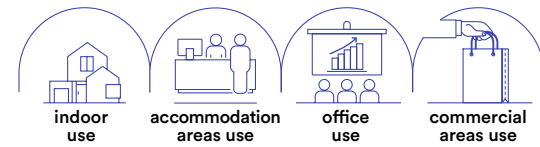

technical information GRECALE



Materiale
alluminio, acrilico

Colore
bianco
nero



Temperatura colore
CCT



Materiale ventilatore
7 lame
in termoplastica

Caratteristiche ventilatore
7 lame ultra silenziose
con rotazione bilaterale

Driver
incluso

Material
aluminum, acrylic

Colour
white
black



Colour temperature
CCT



Fan material
7 thermoplastic
blades

Fan characteristics
7 ultra-silent
blades

Driver
included



LED-GRECALE-W-INT
8031414885947

lumen	8470 lm
led	80W 220-240V - 50/60Hz
fan	22W 220-240V - 50/60Hz
beam angle	120°
potenza ventilatore / fan power	DC22W 6 velocità / speed
volume aria / air volume	20 m ³ min.
livello sonoro / sound level	48 dB

colour temp. colour



CCT 8470 lm

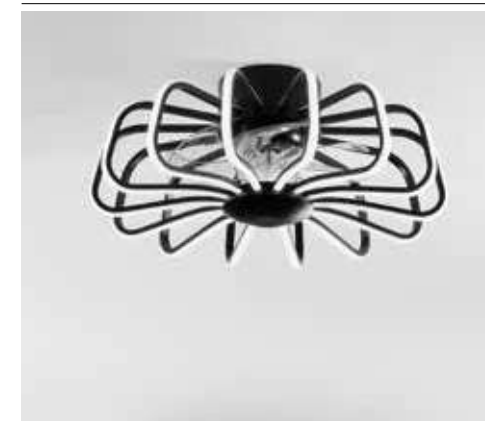
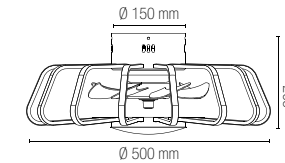

LED-GRECALE-B-INT
8031414885954

lumen	8470 lm
led	80W 220-240V - 50/60Hz
fan	22W 220-240V - 50/60Hz
beam angle	120°
potenza ventilatore / fan power	DC22W 6 velocità / speed
volume aria / air volume	20 m ³ min.
livello sonoro / sound level	48 dB

colour temp. colour



CCT 8470 lm

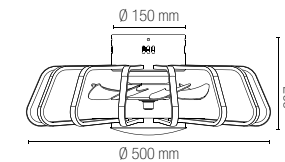

Reverse system - DC motor

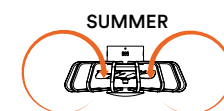

Control system easy installation

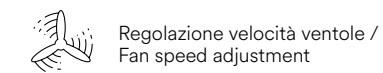

Regolazione velocità ventole /
Fan speed adjustment



Impostazione timer /
Timer setting



Regolazione intensità di luce (dimmer) /
Light intensity (dimmer)



Regolazione gradi kelvin /
Adjustable white



Smart
Intec
WIFI



RF 2.4G
control
system



ALEXA e
GOOGLE
HOME
voice control



Plafoniere con ventilatore in bianco effetto cielo stellato.
Ceiling fan lamps with white starry sky effect.



technical information



LEVANTE



LED-LEVANTE-INT
8031414885930

colour temp.	colour
CCT 4450 lm	
lumen	
led	40W 220-240V - 50/60Hz
fan	22W 220-240V - 50/60Hz
beam angle	120°
potenza ventilatore / fan power	DC22W 6 velocità / speed
volume aria / air volume	20 m ³ min.
livello sonoro / sound level	48 dB

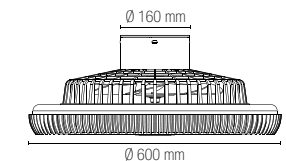

SCIROCCO



LED-SCIROCCO-INT
8031414885923

colour temp.	colour
CCT 4450 lm	
lumen	
led	40W 220-240V - 50/60Hz
fan	22W 220-240V - 50/60Hz
beam angle	120°
potenza ventilatore / fan power	DC22W 6 velocità / speed
volume aria / air volume	20 m ³ min.
livello sonoro / sound level	48 dB

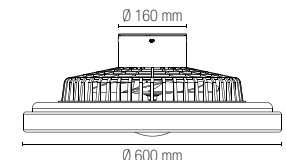

Materiale
acrilico PMMA
bianco effetto cielo stellato

Temperatura colore
CCT



Materiale ventilatore
7 lame bianche
in termoplastica

Caratteristiche ventilatore
7 lame ultra silenziose
con rotazione bilaterale,
ghiera esterna roteante per
una maggiore diffusione dell'aria

Driver
incluso

Material
PMMA acrylic white colour
with starry sky effect

Colour temperature
CCT



Fan material
7 white
thermoplastic blades

Fan characteristics
7 ultra-silent blades
bidirectional rotation
rotating outer ring for
greater air diffusion

Driver
included

Reverse system - DC motor

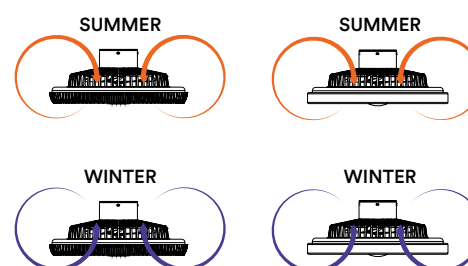

Control system easy installation

On-off ghiera esterna /
On-off outer ring

Regolazione velocità ventole /
Fan speed adjustment

Impostazione timer /
Timer setting

Regolazione intensità di luce (dimmer) /
Light intensity (dimmer)

Regolazione gradi kelvin /
Adjustable white



Smart
Intec
WIFI



RF 2.4G
control
system



ALEXA e
GOOGLE
HOME
voice control



ETESIA

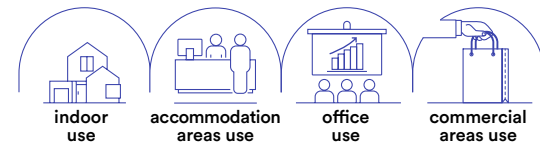

Materiale
alluminio, acrilico

Colore
bianco
nero



Temperatura colore
CCT



Materiale ventilatore
7 lame
in termoplastica

Caratteristiche ventilatore
7 lame ultra silenziose
con rotazione bilaterale

Driver
incluso

Material
aluminum, acrylic

Colour
white
black



Colour temperature
CCT



Fan material
7 thermoplastic
blades

Fan characteristics
7 ultra-silent
blades

Driver
incluso



Plafoniera con ventilatore.
Ceiling lamp with fan.

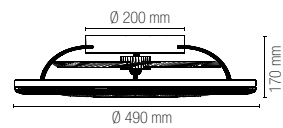

Reverse system - DC motor

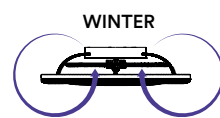
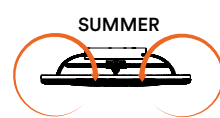

	colour temp.	colour
LED-ETESIA-W-FAN 8031414899005		
LED-ETESIA-B-FAN 8031414899012		
	CCT	
lumen	3300 lm	
led	30W 220-240V - 50/60Hz	
fan	22W 220-240V - 50/60Hz	
beam angle		120°
potenza ventilatore / fan power	DC22W 6 velocità / speed	
volume aria / air volume		20 m³ min.
livello sonoro / sound level		48 dB

Control system easy installation

Regolazione velocità ventole / Fan speed adjustment

Impostazione timer / Timer setting

Regolazione intensità di luce (dimmer) / Light intensity (dimmer)

Regolazione gradi kelvin / Adjustable white

PONENTE

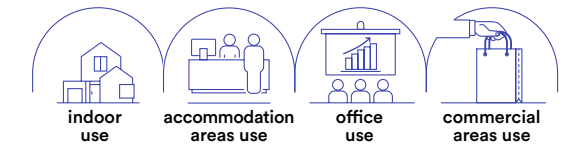

Materiale
alluminio, acrilico

Temperatura colore
CCT



Materiale ventilatore
7 lame trasparenti
in termoplastica

Caratteristiche ventilatore
7 lame ultra
silenziose
rotazione bilaterale

Driver
incluso

Material
aluminum, acrylic

Colour temperature
3000K / 4000K / 6500K



Fan material
7 trasparent
thermoplastic blades

Fan characteristics
7 ultra-silent
blades
bidirectional rotation

Driver
incluso



Plafoniera con ventilatore.
Ceiling lamp with fan.

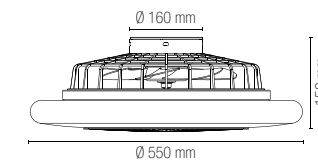

Reverse system - DC motor

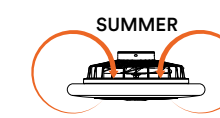

	colour temp.	colour
LED-PONENTE-FAN 8031414886586		
	CCT	
lumen	4450 lm	
led	40W 220-240V - 50/60Hz	
fan	22W 220-240V - 50/60Hz	
beam angle		120°
potenza ventilatore / fan power	DC 22W 6 velocità / speed	
volume aria / air volume		20 m³ min.
livello sonoro / sound level		48 dB

Control system easy installation

Regolazione velocità ventole / Fan speed adjustment

Impostazione timer / Timer setting

Regolazione intensità di luce (dimmer) / Light intensity (dimmer)

Regolazione gradi kelvin / Adjustable white

Plafoniera con ventilatore.
Ceiling lamp with fan.

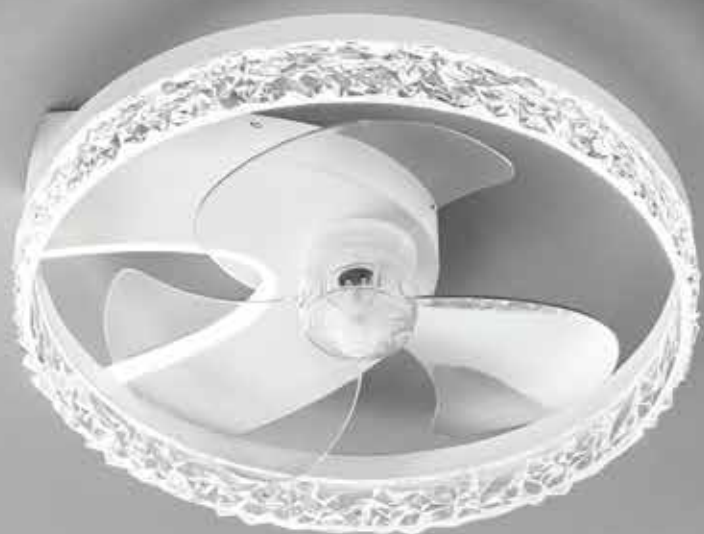

technical information



ESPERO



LED-ESPERO-FAN

8031414898992

colour temp.	colour
CCT	
lumen	4800 lm
led	30W 220-240V - 50/60Hz
fan	22W 220-240V - 50/60Hz
beam angle	120°
potenza ventilatore / fan power	DC22W 6 velocità / speed
volume aria / air volume	20 m ³ min.
livello sonoro / sound level	48 dB

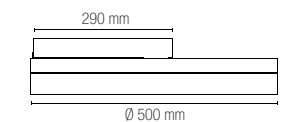

NASHI



LED-NASHI-FAN

8031414899029

colour temp.	colour
CCT	
lumen	4800 lm
led	30W 220-240V - 50/60Hz
fan	22W 220-240V - 50/60Hz
beam angle	120°
potenza ventilatore / fan power	DC22W 6 velocità / speed
volume aria / air volume	20 m ³ min.
livello sonoro / sound level	48 dB

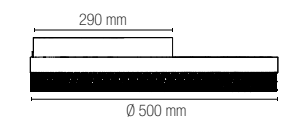

Materiale
alluminio, acrilico

Temperatura colore
CCT



Materiale ventilatore
3 lame trasparenti
in termoplastica

Caratteristiche ventilatore
3 lame ultra
silenziose
rotazione bilaterale

Driver
incluso

Material
aluminum, acrylic

Colour temperature
3000K / 4000K / 6500K



Fan material
3 transparent
thermoplastic blades

Fan characteristics
3 ultra-silent
blades
bidirectional rotation

Driver
included

Reverse system - DC motor

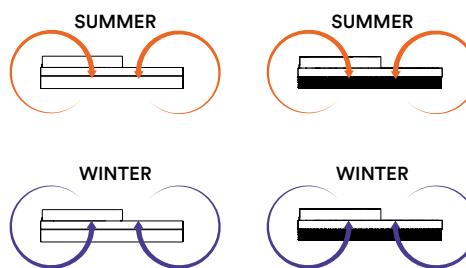

Control system easy installation

Regolazione velocità ventole /
Fan speed adjustment

Impostazione timer /
Timer setting

Regolazione intensità di luce (dimmer) /
Light intensity (dimmer)

Regolazione gradi kelvin /
Adjustable white

MOON

Plafoniera a LED in acrilico PMMA effetto cielo stellato.
Ceiling LED acrylic PMMA starry sky effect.

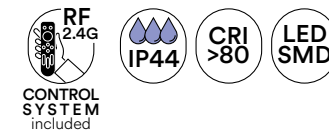
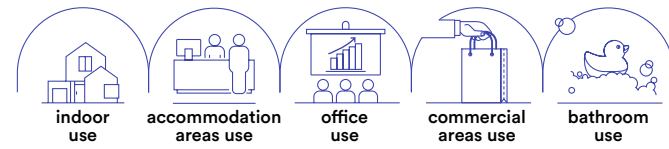

technical information **MOON**

- Materiale**
acrilico PMMA
- Colore**
bianco
effetto cielo stellato
- Driver**
integrato
- Material**
PMMA acrylic
- Colour**
white
with starry sky effect
- Driver**
built-in driver

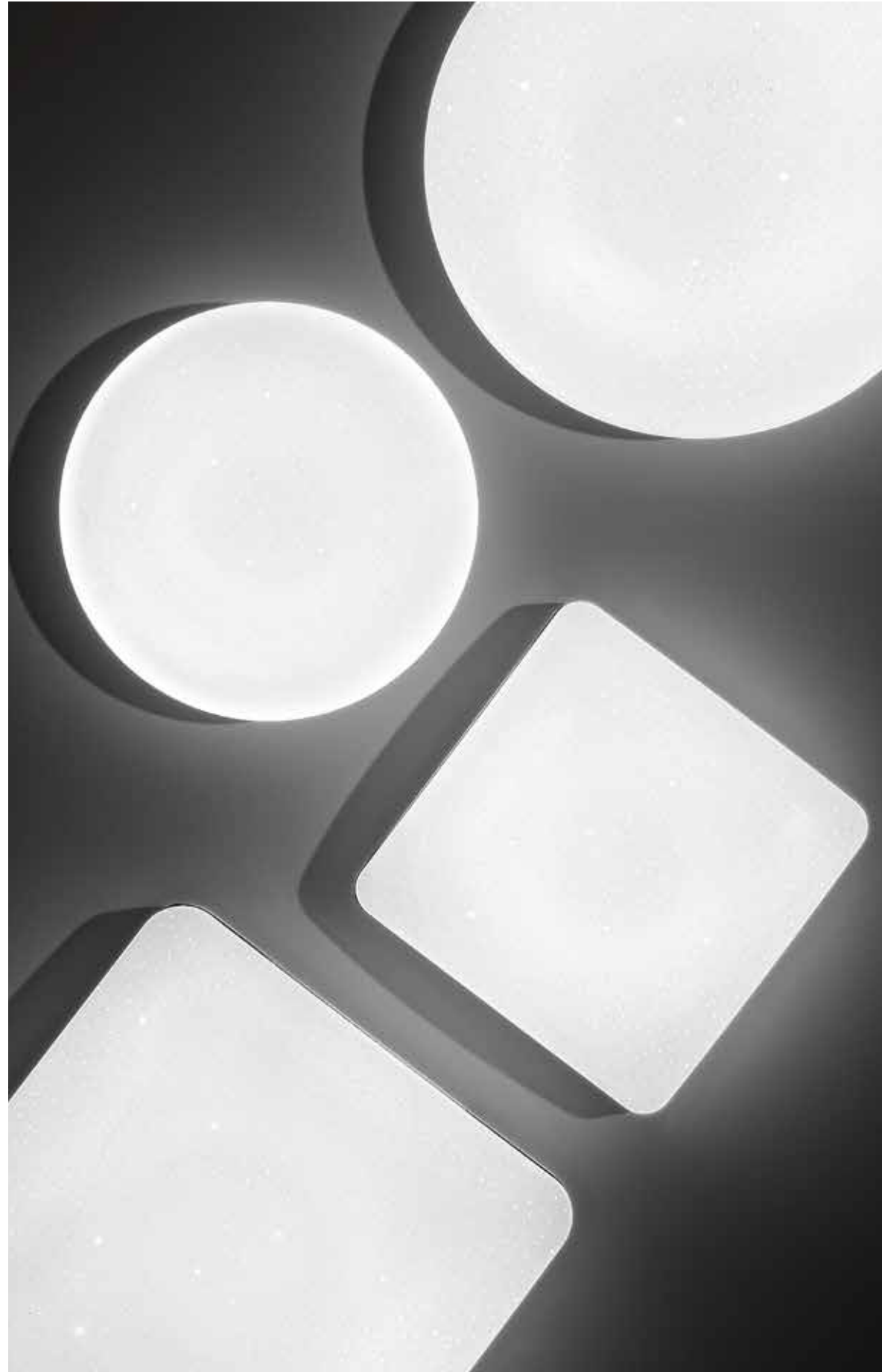

I-MOON-R40-CCT	I-MOON-R30-CCT	I-MOON-Q38-CCT	I-MOON-Q28-CCT
 8031414879823	 8031414879847	 8031414879830	 8031414879854
colour temp. CCT lumen 2460 lm watt 24W beam angle 120°	colour temp. CCT lumen 1815 lm watt 18W beam angle 120°	colour temp. CCT lumen 2460 lm watt 24W beam angle 120°	colour temp. CCT lumen 1815 lm watt 18W beam angle 120°
 Ø 385 mm 100 mm	 Ø 300 mm 66 mm	 360x360 mm 75 mm	 270x270 mm 65 mm

I-MOON-R40-INT	colour temp.
8031414863488	 RGB + 4000K
lumen 2460 lm watt 24W beam angle 120°	2460 lm
 Ø 385 mm 100 mm	

Control system easy installation

Smart Intec WIFI

RF 2.4G control system

ALEXA e GOOGLE HOME voice control

SMART INTEC

SMART LIFE

Powered by TUYA
 Intelligence Inside

STREAM

Plafoniera a LED in acrilico con decorazioni a rilievo.
Acrylic LED ceiling light with relief decorations.

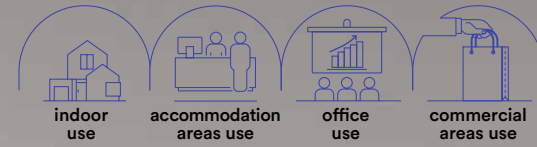

Materiale
acrilico PMMA

Material
PMMA acrylic

Colore
bianco

Colour
white

Temperatura colore selezionabile
3000K / 4000K / 6500K

Selectable color temperature
3000K / 4000K / 6500K



Driver
incluso

Driver
included



technical information **STREAM**



I-STREAM-PL30
8031414894987
lumen

colour temp.	colour
2640 lm	

watt	18W
beam angle	120°

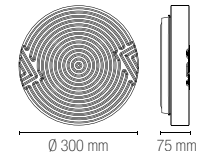

I-STREAM-PL40
8031414894994
lumen

colour temp.	colour
3520 lm	

watt	24W
beam angle	120°

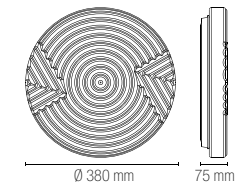

I-STREAM-PL50
8031414895007
lumen

colour temp.	colour
6000 lm	

watt	40W
beam angle	120°

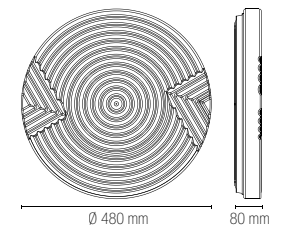

I-STREAM-PL60
8031414895014
lumen

colour temp.	colour
CCT 7120 lm	

watt	48W
beam angle	120°

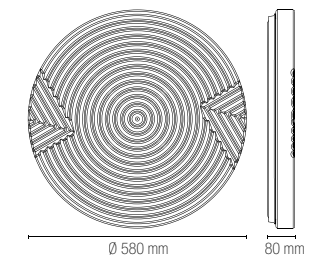

DOMO

Plafoniera in alluminio con diffusore in acrilico.
Aluminum ceiling lamp with acrylic diffuser.

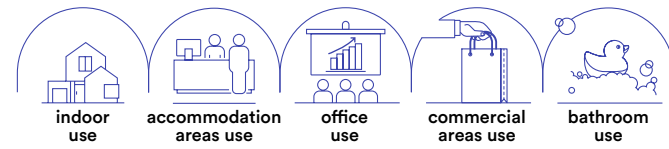

technical information **DOMO**



Materiale
alluminio,
diffusore in acrilico

Colore
bianco
nero
cromo



Temperatura colore
4000K



Driver
incluso

Material
aluminum,
acrilic diffuser

Colour
white
black
chrome



Colour temperature
4000K



Driver
included



	colour temp.	colour
LED-DOMO-R24-BCO 8031414882779 lumen	2700 lm	
LED-DOMO-R24-NER 8031414893836 lumen	2700 lm	
LED-DOMO-R24 8031414876228 lumen	2700 lm	
watt		24W
beam angle		120°

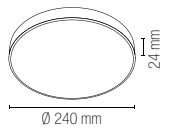

	colour temp.	colour
LED-DOMO-Q24-BCO 8031414882762 lumen	2700 lm	
LED-DOMO-Q24 8031414876235 lumen	2700 lm	
LED-DOMO-Q24 NER 8031414893843 lumen	2700 lm	
watt		24W
beam angle		120°

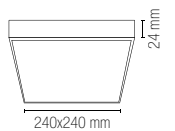

BLASTER

Applique a LED con struttura cromata e diffusore in policarbonato.
LED wall lamp with chromed structure and polycarbonate diffuser.



CRUISE

Applique a LED con struttura in termoplastica e diffusore in acrilico con fissaggio su cornice o su specchio.
LED wall lamp with thermoplastic structure and acrylic diffuser with frame and mirror fixing.



In.tec light APPLIQUE E PLAFONIERE / WALL LAMPS AND CEILING LAMPS

Materiale
alluminio,
diffusore in PC

Colore
struttura cromata
diffusore bianco

Temperatura colore
4000K



Driver
integrato

Material
aluminum,
PC diffuser

Colour
chrome structure
white diffuser

Colour temperature
4000K



Driver
built-in driver

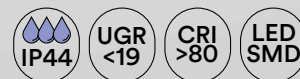

LED-BLASTER-60

8031414866526
lumen

colour temp.
1720 lm

watt 15W
beam angle 133°

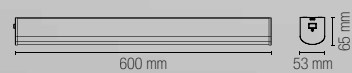

LED-BLASTER-PLUG

8031414866519
lumen

colour temp.
1000 lm

watt 8W
beam angle 133°

plug max 2000W

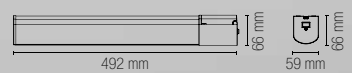

Temperatura colore
4000K



Driver
integrato

Colour temperature
4000K



Driver
built-in driver



SPOT-B-CRUISE-BCO

8031414897636
lumen

colour temp.
440 lm

SPOT-B-CRUISE-NER

8031414897674
lumen

colour
440 lm

SPOT-B-CRUISE

8031440363426
lumen

colour
440 lm

watt 5,2W
beam angle 120°

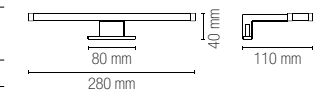

LANCER

Applique a LED in alluminio bianco, nero, cromato ed oro spazzolato.
LED wall light in white, black, chrome and brushed gold aluminum.



technical information **LANCER**



Materiale

alluminio,
diffusore in PC

Colore

bianco goffrato
nero goffrato
cromo
oro spazzolato



Temperatura colore

3000K / 4000K



Driver

integrato

Material

aluminum,
PC diffuser

Colour

embossed white
embossed black
chrome
brushed gold



Colour temperature

3000K / 4000K



Driver

built-in driver



	colour temp.	colour
LED-W-LANCER-C BCO 8031414876679		
lumen	1000 lm	
LED-W-LANCER BCO 8031440361200		
lumen	1000 lm	
watt	13W	
beam angle	120°	

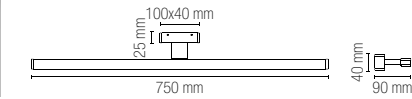

	colour temp.	colour
LED-W-LANCER NERO 8031440361217		
lumen	1000 lm	
watt	13W	
beam angle	120°	

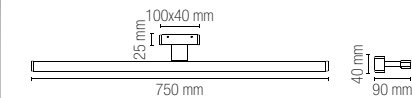

	colour temp.	colour
LED-W-LANCER CR 8031414882564		
lumen	1000 lm	
watt	13W	
beam angle	120°	

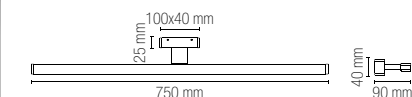

	colour temp.	colour
LED-W-LANCER ORO 8031414882571		
lumen	1000 lm	
watt	13W	
beam angle	120°	

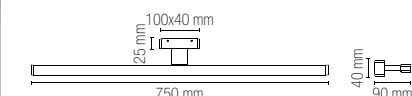

SACS

Applique a LED con struttura in termoplastica e diffusore in acrilico con fissaggio su cornice o su specchio.

LED wall lamp with thermoplastic structure and acrylic diffuser with frame and mirror fixing.



Temperatura colore
4000K

Driver
integrato

Colour temperature
4000K

Driver
built-in driver

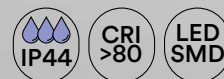

	colour temp.	colour	colour temp.	colour
SPOT-B-SACS-XL 8031414877010	819 lm		SPOT-B-SACS 8031414870776	438 lm
watt		7W	watt	5W
beam angle		120°	beam angle	120°

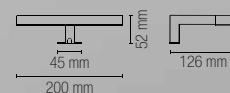
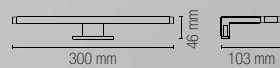

RIVA

Applique a LED con struttura in termoplastica e diffusore in acrilico con fissaggio su cornice o su specchio.

LED wall lamp with thermoplastic structure and acrylic diffuser with frame and mirror fixing.



Temperatura colore
4000K

Driver
integrato

Colour temperature
4000K

Driver
built-in driver



	colour temp.	colour
SPOT-B-RIVA 8031440363457	575 lm	
watt		8W
beam angle		120°

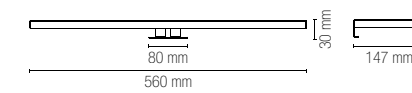

AQA

Applique a LED con struttura in alluminio e diffusore in acrilico con fissaggio su cornice o su specchio.
LED wall lamp with aluminum structure and acrylic diffuser with frame and mirror fixing.



Materiale
alluminio,
diffusore in PC

Material
aluminum,
PC diffuser

Colore
struttura cromata
diffusore bianco

Colour
chrome structure
white diffuser

Temperatura colore
4000K

Colour temperature
4000K

Driver
integrato

Driver
built-in driver



SPOT-B-AQA
8031414877027
lumen

colour temp.	colour
●	●
819 lm	

watt	8W
beam angle	120°

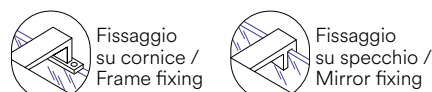
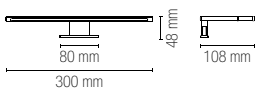

SCARAB

Applique a LED con struttura in alluminio e diffusore in acrilico con fissaggio su cornice o su specchio.

LED wall lamp with aluminum structure and acrylic diffuser with frame and mirror fixing.



Temperatura colore
4000K



Driver
integrato

Colour temperature
4000K



Driver
built-in driver



SPOT-B-SCARAB
8031440363440
lumen

colour temp.	colour
●	●
280 lm	

watt	3W
beam angle	120°

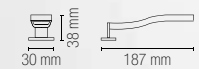

WALLY

Applique a LED con struttura in alluminio e diffusore in acrilico con fissaggio su cornice o su specchio.

LED wall lamp with aluminum structure and acrylic diffuser with frame and mirror fixing.

Temperatura colore
4000K



Driver
integrato

Colour temperature
4000K



Driver
built-in driver



SPOT-B-WALLY
8031440363471
lumen

colour temp.	colour
●	●
910 lm	

watt	8W
beam angle	120°

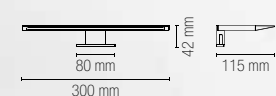

F1

Applique metallo flessibile cromo con diffusore in vetro bianco satinato.
Flexible chrome metal wall lamp with satin white glass diffuser.

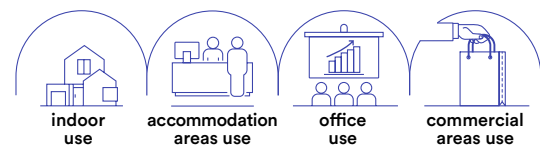

Q1

Applique metallo cromo con diffusore in vetro satinato.
Chrome metal wall lamp with satin glass diffuser.

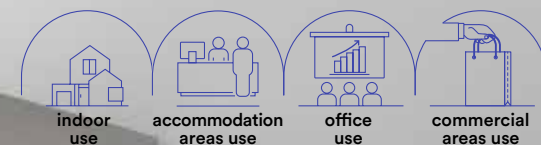

ROBY

Applique da specchio in metallo cromato con diffusore in vetro bianco cromato.
Mirror wall lamp in chromed metal with white chromed glass diffuser.



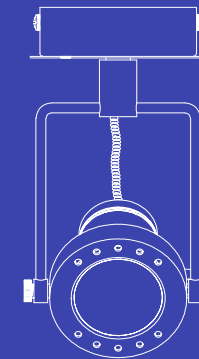

SPOT E FARETTI

SPOT LIGHTS

ZERO

Spot in metallo con punti luce orientabili, disponibili nelle versioni nero o bianco opaco.

Metal spot with adjustable light points, available in black or white matt.

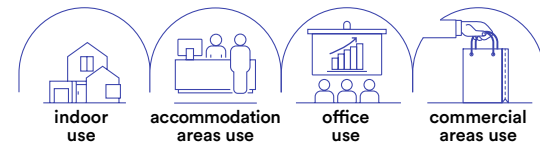

technical information **ZERO**



	colour
SPOT-ZERO-1 BCO 8031414866878	
SPOT-ZERO-1 NER 8031414866915	
1 x GU10 MAX 35W	

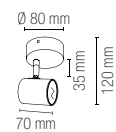

Lampadina non inclusa /
Light bulb not included



	colour
SPOT-ZERO-2 BCO 8031414866885	
SPOT-ZERO-2 NER 8031414866922	
2 x GU10 MAX 35W	

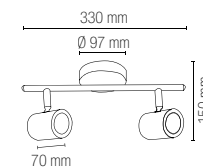

	colour
SPOT-ZERO-PL3 BCO 8031414866861	
SPOT-ZERO-PL3 NER 8031414866908	
3 x GU10 MAX 35W	

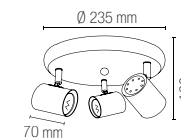

	colour
SPOT-ZERO-4 BCO 8031414866854	
SPOT-ZERO-4 NER 8031414866892	
4 x GU10 MAX 35W	

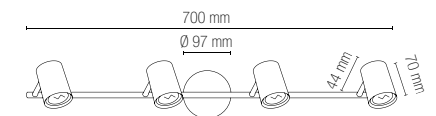

PUNTO

Spot in metallo con punti luce orientabili
disponibili nelle versioni nero o bianco opaco.

Metal spot with adjustable light points
available in black or matt white versions.

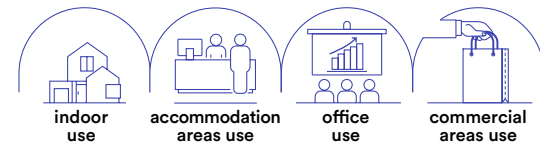

technical information **PUNTO**



	colour
SPOT-PUNTO-1 BCO 8031414866830	
SPOT-PUNTO-1 NER 8031414867011	

1 x E27 MAX 40W

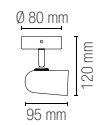

Lampadina non inclusa /
Light bulb not included



	colour
SPOT-PUNTO-2 BCO 8031414866847	
SPOT-PUNTO-2 NER 8031414867028	

2 x E27 MAX 40W

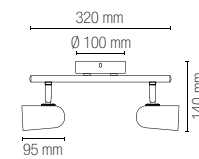

	colour
SPOT-PUNTO-PL3 BCO 8031414867042	
SPOT-PUNTO-PL3 NER 8031414867004	

3 x E27 MAX 40W

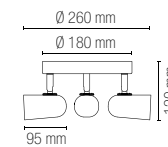

	colour
SPOT-PUNTO-4 BCO 8031414867035	
SPOT-PUNTO-4 NER 8031414866991	

4 x E27 MAX 40W

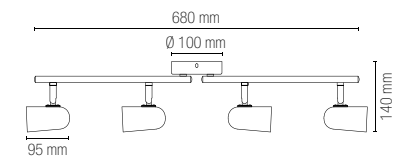

TECHNO

Spot in metallo con punti luce orientabili
in bianco o nero opaco e nikel spazzolato.
Metal spot with adjustable light points
in white or matt black and brushed nickel.

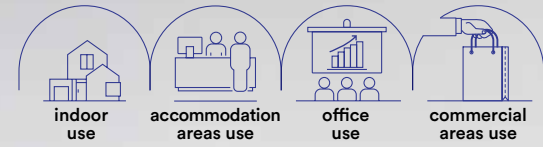

In.tec light SPOT E FARETTI / SPOT LIGHTS

Accessori inclusi /
Included accessories



Lampadine LED SMD /
LED SMD light bulbs

watt	5W
beam angle	100°
cri	80
on/off	>10.000
4000K	
lumen	400 lm
dimmer	

Accessori inclusi /
Included accessories



Lampadine LED SMD /
LED SMD light bulbs

watt	5W
beam angle	100°
cri	80
on/off	>10.000
4000K	
lumen	400 lm
dimmer	

Accessori inclusi /
Included accessories



Lampadine LED SMD /
LED SMD light bulbs

watt	5W
beam angle	100°
cri	80
on/off	>10.000
2700K	
lumen	400 lm
dimmer	

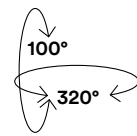

colour

SPOT-TECHNO-1 BCO
8031414864638

SPOT-TECHNO-1 NER
8031414864652

SPOT-TECHNO-1
8031422881108

1 x GU10

5W LED

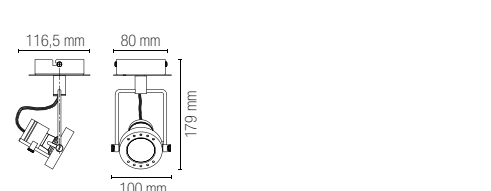

colour

SPOT-TECHNO-2 BCO
8031414864645

SPOT-TECHNO-2 NER
8031414864669

SPOT-TECHNO-2
8031422891107

2 x GU10

5W LED

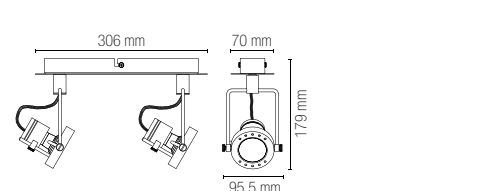

colour

SPOT-TECHNO-3 BCO
8031414864515

SPOT-TECHNO-3 NER
8031414864539

SPOT-TECHNO-3
8031423041105

3 x GU10

5W LED

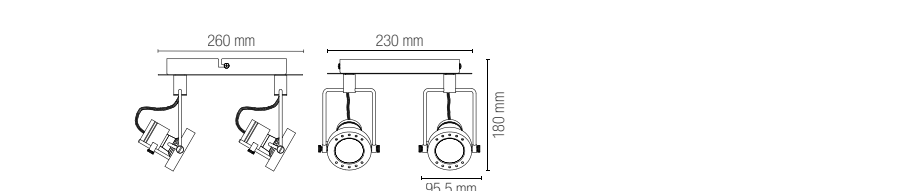

colour

SPOT-TECHNO-PL4 BCO
8031414864522

SPOT-TECHNO-PL4 NER
8031414864546

SPOT-TECHNO-PL4
8031423051104

4 x GU10

5W LED



SUNNY

Spot in metallo con punti luce orientabili, base cromo e finitura in nikel spazzolato.

Metal spot with adjustable light, chromed base and brushed nickel finish.

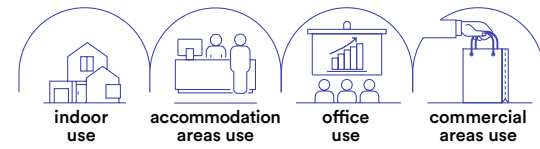

technical information **SUNNY**



colour

SPOT-SUNNY-1
8031431831187



1 x GU10 5W LED

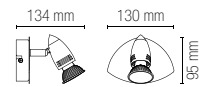

colour

SPOT-SUNNY-2
8031431841186



2 x GU10 5W LED

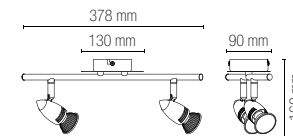

colour

SPOT-SUNNY-S3
8031431861184



3 x GU10 5W LED

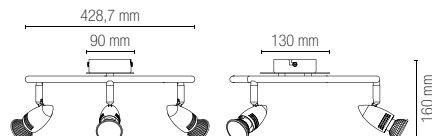

colour

SPOT-SUNNY-4
8031431851185



4 x GU10 5W LED

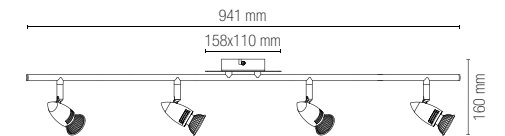

Accessori inclusi / Included accessories

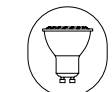

Lampadine LED SMD / LED SMD light bulbs

watt	5W
beam angle	100°
cri	80
on/off	>10.000
2700K	
lumen	400 lm
dimmer	

MIAMI

Spot in metallo con punti luce orientabili con finitura in nikel spazzolato e base con cornice in vetro trasparente.
Metal spot with adjustable light points with brushed nickel finish and base with transparent glass frame.

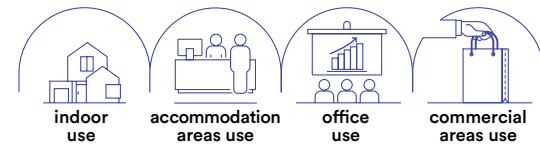

technical information **MIAMI**



colour

SPOT-MIAMI 01
8031414076772



1 x GU10 5W LED

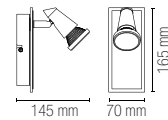

colour

SPOT-MIAMI 02
8031414076796



2 x GU10 5W LED

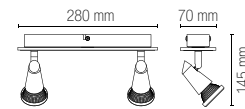

colour

SPOT-MIAMI 03
8031414076802



3 x GU10 5W LED

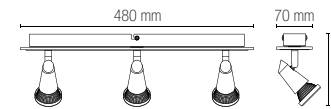

colour

SPOT-MIAMI PL4
8031414076819



4 x GU10 5W LED

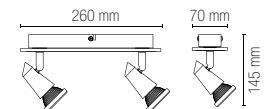

SPOT E FARETTI / SPOT LIGHTS

In.tec light

Accessori inclusi / Included accessories



Lampadine LED SMD / LED SMD light bulbs

watt	5W
beam angle	100°
cri	80
on/off	>10.000
2700K	
lumen	400 lm
dimmer	

COOPER

Spot in metallo con punti luce orientabili con finitura silver.
Metal spot with adjustable light points with silver finish.

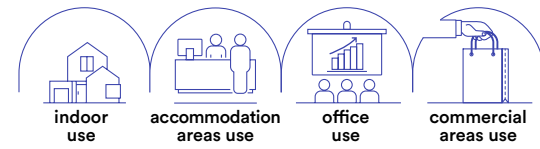

technical information **COOPER**



colour

SPOT-COOPER-1
8031440360913



1 x GU10 5W LED

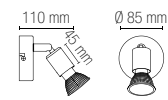

colour

SPOT-COOPER-2
8031440360920



2 x GU10 5W LED

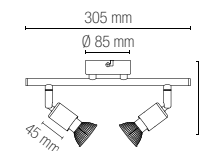

colour

SPOT-COOPER-3
8031440360937



3 x GU10 5W LED

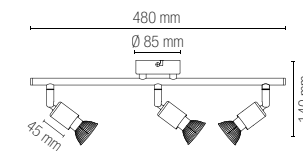

colour

SPOT-COOPER-4
8031440360944



4 x GU10 5W LED

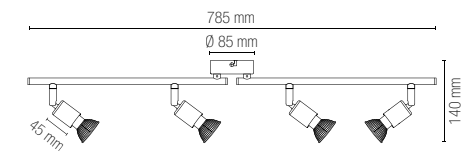

Accessori inclusi / Included accessories

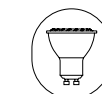

Lampadine LED SMD / LED SMD light bulbs

watt	5W
beam angle	100°
cri	80
on/off	>10.000
2700K	
lumen	400 lm
dimmer	

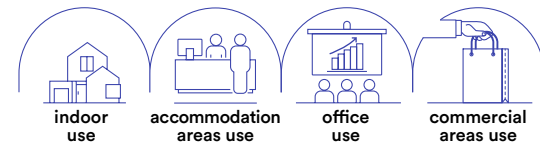

CADILLAC

Spot in metallo con punti luce orientabili e finitura cromo.

Metal spot with adjustable light points and chrome finish.

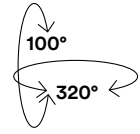

Lampadina consigliata
Lampadina non inclusa /
Suggested light bulb
Light bulb not included



SPOT-CADILLAC-1
8031438541256

1 x E14 MAX 40W

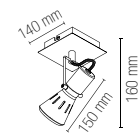

SPOT-CADILLAC-2
8031438551255

2 x E14 MAX 40W

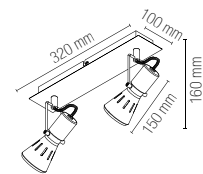

SPOT-CADILLAC-3
8031414076918

3 x E14 MAX 40W

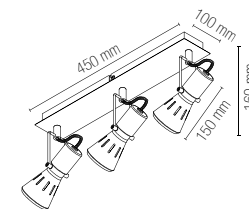

SPOT-CADILLAC-PL4
8031438521258

4 x E14 MAX 40W

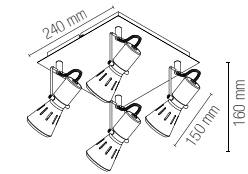

MITO

Spot in metallo con punti luce orientabili, finitura in nikel spazzolato e diffusori in vetro bianco.

Metal spot with adjustable light points, brushed nickel finish and white glass diffusers.

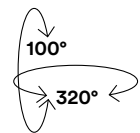

Lampadina non inclusa /
Light bulb not included



SPOT-MITO-1
8031431791184

1 x E14 MAX 40W

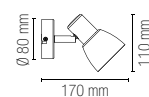

SPOT-MITO-PL3
8031431801180

3 x E14 MAX 40W

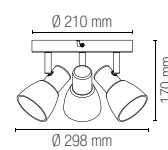

SPOT-MITO-S3
8031431811189

3 x E14 MAX 40W

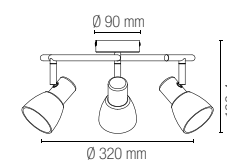

SPOT-MITO-S4
8031431821188

4 x E14 MAX 40W

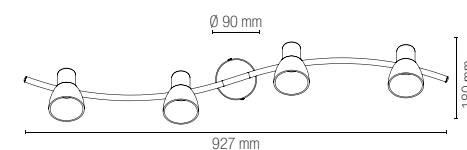

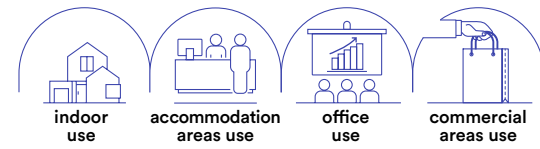

technical information **CARRERA / DOUBLEU**

CARRERA

Spot in metallo con punti luce orientabili con finitura in bianco.
Metal spot with adjustable light points with white finish.

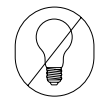
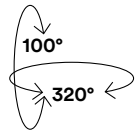

Lampadina non inclusa /
Light bulb not included

CE		CE		CE		CE		CE	
	colour		colour		colour		colour		colour
SPOT-CARRERA-1 8031431701183	●	SPOT-CARRERA-C 8031431731180	●	SPOT-CARRERA-2 8031431711182	●	SPOT-CARRERA-3 8031431721181	●	SPOT-CARRERA-PL3 8031431741189	●
1 x E27 MAX 40W		1 x E27 MAX 40W		2 x E27 MAX 40W		3 x E27 MAX 40W		3 x E27 MAX 40W	
		 Cavo / Cable 150 cm							

DOUBLEU

Base lampada in termoplastica bianca lucida.
Lamp base in glossy white thermoplastic.



Lampadina non inclusa /
Light bulb not included

CE		CE	
	colour		colour
I-PORTALAMPADE-E27-WO 8031440364874	●	I-PORTALAMPADE-E27-WS 8031440364867	●
1 x E27 MAX 42W		1 x E27 MAX 42W	



SOTTOPENSILI E BARRE LED

CABINETS AND LEDBARS

UNIX

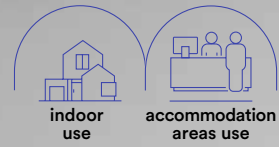

Materiale
struttura in alluminio,
diffusore in PC
riflettente

Colore
nikel



Temperatura colore
4000K



Driver
incluso

Material
nikel

Colour
aluminum body
with PC
reflective diffuser



Colour temperature
4000K



Driver
included



collection UNIX

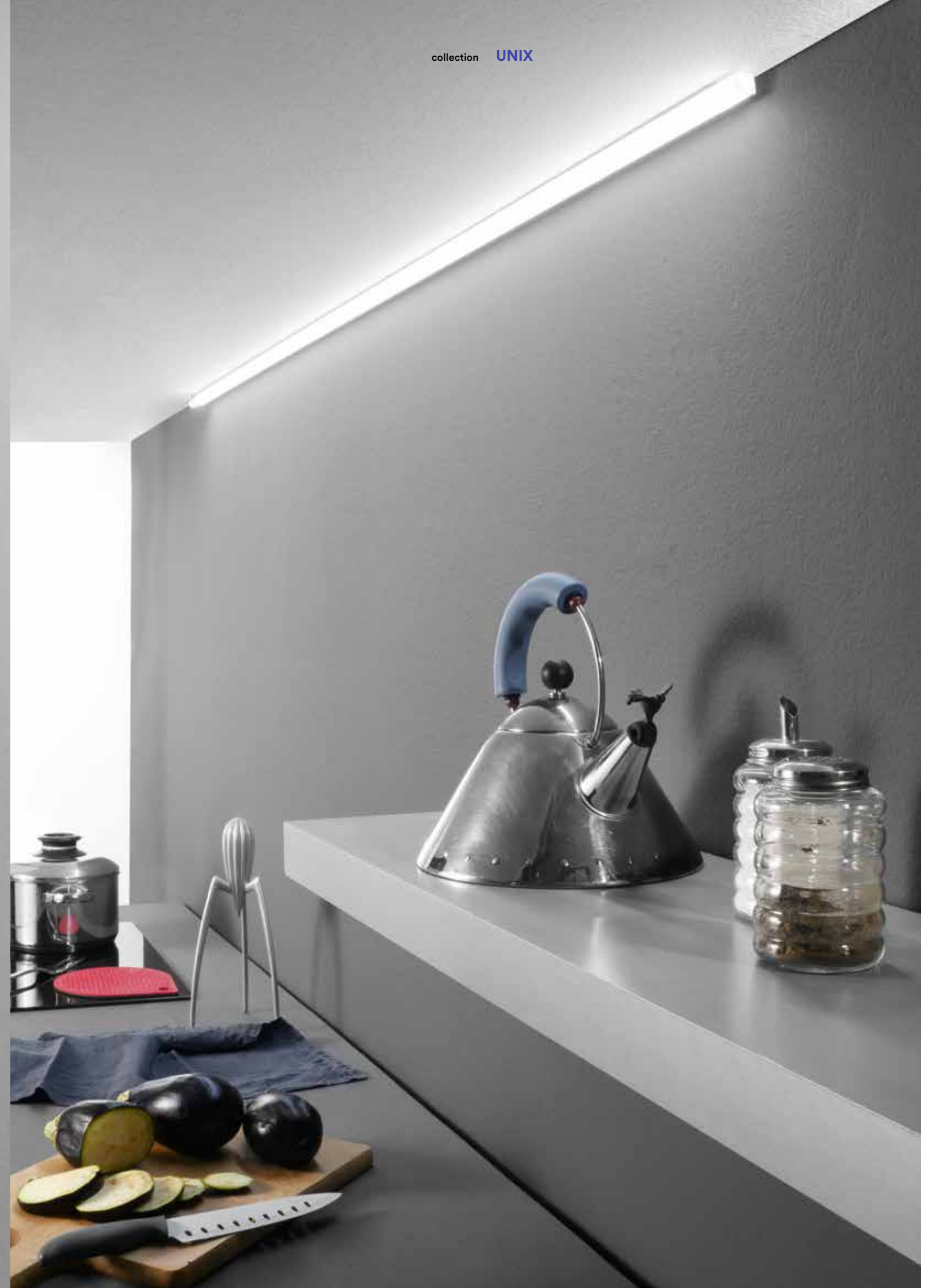

In.tec light SOTTOPENSILI E BARRE LED / CABINETS AND LEDBARS

**Barra sottopensile
in alluminio con
diffusore in PC riflettente.**
Cabinet bar with aluminum
structure under wall unit
with reflective PC diffuser.



Accessori inclusi / Included accessories



Staffe / Brackets

	colour temp.	colour
LEDBAR-UNIX-30 8031414866403		
lumen	400 lm	
watt	5,76W	
beam angle	120°	

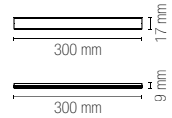

Accessori inclusi /
Included accessories

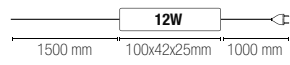

LEDBAR-UNIX-45 8031414864614		
lumen	600 lm	
watt	8,64W	
beam angle	120°	

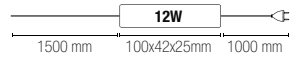
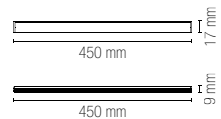

LEDBAR-UNIX-60 8031414864621		
lumen	800 lm	
watt	11,52W	
beam angle	120°	

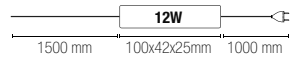
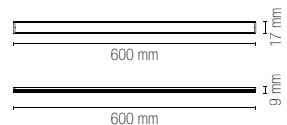

LEDBAR-UNIX-90 8031414864492		
lumen	1180 lm	
watt	17,28W	
beam angle	120°	

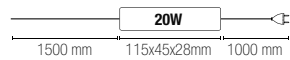
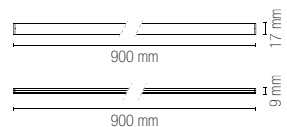

LEDBAR-UNIX-120 8031414864508		
lumen	1560 lm	
watt	23,04W	
beam angle	120°	

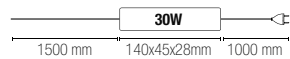
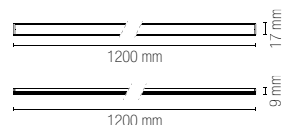

LEDBAR-UNIX-150 8031414865185		
lumen	1950 lm	
watt	28,8W	
beam angle	120°	

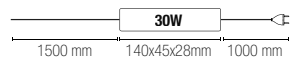
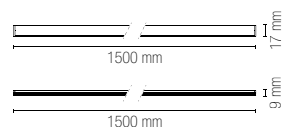

LEDBAR-UNIX-180 8031414865154		
lumen	2350 lm	
watt	34,56W	
beam angle	120°	

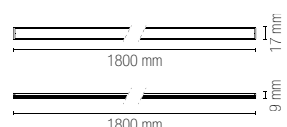

LEDBAR-UNIX-210 8031414865161		
lumen	2730 lm	
watt	40,32W	
beam angle	120°	

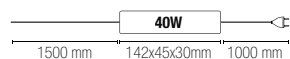
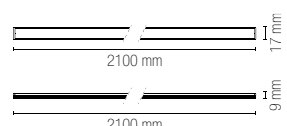

LEDBAR-UNIX-270 8031414865178		
lumen	3510 lm	
watt	51,84W	
beam angle	120°	

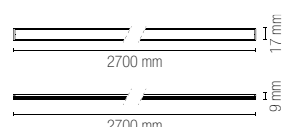

LEDBAR-UNIX-300 8031414870738		
lumen	3900 lm	
watt	57,6W	
beam angle	120°	

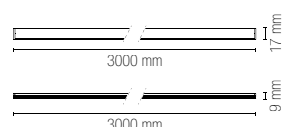

**Barra sottopensile
angolare in alluminio con
diffusore in PC riflettente.**
Angular cabinet bar with
aluminum structure under wall
unit with reflective PC diffuser.



Accessori inclusi / Included accessories



Staffe / Brackets

	colour temp.	colour
LEDBAR-UNIX-45 ANG 8031414864607		
lumen	600 lm	
watt	8,64W	
beam angle	120°	

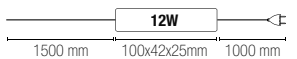
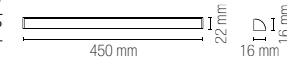

LEDBAR-UNIX-60 ANG 8031414864478		
lumen	800 lm	
watt	11,52W	
beam angle	120°	

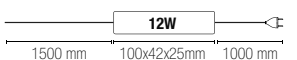
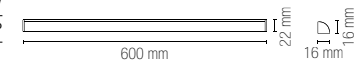

LEDBAR-UNIX-90 ANG 8031414864485		
lumen	1180 lm	
watt	17,28W	
beam angle	120°	

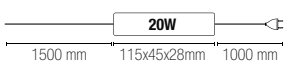
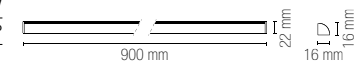

LEDBAR-UNIX-120 ANG 8031414864577		
lumen	1560 lm	
watt	23,04W	
beam angle	120°	

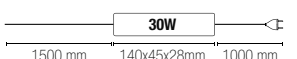
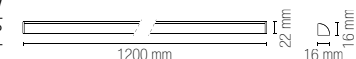

LEDBAR-UNIX-150 ANG 8031414866373		
lumen	1950 lm	
watt	28,8W	
beam angle	120°	

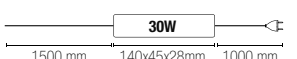
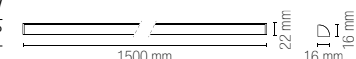

LEDBAR-UNIX-180 ANG 8031414866380		
lumen	2350 lm	
watt	34,56W	
beam angle	120°	

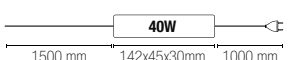
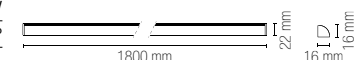

LEDBAR-UNIX-210 ANG 8031414866359		
lumen	2730 lm	
watt	40,32W	
beam angle	120°	

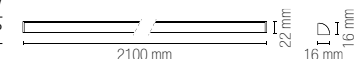

LEDBAR-UNIX-240 ANG 8031414866366		
lumen	3120 lm	
watt	46,08W	
beam angle	120°	

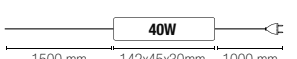
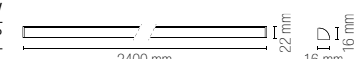

LEDBAR-UNIX-300 ANG 8031414866342		
lumen	3900 lm	
watt	57,6W	
beam angle	120°	

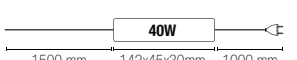
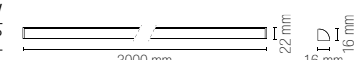

T8

Barra sottopensile con struttura in alluminio a LED integrato con diffusore in PC.

Cabinet bar with integrated LED aluminum structure for under cabinet with PC diffuser.

Materiale

struttura in alluminio, diffusore in PC

Colore

bianco



Temperatura colore

4000K



Driver

integrato

Material

aluminum body with PC diffuser

Colour

white



Colour temperature

4000K



Driver

built-in



technical information T8



colour temp. | colour

LEDBAR-T8-60

8031414875382

lumen 850 lm
watt 9W
beam angle 120°

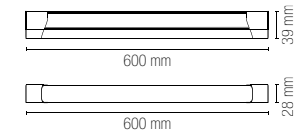

LEDBAR-T8-120

8031414875399

lumen 1700 lm
watt 18W
beam angle 120°

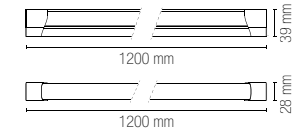

LEDBAR-T8-150

8031414875405

lumen 2300 lm
watt 24W
beam angle 120°

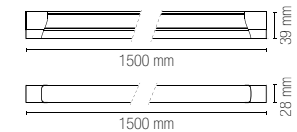

BATTEN

Barra ultra sottile a LED integrato.
Ultra slim cabinet built-in LED bar.

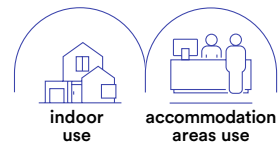

technical information **BATTEN**



Materiale

struttura in PC bianco,
diffusore in PC bianco

Colore
bianco

Temperatura colore
4000K

Driver
integrato

Material
PC white body with
PC white diffuser

Colour
white

Colour temperature
4000K

Driver
built-in



	colour temp.	colour		Accessori inclusi / Included accessories
LED-BATTEN-30 8031440357722				 Staffe / Brackets
lumen	1077 lm			
watt	9W			
beam angle	120°			
LED-BATTEN-60 8031440357739				 Staffe / Brackets
lumen	2166 lm			
watt	18W			
beam angle	120°			
LED-BATTEN-120 8031440357746				 Staffe / Brackets
lumen	4252 lm			
watt	36W			
beam angle	120°			
LED-BATTEN-150 8031440357753				 Staffe / Brackets
lumen	5677 lm			
watt	48W			
beam angle	120°			

SOTTOPENSILI E BARRE LED / CABINETS AND LEDBARS

In.tec light

HABILIS

Barra sottopensile angolare in alluminio a LED integrato con diffusore in PC.
Angular cabinet bar with integrated LED aluminum structure with PC diffuser.



technical information **HABILIS**



Materiale struttura in alluminio diffusore in PC	Material aluminum body with PC diffuser
Colore bianco	Colour white
Temperatura colore 4000K	Colour temperature 4000K
Interruttore incluso	Switch included
Driver integrato	Driver built-in

	colour temp.	colour
LED-HABILIS-AP 8031414881604		
lumen	1750 lm	
watt	15W	
beam angle	105°	
	2 plug max 16A	
	2 USB 2.4A	



T5

Barra sottopensile con struttura e diffusore in PC.
Cabinet bar with PC structure and diffuser.

Materiale

struttura in PC
diffusore in PC

Colore
bianco

Temperatura colore
4000K

Interruttore
incluso

Driver
integrato

Material

PC white body with
PC white diffuser

Colour
white

Colour temperature
4000K

Switch
included

Driver
built-in

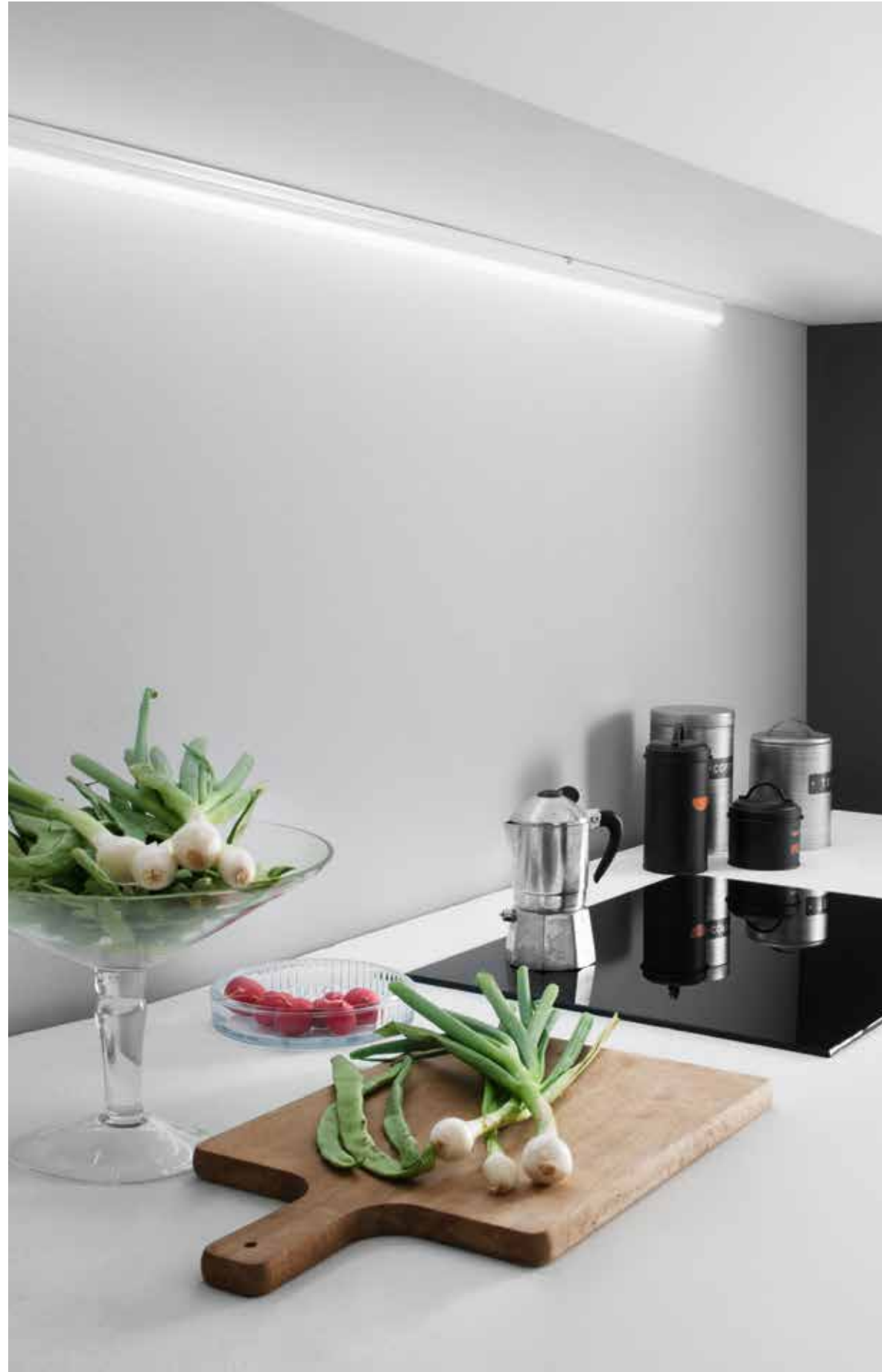
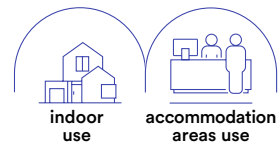

technical information **T5**



Optional installation: multiconnect
AC 100 - 240 V



	colour temp.	colour
LED BAR-T5-30	436 lm	5W
lumen		
watt		
beam angle	135°	

310 mm	23.9 mm
310 mm	35.4 mm

570 mm	23.9 mm
570 mm	35.4 mm

870 mm	23.9 mm
870 mm	35.4 mm

1170 mm	23.9 mm
1170 mm	35.4 mm

1484 mm	23.9 mm
1484 mm	35.4 mm

Accessori inclusi /
Included accessories



Staffe /
Brackets

SOTTOPENSILI E BARRE LED / CABINETS AND LEDBARS

In.tec light

MOVIE

Barra sottopensile orientabile
con struttura e diffusore in PC.
Adjustable cabinet bar with PC
structure and diffuser.

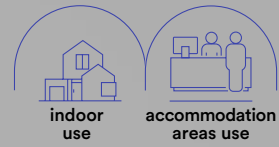

technical information **MOVIE**

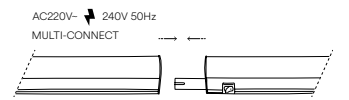

Materiale struttura in PC diffusore in PC	Material PC body with PC diffuser
Colore bianco	Colour white
Temperatura colore 4000K	Colour temperature 4000K
Temperatura colore selezionabile 2700K / 4000K / 6500K	Selectable color temperature 2700K / 4000K / 6500K
Interruttore incluso	Switch included
Driver integrato	Driver built-in



	colour temp.	colour		Accessori inclusi / Included accessories
LEDBAR-MOVIE-S 8031414866427	●	●	lumen 425 lm watt 5W beam angle 120° 348 mm 28.5 mm 66 mm	 Connettore / Connector
LEDBAR-MOVIE 8031440355100	● ● ● ●	● ● ● ●	lumen 800 lm watt 8W beam angle 120° 560 mm 25 mm 60 mm	 Connettore / Connector
LEDBAR-MOVIE-L 8031414866441	●	●	lumen 1275 lm watt 15W beam angle 120° 900 mm 28.5 mm 66 mm	 Connettore / Connector

LINE

Barra incasso sottopensile con struttura in alluminio e sensore di movimento.

Built-in bar under wall unit with aluminum structure and motion sensor

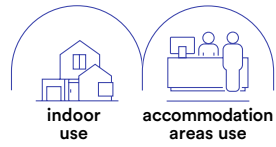

indoor use

accommodation areas use

Materiale
struttura in alluminio,
diffusore in PC
riflettente

Colore
bianco

Temperatura colore
4000K

Interruttore
sensore di movimento

Driver
non incluso DC12V

Material
aluminum body
with PC
reflective diffuser

Colour
white

Colour temperature
4000K

Swich
motion sensor

Driver
not included DC12V



technical information **LINE**



LEDBAR-LINE-91

8031414874286

lumen	500 lm
watt	9,5W
beam angle	120°
	905 × 16 x pr. 11 mm

colour temp. colour

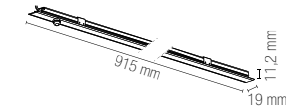

LEDBAR-LINE-127

8031414874279

lumen	710 lm
watt	13,5W
beam angle	120°
	1265 × 16 x pr. 11 mm

colour temp. colour

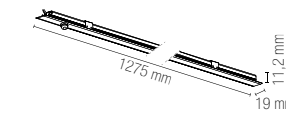

LEDBAR-LINE-199

8031414874309

lumen	1030 lm
watt	19,5W
beam angle	120°
	1985 × 16 x pr. 11 mm

colour temp. colour

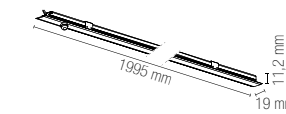

LEDBAR-LINE-223

8031414874293

lumen	1120 lm
watt	21W
beam angle	120°
	2225 × 16 x pr. 11 mm

colour temp. colour

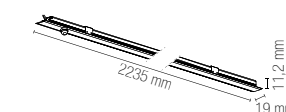

LED-DRIVER-LINE-33

8031414874262

Driver 33W 200-240V Dc12v 2.75A
Cavo 1m 2x0.75 mm con spina /
Driver 33W 200-240V Dc12v 2.75A
Cable 1m 2x0.75 mm with plug

140 × 47 × 25 mm

Driver con connettore multientrata max 3 barre MAX 33W /
Driver with multi connector max 3 bar MAX 33W



LED-DRIVER-LINE-54

8031414874255

Driver 54W 200-240V Dc12v 4.5A
Cavo 1m 2x0.75mm con spina /
Driver 54W 200-240V Dc12v 4.5A
Cable 1m 2x0.75mm with plug

152 × 59 × 32 mm

Driver con connettore multientrata max 3 barre MAX 54W /
Driver with multi connector max 3 bar MAX 54W



Accessori inclusi /
Included accessories

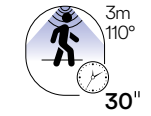

30"

Sensore di movimento regolabile /
Adjustable motion sensor



Staffe /
Brackets

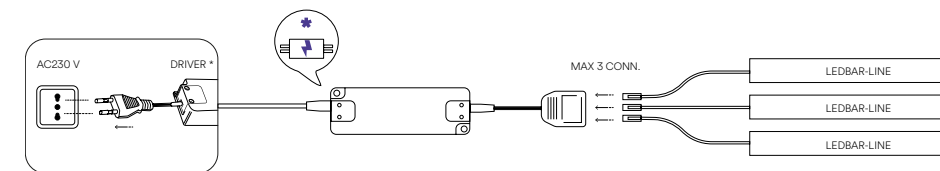

ZAK

Lampada LED con sensore IR.
IR sensor LED lamp.

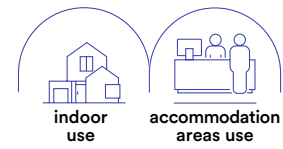

Materiale
struttura in alluminio,
diffusore in PC
riflettente

Colore
silver

Temperatura colore
3000K



Driver
non incluso DC12V

Material
aluminum body
with PC reflective
diffuser

Colour
silver

Colour temperature
3000K



Driver
not included DC12V



technical information **ZAK**

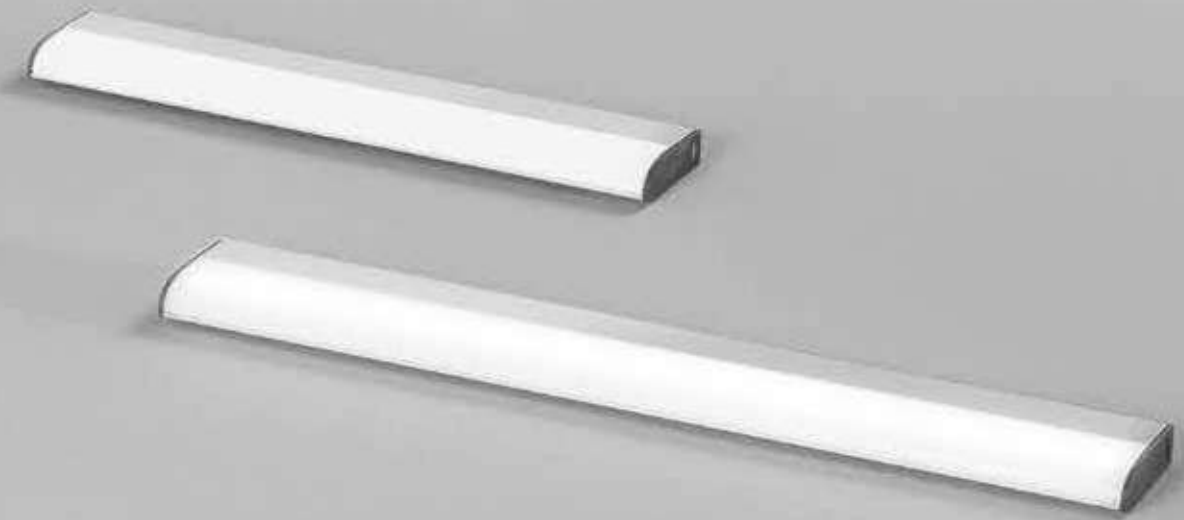

	colour temp.	colour	
LEDBAT-ZAK-IR26 8031414882281			
lumen	100 lm		261 mm
watt		1,20W	13,5 mm x 46 mm
beam angle		110°	
LEDBAT-ZAK-IR35 8031414882298			
lumen	150 lm		350 mm
watt		1,70W	13,5 mm x 46 mm
beam angle		110°	

Accessori inclusi / Included accessories

IR
Sensore 2 funzioni /
2 function sensor

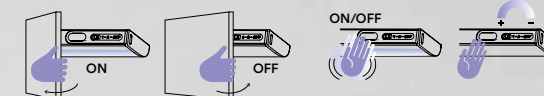

3.7V 1600mAh
Batteria ricaricabile inclusa /
Included rechargeable battery



DC5V 0,4A Micro USB
Cavo / Cable

GTO

Materiale
policarbonato

Colore
bianco

Temperatura colore
3000K

Material
policarbonato

Colour
white

Colour temperature
3000K

LED
SMD

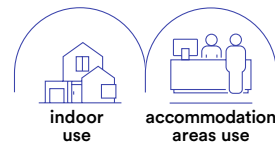

Lampada con sensore di movimento ricaricabile.
Rechargeable lamp with motion sensor.



LEDBAT-GTO
8031414882274

lumen 105 lm

watt 1W

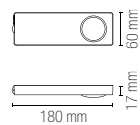

colour temp. colour



Accessori inclusi /
Included accessories

Sensore di movimento /
Motion sensor

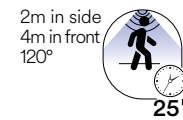

DC 3.7V 1A

Batteria ricaricabile /
Rechargeable battery



DC5V 0,4A Micro USB
Cavo / Cable



BLAM

Materiale
alluminio

Colore
struttura silver
diffusore bianco

Temperatura colore
3000K

Material
aluminum

Colour
silver structure
white diffuser

Colour temperature
3000K

LED
SMD

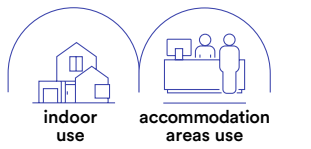

Lampada LED con sensore IR.
IR sensor LED lamp.



LEDBAT-BLAM-IR38
8031414882267

lumen 150 lm

watt 1,7W



colour temp. colour



Accessori inclusi /
Included accessories

IR
Sensore / Sensor

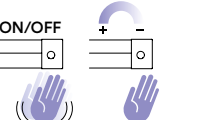

DC 3.7V 2.2A

Batteria ricaricabile /
Rechargeable battery



DC5V 0,4A Micro USB
Cavo / Cable

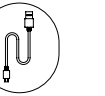

AURIKA

Materiale
policarbonato

Colore
bianco

Temperatura colore
3000K

Material
policarbonato

Colour
white

Colour temperature
3000K

LED
SMD



Lampada LED con sensore IR.
IR sensor LED lamp.



LEDBAT-AURIKA
8031414882250

lumen 100 lm

watt 1,25W

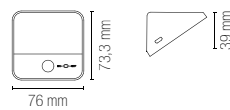

colour temp. colour



Accessori inclusi /
Included accessories

IR
Sensore / sensor



DC 3.7V 2.2A

Batteria ricaricabile /
Rechargeable battery



DC5V 0,4A Micro USB
Cavo / Cable

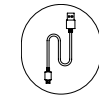

CLOSET

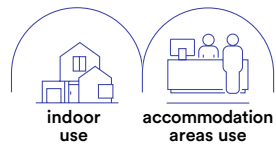

Materiale
policarbonato

Colore
silver

Temperatura colore
4000K

Material
policarbonato

Colour
silver

Colour temperature
4000K



Lampada con sensore di movimento.
Lamp with motion sensor.

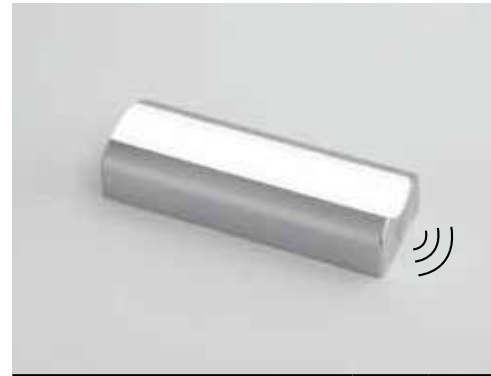

LED-CLOSET-10
8031414873012

lumen

105 lm

watt

1W

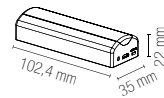

colour temp. | colour



Accessori inclusi /
Included accessories

Sensore di movimento /
Motion sensor

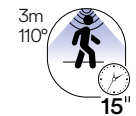

DC 5V 1A

Batteria ricaricabile /
Rechargeable battery



Micro USB charging wires DC 5V
Cavo non incluso / Not included cable

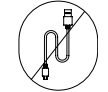

SHELF

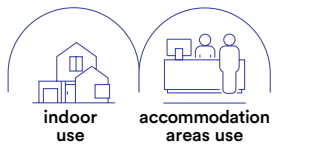

Materiale
policarbonato

Colore
struttura silver
diffusore bianco

Temperatura colore
4000K

Material
policarbonato

Colour
silver structure
white diffuser

Colour temperature
4000K



Lampada con sensore di movimento.
Lamp with motion sensor.



LED-SHELF-R7
8031414873029

lumen

110 lm

watt

1W



colour temp. | colour



Accessori inclusi /
Included accessories

Sensore di movimento /
Motion sensor

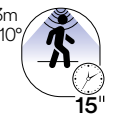

DC 5V 1A

Batteria ricaricabile /
Rechargeable battery



Micro USB charging wires DC 5V
Cavo non incluso / Not included cable

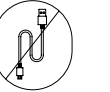

TRIGGER

Materiale
policarbonato

Colore
silver

Temperatura colore
4000K

Material
policarbonato

Colour
silver

Colour temperature
4000K



Kit 2pz. copri cerniera.
Kit 2pz. hinge cover.



LED-TRIGGER
8031414873005

watt

0,2W DC12V



colour temp. | colour



Accessorio non incluso /
Not included accessory

2x23A
Batteria / Battery



Compatibile per cerniera a scatto collo "0" /
Compatibe with "0" neck snap hinge

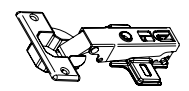

SONAR

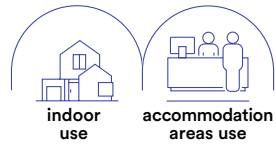

Materiale
policarbonato

Colore
silver

Temperatura colore
4500K

Material
polycarbonate

Colour
silver

Colour temperature
4500K

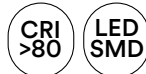

Barra sottopensile con sensore di movimento.
Cabinet bar with motion sensor.



LED-SONAR-AP
8031440021272

lumen 35 lm

watt 6 × 0,45W
beam angle 45°

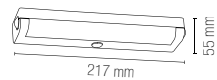

colour temp. | colour



Accessori inclusi /
Included accessories

Sensore di movimento regolabile /
Adjustable motion sensor

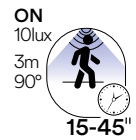

3×1,5V AAA
Batteria non inclusa / not included battery



VISTA

Materiale
policarbonato

Colore
bianco
silver

Temperatura colore
4500K / 6000K

Material
polycarbonate

Colour
white
silver

Colour temperature
4500K / 6000K



Lampada LED con sensore di movimento in bianco.
LED lamp with motion sensor in white.



LED-VISTA-M-AP
8031440031271

lumen 18 lm

watt 3 × 0,075W
beam angle 68° ↑
beam angle 88° ↓

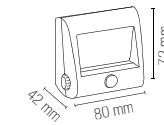

colour temp. | colour



Accessori inclusi /
Included accessories

Sensore di movimento /
Motion sensor

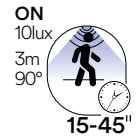

3×1,5V AAA
Batteria ricaricabile /
Rechargeable battery



YOUNG

Materiale
alluminio
silver

Temperatura colore
4000K

Driver
incluso

Material
aluminum
silver

Colour temperature
4000K

Driver
included



Barra sottile sottopensile con interruttore ottico.
Thin bar under cabinet with optical switch.



LED-YOUNG-5W
8031440071277

lumen 320 lm

watt 4,9W
beam angle 120°

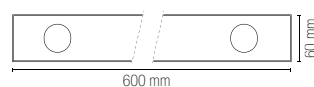

colour temp. | colour



Accessori inclusi /
Included accessories

x1 alimentatore
con cavo 2 m /
x1 power supply with
2 m cable included



Lampada LED con sensore di movimento in silver.
LED lamp with motion sensor in silver.



LED-VISTA-AP
8031439991272

lumen 20 lm

watt 3 × 0,075W

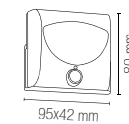

colour temp. | colour



Accessori inclusi /
Included accessories

Sensore di movimento /
Motion sensor

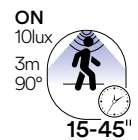

3×1,5V AAA
Batteria ricaricabile /
Rechargeable battery





PROFILI E STRIP LED

PROFILES AND STRIP LED



Profili in alluminio per fissaggio nel cartongesso.
Aluminum fixing profile in plasteboard.



I-PROFILO-GORIZIA-XL
8031414871094

Profilo 2 m a rapido fissaggio nel cartongesso, diffusore opale e tappi inclusi.

2 m quick fixing profile in plasteboard with opal diffuser and caps included.

colour

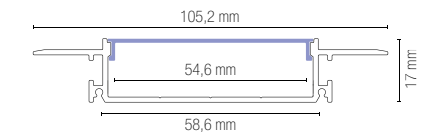

Accessori / Accessories

I-PROFILO-GORIZIA-XL-CAP
8031414890514

Kit 2 pz tappi di chiusura per profilo GORIZIA-XL.

2 pcs kit caps for GORIZIA-XL profile.

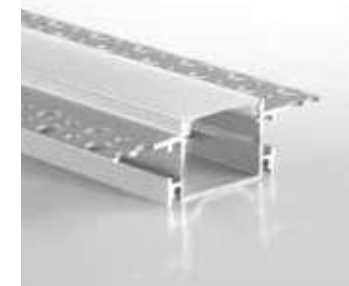

I-PROFILO-GORIZIA
8031414871124

Profilo 2 m a rapido fissaggio nel cartongesso, diffusore opale e tappi inclusi.

2 m quick fixing profile in plasteboard with opal diffuser and caps included.

colour

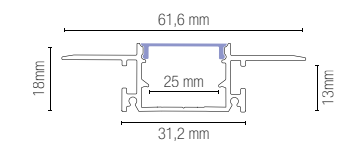

Accessori / Accessories

I-PROFILO-GORIZIA-CAP
8031414890484

Kit 2 pz tappi di chiusura per profilo GORIZIA.

2 pcs kit caps for GORIZIA profile.

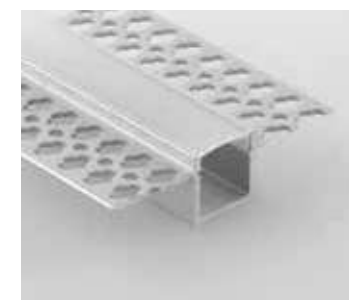

I-PROFILO-GORIZIA-S
8031414876587

Profilo 2 m a rapido fissaggio nel cartongesso, diffusore opale e tappi inclusi.

2 m quick fixing profile in plasteboard with opal diffuser and caps included.

colour

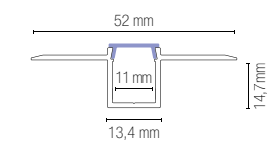

Accessori / Accessories

I-PROFILO-GORIZIA-S-CAP
8031414890491

Kit 2 pz tappi di chiusura per profilo GORIZIA-S.

2 pcs kit caps for GORIZIA-S profile.



I-PROFILO-GORIZIA-S-NER
8031414876624

Profilo 2 m di colore nero opaco a rapido fissaggio nel cartongesso, diffusore nero traslucido e tappi inclusi.

2 m quick fixing profile in plasteboard matt black with translucent black diffuser and caps included.

colour



Accessori / Accessories

I-PROFILO-GORIZIA-S-NER-CAP
8031414890507

Kit 2 pz tappi di chiusura per profilo GORIZIA-S nero.

2 pcs kit caps for GORIZIA-S black profile.

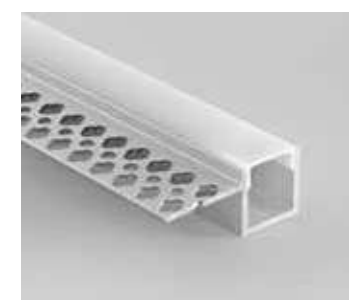

I-PROFILO-EDGE
8031414897575

Profilo 2 m a rapido fissaggio nel cartongesso, diffusore opale e tappi inclusi.

2 m quick fixing profile in plasteboard with opal diffuser and caps included.

colour

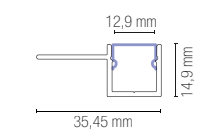

Accessori / Accessories

I-PROFILO-EDGE-CAP
8031414897582

Kit 2 pz tappi di chiusura per profilo EDGE.

2 pcs kit caps for EDGE profile.

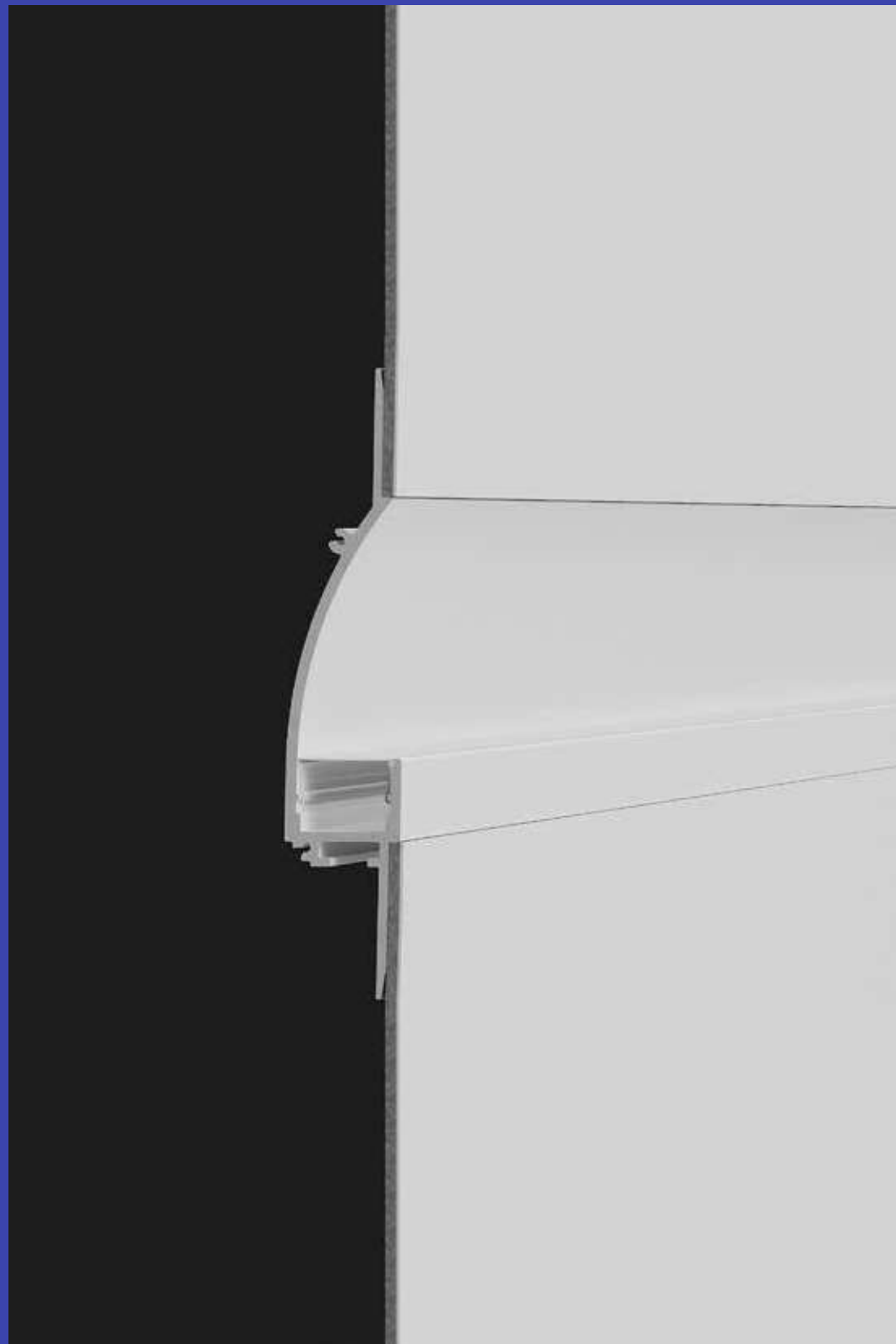

Profili in alluminio per fissaggio nel cartongesso.
Aluminum fixing profile in plasteboard.



I-PROFILO-RIDGE-2
8031414876570

Profilo 2 m angolare a rapido fissaggio nel cartongesso diffusore opale tappi e staffe inclusi.

2 m quick fixing angular profile in plasteboard with opal diffuser and caps included.

colour

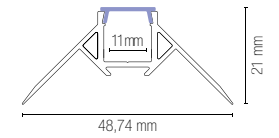

Accessori / Accessories
I-PROFILO-RIDGE-CAP
8031414890552

Kit 2 pz tappi di chiusura per profilo RIDGE.

2 pcs kit caps for RIDGE profile.



I-PROFILO-TRIM-2
8031414876563

Profilo 2 m a veletta bianco diffusore opale incluso.

2 m profile in white colour plasterboard veil with opal diffuser included.

colour

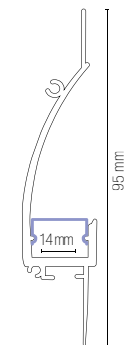

Accessori / Accessories
I-PROFILO-TRIM-CAP
8031414890583

Kit 2 pz tappi di chiusura per profilo TRIM.

2 pcs kit caps for TRIM profile.



I-PROFILO-MOP
8031414890019

Profilo 2 m a veletta bianco diffusore opale e 2 tappi inclusi.

2 m white veil profile, opal diffuser and 2 caps included.

colour

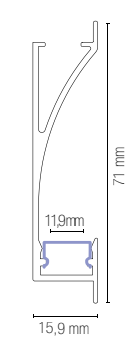

Accessori / Accessories
I-PROFILO-MOP
8031414888733

Kit 2 pz tappi di chiusura per profilo MOP.

2 pcs kit caps for MOP profile.



I-PROFILO-GASH
8031414890262

Profilo 2 m a veletta bianco diffusore opale e 2 tappi inclusi.

2 m white veil profile, opal diffuser and 2 caps included.

colour

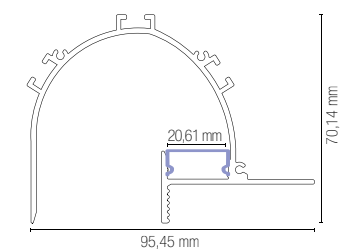

Accessori / Accessories
I-PROFILO-GASH-STL
8031414889990

Kit 2 pz staffe per profilo GASH incluso viti.

2 pcs kit brackets for GASH profile with included screws.

I-PROFILO-GASH-STZ
8031414890286

Kit 2 pz staffe per profilo GASH incluso viti.

2 pcs kit brackets for GASH profile with included screws.

Profili in alluminio.
Aluminum profile.

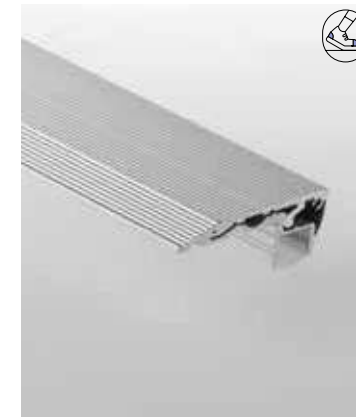

I-PROFILO-STEPWAY
8031414876594

Profilo 2 m per gradini,
diffusore opale, tappi inclusi.

2 m profile for step with
opal diffuser included.

colour

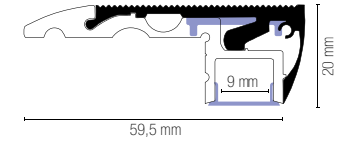

Accessori / Accessories

I-PROFILO-STEPWAY-CAP
8031414877782

Kit 2 pz tappi di chiusura
per profilo STEPWAY.

2 pcs kit caps for
STEPWAY profile.



I-PROFILO-DRIVEWAY-2
8031414881949

Profilo in alluminio silver
carrabile DRIVEWAY 2 m
incluso tappi e staffe.
(max 2000Kg)

Walkable 2 m profile
with opal diffuser included.
(max 2000Kg)

colour

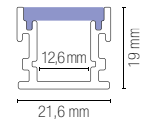

Accessori / Accessories

I-PROFILO-DRIVEWAY-CAP
8031414881956

Tappi per profilo in alluminio
silver carrabile DRIVEWAY silver.

2 pcs kit caps for
DRIVEWAY profile.

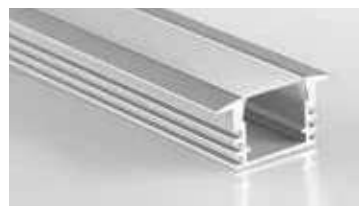

I-PROFILO-BERLINO
8031434611212

Profilo 1 m a rapido fissaggio nel cartongesso, diffusore opale, tappi e staffe inclusi.

1 m quick fixing profile in plasteboard with opal diffuser caps and bracket included.

colour

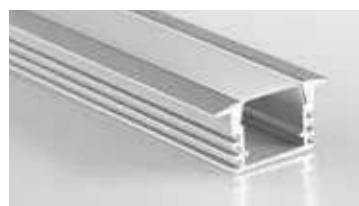
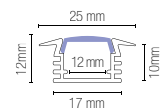

I-PROFILO-BERLINO-2
8031440359405

Profilo 2 m a rapido fissaggio nel cartongesso, diffusore opale, tappi e staffe inclusi.

2 m quick fixing profile in plasteboard with opal diffuser caps and bracket included.

colour

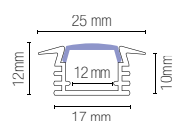

Accessori / Accessories

I-PROFILO-BERLINO-CAP
8031414890446

Kit 2 pz tappi di chiusura per profilo BERLINO.

2 pcs kit caps for BERLINO profile.



I-PROFILO-BERLINO-2 BCO
8031414871070

Profilo bianco 2 m a rapido fissaggio nel cartongesso, diffusore opale, tappi e staffe inclusi.

2 m quick fixing profile in plasteboard white colour with opal diffuser caps and bracket included.

colour



Accessori / Accessories

I-PROFILO-BERLINO-BCO-CAP
8031414890453

Kit 2 pz tappi di chiusura per profilo BERLINO bianco.

2 pcs kit caps for BERLINO white profile.



I-PROFILO-BERLINO-2 NER
8031414876617

Profilo 2 m nero opaco a rapido fissaggio nel cartongesso, diffusore nero traslucido, tappi e staffe incluse.

2 m quick fixing profile in plasterboard matt, translucent black diffuser, caps and brackets included.

colour



Accessori / Accessories

I-PROFILO-BERLINO-NER-CAP
8031414890460

Kit 2 pz tappi di chiusura per profilo BERLINO nero.

2 pcs kit caps for BERLINO black profile.

Accessori / Accessories

I-PROF-BERLINO2-DIFF
8031440357647

Diffusore 2 m trasparente per profili BERLINO.

2 m PC trasparent diffuser for BERLINO.



I-PROFILO-ROMA
8031434601213

Profilo 1 m a rapido fissaggio nel cartongesso o superfici esterne, diffusore opale, tappi e staffe inclusi.

1 m quick fixing profile in plasteboard or surface mount with opal diffuser caps and bracket included.

colour

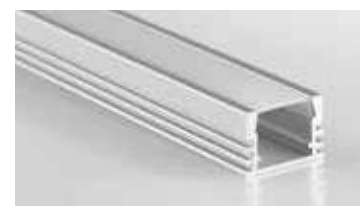
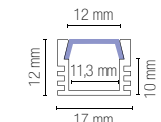

I-PROFILO-ROMA-2
8031440359399

Profilo 2 m a rapido fissaggio nel cartongesso o superfici esterne, diffusore opale, tappi e staffe inclusi.

2 m quick fixing profile in plasteboard or surface mount with opal diffuser caps and bracket included.

colour

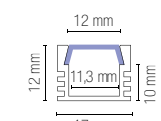

Accessori / Accessories

I-PROFILO-ROMA-CAP
8031414890569

Kit 2 pz tappi di chiusura per profilo ROMA.

2 pcs kit caps for ROMA profile.



I-PROFILO-ROMA-2 NER
8031414876600

Profilo 2 m nero opaco a rapido fissaggio nel cartongesso o superfici esterne, diffusore nero traslucido, tappi e staffe incluse.

2 m quick fixing profile in plasterboard or surface mount matt, translucent black diffuser, caps and brackets included.

colour



Accessori / Accessories

I-PROFILO-ROMA-NER-CAP
8031414890576

Kit 2 pz tappi di chiusura per profilo ROMA nero.

2 pcs kit caps for ROMA black profile.

I-PROF-ROMA2-DIFF
8031440357630

Diffusore 2 m trasparente per profili ROMA.

2 m PC trasparent diffuser for ROME.



Profili in alluminio.
Aluminum profile.



I-PROFILO-MICRO
8031414888740

Profilo 2 m a rapido fissaggio nel cartongesso o superfici esterne, diffusore opale, tappi e staffe inclusi.

2 m quick fixing profile in plasteboard or surface mount with opal diffuser caps and bracket included.

colour



Accessori / Accessories
I-PROFILO-MICRO-CAP
8031414888757

Kit 2 pz tappi di chiusura per profilo MICRO.

2 pcs kit caps for MICRO profile.



I-PROFILO-INCRO
8031414888764

Profilo 2 m a rapido fissaggio nel cartongesso o superfici esterne, diffusore opale, tappi e staffe inclusi.

2 m quick fixing profile in plasteboard or surface mount with opal diffuser caps and bracket included.

colour



Accessori / Accessories
I-PROFILO-INCRO-CAP
8031414888771

Kit 2 pz tappi di chiusura per profilo INCRO.

2 pcs kit caps for INCRO profile.



Profili in alluminio per installazione a muro/soffitto o sospensione.

Aluminum profile for wall/ceiling or suspension installation.



I-PROFILO-LOOP-2

8031414881840

Profilo 2 m in alluminio silver diffusore emissione a 180° incluso tappi e staffe.

2 m aluminum profile silver diffuser emission at 180° cups and brackets included.

colour

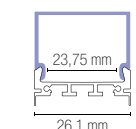

Accessori / Accessories

I-PROFILO-LOOP-CAP

8031414881857

Tappi per profilo in alluminio LOOP.

2 pcs kit caps for LOOP profile.



I-PROFILO-TUBE-2

8031414881925

Profilo 2 m in alluminio silver diffusore emissione a 180° incluso tappi e staffe.

2 m aluminum profile silver diffuser emission at 180° cups and brackets included.

colour

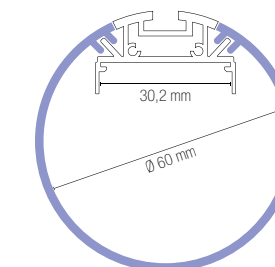

Accessori / Accessories

I-PROFILO-TUBE-CAP

8031414881932

Tappi per profilo tubolare ø 60 mm base in alluminio TUBE.

2 pcs kit caps for TUBE profile.

Accessori / Accessories

I-PROFILO-TUBE-SOSP

8031414882243

Kit cavi acciaio sospensione 2,5 m profilo tubolare TUBE.

Kit suspension mountig system.

Profili angolari in alluminio per installazione a muro/soffitto o sospensione.

Angular Aluminum profiles for wall/ceiling or suspension installation.



I-PROFILO-DORIK-2
8031414876556

Profilo 2 m con fissaggio a parete diffusore angolare opale tappi e staffe inclusi.

2 m profile surface mount with opal diffuser and caps included.

colour

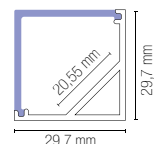

Accessori / Accessories

I-PROFILO-DORIK-CAP

803141487768

Kit 2 pz tappi di chiusura per profilo DORIK.

2 pcs kit caps for DORIK profile.



I-PROFILO-DORIK-16-2
8031414882205

Profilo in alluminio silver angolare DORIK 2 m incluso tappi e staffe.

2 m profile surface mount with opal diffuser and caps included.

colour

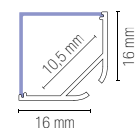

Accessori / Accessories

I-PROFILO-DORIK-16-CAP

8031414882212

Tappi per profilo in alluminio angolare DORIK 16x16 mm silver.

2 pcs kit caps for DORIK profile.



I-PROFILO-IONIK-2
8031414876549

Profilo 2 m con fissaggio a parete diffusore angolare opale, tappi e staffe inclusi.

2 m profile surface mount with opal diffuser and caps included.

colour

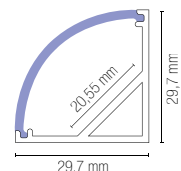

Accessori / Accessories

I-PROFILO-IONIK-CAP

803141487775

Kit 2 pz tappi di chiusura per profilo IONIK.

2 pcs kit caps for IONIK profile.



I-PROFILO-IONIK-16-2
8031414882229

Profilo in alluminio silver angolare IONIK 2 m incluso tappi e staffe.

2 m profile surface mount with opal diffuser and caps included.

colour

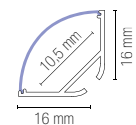

Accessori / Accessories

I-PROFILO-IONIK-16-CAP

8031414882236

Tappi per profilo in alluminio angolare IONIK 16x16 mm silver.

2 pcs kit caps for IONIK profile.



I-PROFILO-NEWYORK
8031434581218

Profilo angolare 1 m a rapido fissaggio nel cartongesso diffusore opale tappi e staffe inclusi.

1m quick fixing angular profile in plasteboard with opal diffuser caps and bracket included.

colour

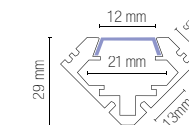

I-PROFILO-NEWYORK-2
8031440359382

Profilo angolare 2 m a rapido fissaggio nel cartongesso diffusore opale tappi e staffe inclusi.

2 m quick fixing angular profile in plasteboard with opal diffuser caps and bracket included.

colour

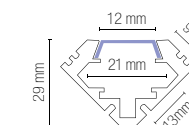

Accessori / Accessories

I-PROFILO-NEWYORK-CAP

8031414890545

Kit 2 pz tappi di chiusura per profilo NEWYORK.

2 pcs kit caps for NEWYORK profile.

Accessori / Accessories

I-PROF-NEWYORK2-DIFF

8031440357623

Diffusore 2 m trasparente profilo NEW YORK angolare alluminio.

2 m PC trasparente diffuser for NEW YORK.

Profili in alluminio.
Aluminum profile.



I-PROFILO-CAMELOT

8031414871087

Profilo flessibile 2 m
diffusore opale,
tappi e staffette inclusi.

Flexible profile 2 m
with opal diffuser
caps and bracket included.

colour

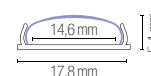

Accessori / Accessories

I-PROFILO-CAMELOT-CAP

8031414890477

Kit 2 pz tappi di chiusura
per profilo CAMELOT.

2 pcs kit caps for
CAMELOT profile.



I-PROFILO-ULTRA

8031414888788

Profilo 2 m con diffusore opale,
tappi e staffette inclusi.

2 m profile with opal diffuser,
caps and brackets included.

colour

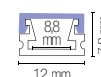

Accessori / Accessories

I-PROFILO-ULTRA-CAP

8031414890255

Kit 2 pz tappi di chiusura
per profilo ULTRA.

2 pcs kit caps
for ULTRA profile.



I-PROFILO-LINEA-2-BCO

8031414881963

Profilo in alluminio
bianco LINEA 2 m
incluso tappi e staffe.

2 m black profile with
opal diffuser, bracket
and caps included.

colour

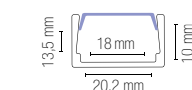

I-PROFILO-LINEA-BCO-CAP

8031414881970

Tappi per profilo in alluminio
LINEA bianco.

2 pcs kit caps
for LINEA profile.

I-PROFILO-LINEA-2-NER

8031414881987

Profilo in alluminio
nero LINEA 2 m
incluso tappi e staffe.

2 m black profile with
black diffuser, bracket
and caps included.

colour



Accessori / Accessories

I-PROFILO-LINEA-NER-CAP

8031414882199

Tappi per profilo in alluminio
LINEA nero.

2 black pcs kit caps
for LINEA profile.



I-PROFILO-MILANO

8031434611854

Profilo 1 m diffusore opale,
tappi e staffette inclusi.

Profile 1 m with opal diffuser,
caps and bracket included.

colour

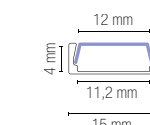

I-PROFILO-MILANO-2

8031440359412

Profilo 2 m diffusore opale,
tappi e staffette inclusi.

Profile 2m with opal diffuser,
caps and bracket included.

Accessori / Accessories

I-PROFILO-MILANO-CAP

8031414890538

Kit 2 pz tappi di chiusura
per profilo MILANO.

2 pcs kit caps for
MILANO profile.



I-PROFILO-MILANO-2 BCO

8031414871100

Profilo bianco 2 m diffusore opale,
tappi e staffette inclusi.

White profile 2 m with opal diffuser,
caps and bracket included.

colour



Accessori / Accessories

I-PROFILO-MILANO-BCO-CAP

8031414890521

Kit 2 pz tappi di chiusura
per profilo MILANO bianco.

2 pcs kit caps for
MILANO white profile.

Accessori / Accessories

I-PROF-MILANO2-DIFF

8031440357654

Diffusore 2 m trasparente profilo
MILANO alluminio.

2 m PC trasparent diffuser
for MILANO.

Profili in alluminio.
Aluminum profile.



I-PROFILO-DUAL-2-BCO
8031414881864

Profilo in alluminio bianco doppia emissione 2 m incluso tappi e staffe. 2 m biemission profile.

colour

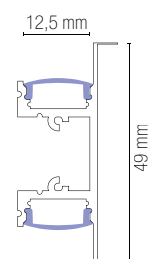

Accessori / Accessories

I-PROFILO-DUAL-BCO-CAP
8031414881871

Tappi per profilo in alluminio DUAL doppia emissione bianco. 2 pcs kit caps for DUAL profile.



I-PROFILO-DUAL-2-NER
8031414881888

Profilo in alluminio nero doppia emissione 2 m incluso tappi e staffe. 2 m black biemission profile.

colour



Accessori / Accessories

I-PROFILO-DUAL-NER-CAP
8031414881895

Tappi per profilo in alluminio DUAL doppia emissione nero. 2 black pcs kit caps for DUAL profile.



I-PROFILO-VEIL-2
8031414881901

Profilo in alluminio bianco a veletta singola emissione 2 m incluso tappi e staffe. 2 m single emission white aluminum profile caps and brackets included.

colour

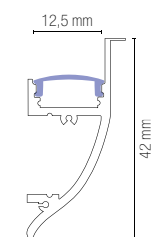

Accessori / Accessories

I-PROFILO-VEIL-CAP
8031414881918

Tappi per profilo in alluminio VEIL a veletta singola emissione bianco. 2 pcs kit caps for VEIL profile.



I-PROFILO-PIANO-2
8031414878802

Profilo base per dissipazione strip colore silver 2 m. 2 m profile dissipation base silver colour.

colour

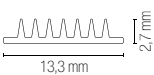

Accessori per barre LED.
LED bar accessories.

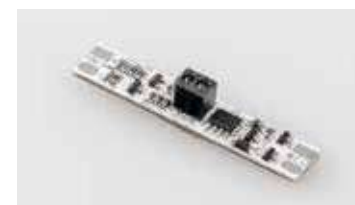

STRIP-HANDSENSOR-W
8031414879335

Scheda rilevatore movimento mano per strip singolo colore input DC12V-24V output DC12V-24V 60/120W 5A max.

Hand motion card for single color strip DC12V-24V output DC12V-24V 60/120W 5A max.

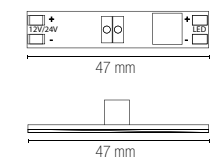

Funzioni sensore interruttore
Raggio di rilevamento 5-15 cm

Motion sensor switch
Detection range 5-15 cm



STRIP-PIRESENSOR
8031414879373

Scheda sensore movimento pir per strip Input DC12V-24V output DC12V-24V 60/120W 5A max.

Pir motion sensor card for strip DC12V-24V output DC12V-24V 60/120W 5A max.

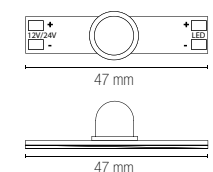

Funzioni sensore movimento

Motion sensor function

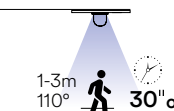

STRIP-TOUCH-W
8031414879359

Scheda pulsante touch per strip singolo colore input DC12V-24V output DC12V-24V 60/120W 5A max.

Touch button card for single color strip DC12V-24V output DC12V-24V 60/120W 5A max.

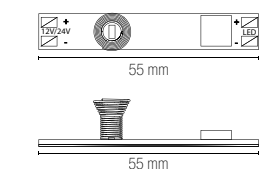

Funzioni sensore touch

Passando sul sensore entro i 0,5 secondi si attiva la funzione ON/OFF

Touch sensor function

When touching the sensor within 0,5 second the switch status changes ON/OFF

Restando sul sensore oltre i 0,5 secondi si attiva la funzione di regolazione di intensità luminosa (massima - minima - massima)

When touching the sensor for over 0,5 second the switch turn to adjustment status (high - low - high)



I-PROFILO-INC-STAFFE
8031414890002

Molla per incasso adatto per profili MILANO/ROMA/BERLINO, kit 2 pz

Metal spring for profile MILANO/ROMA/BERLINO, 2pcs kit

Profili in gesso verniciabile per dare omogeneità tra parete e corpo illuminante.
 Paintable gypsum profile to give homogeneity between the wall and the lighting body.



I-PROFY-BIS
8031414882359

Profilo in gesso per led biemissione, incluso anima alluminio e diffusori in PC / Gypsum profile for led double emission including PC cover and aluminum

Diffusori in PC / PC-diffuser
1000 × 61 × 41 mm

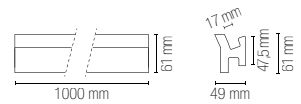

I-PROFY-BIS-L
8031414882380

Angolo L per profilo in gesso per led biemissione incluso anima alluminio e diffusori in PC / Gypsum corner profile including PC cover and aluminum

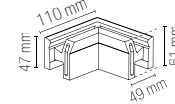

I-PROFY-GIMEL
8031414882410

Profilo in gesso per led singola emissione, anima alluminio e diffusore in PC / Gypsum profile for led single emission including PC cover and aluminum

Diffusori in PC / PC-diffuser
1000 × 61 × 41 mm

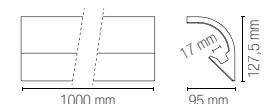

I-PROFY-GIMEL-L
8031414882427

Angolo L per profilo in gesso per led, singola emissione, anima alluminio e diffusore in PC / Gypsum corner profile including PC cover and aluminum

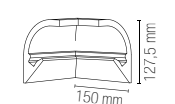

I-PROFY-MONO
8031414882366

Profilo in gesso per led singola emissione, angolo 90° anima alluminio e diffusore in PC / Gypsum profile for LED single emission including PC cover and aluminum

Diffusori in PC / PC-diffuser
1000 × 61 × 41 mm

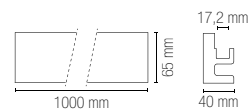

I-PROFY-MONO-L
8031414882397

Angolo L per profilo in gesso per led singola emissione, angolo 90°, anima alluminio e diffusore in PC / Gypsum corner profile including PC cover and aluminum

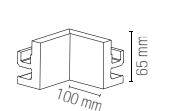

I-PROFY-VELA
8031414882373

Angolo L per profilo in gesso per led singola emissione, anima alluminio e diffusore in PC / Gypsum corner for led single emission including PC cover and aluminum

Diffusori in PC / PC-diffuser
1000 × 61 × 41 mm

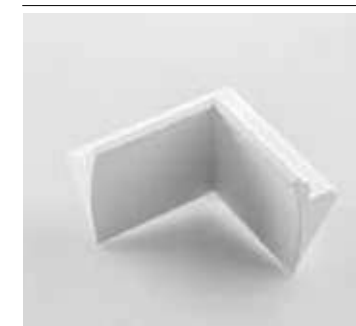
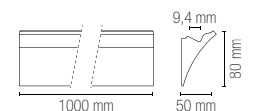

I-PROFY-VELA-L
8031414882403

Angolo L per profilo in gesso per led, singola emissione, anima alluminio e diffusore in PC / Gypsum corner profile including PC cover and aluminum

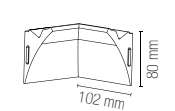

STRIP

Rotolo 5 metri strip led.
Roll 5 meters strip-led.

EASY
DOMOTICA



Driver p. 837-846
Controller p. 848-851



Materiale kapton senza silicone	Material kapton without silicone
Temperatura colore 3000K / 4000K / 6000K	Colour temperature 3000K / 4000K / 6000K
Driver DC24V tensione costante non incluso	Driver DC24V constant voltage not included
Durata e on/off 50.000h >25.000 on/off	Life time and on/off 50.000h >25.000 on/off

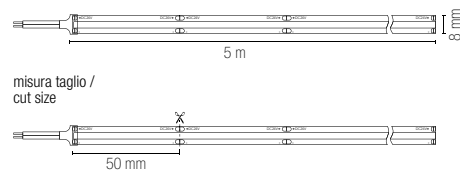
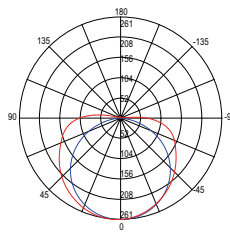

	colour temp.
STRIP24V-COB-480C 8031414881697 lumen/m total lumen	1538 lm 7690 lm
STRIP24V-COB-480M 8031414883516 lumen/m total lumen	1700 lm 8500 lm
STRIP24V-COB-480F 8031414881703 lumen/m total lumen	1698 lm 8490 lm
light source	LED COB 480
watt/m	15W

Rotolo 5 metri strip led.
Roll 5 meters strip-led.

EASY
DOMOTICA



Driver p. 837-846
Controller p. 848-851



Materiale kapton con silicone	Material kapton with silicone
Temperatura colore 3000K / 4000K / 6000K	Colour temperature 3000K / 4000K / 6000K
Driver DC24V tensione costante non incluso	Driver DC24V constant voltage not included
Durata e on/off 50.000h >25.000 on/off	Life time and on/off 50.000h >25.000 on/off

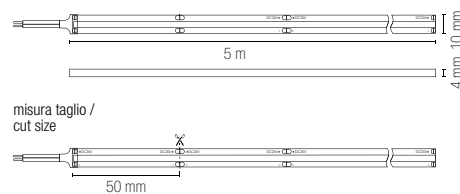
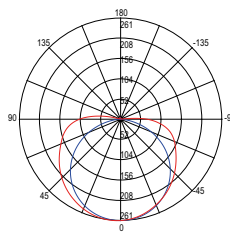

	colour temp.
STRIP24V-COB-IP67-480C 8031414881710 lumen/m total lumen	1538 lm 7690 lm
STRIP24V-COB-IP67-480M 8031414881727 lumen/m total lumen	1700 lm 8500 lm
STRIP24V-COB-IP67-480F 8031414881734 lumen/m total lumen	1698 lm 8490 lm
light source	LED COB 480
watt/m	15W

STRIP

Rotolo 30 metri strip led.
Roll 30 meters strip-led.

EASY
DOMOTICA



Driver p. 837-846
Controller p. 848-851



Materiale kapton senza silicone	Material kapton without silicone
Temperatura colore 3000K / 4000K / 5000K	Colour temperature 3000K / 4000K / 5000K
Driver DC36V tensione costante non incluso	Driver DC36V constant voltage not included
Durata e on/off 25.000h >15.000 on/off	Life time and on/off 25.000h >15.000 on/off

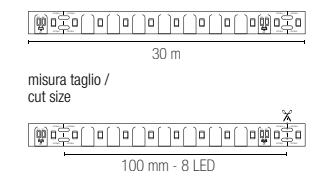
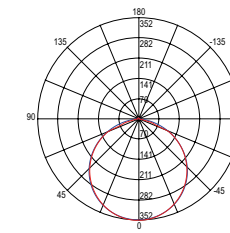

	colour temp.
STRIPLED-CC30-C 8031414864409 lumen	720 lm/m
STRIPLED-CC30-M 8031414864379 lumen	720 lm/m
STRIPLED-CC30-F 8031414864386 lumen	720 lm/m
light source	SMD 2835
watt/m	7,2W
led/m	90

Rotolo 5 metri strip led.
Roll 5 meters strip-led.

EASY
DOMOTICA



Driver p. 837-846
Controller p. 848-851

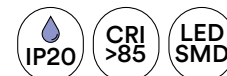

Materiale kapton senza silicone	Material kapton without silicone
Temperatura colore 3000K / 4000K / 6000K	Colour temperature 3000K / 4000K / 6000K
Driver DC24V tensione costante non incluso	Driver DC24V constant voltage not included
Durata e on/off 50.000h >25.000 on/off	Life time and on/off 50.000h >25.000 on/off

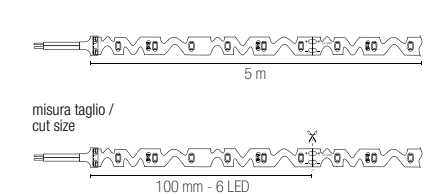
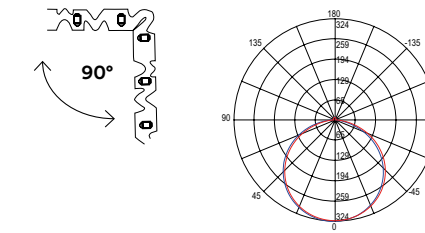

	colour temp.
STRIP24V-2835-3D-60C 8031414878765 lumen/m total lumen	1542 lm 7710 lm
STRIP24V-2835-3D-60M 8031414878727 lumen/m total lumen	1480 lm 7400 lm
STRIP24V-2835-3D-60F 8031414878628 lumen/m total lumen	1542 lm 7710 lm
light source	SMD 2835
watt/m	12W
led/m	60

STRIP

Rotolo 5 metri strip led.
Roll 5 meters strip-led.



EASY DOMOTICA



Driver p. 837-846
Controller p. 848-851



Materiale kapton senza silicone	Material kapton without silicone
Temperatura colore 3000K / 4000K / 6000K	Colour temperature 3000K / 4000K / 6000K
Driver DC24V tensione costante non incluso	Driver DC24V constant voltage not included
Durata e on/off 50.000h >25.000 on/off	Life time and on/off 50.000h >25.000 on/off

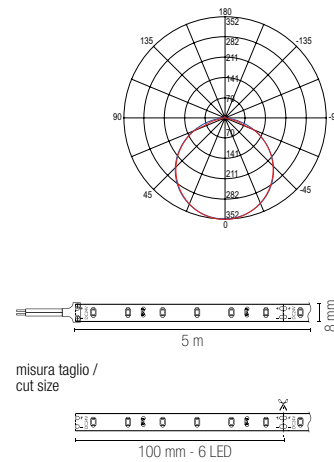

STRIP24V-2835-60C 8031414871278	colour temp. 1542 lm
lumen/m	7710 lm
STRIP24V-2835-60M 8031414871285	1480 lm
lumen/m	7400 lm
STRIP24V-2835-60F 8031414871292	1542 lm
lumen/m	7710 lm
total lumen	
light source	SMD 2835
watt/m	12W
led/m	60

STRIP

Rotolo 5 metri strip led ultrasottile.
Roll 5 meters ultra-thin strip-led.

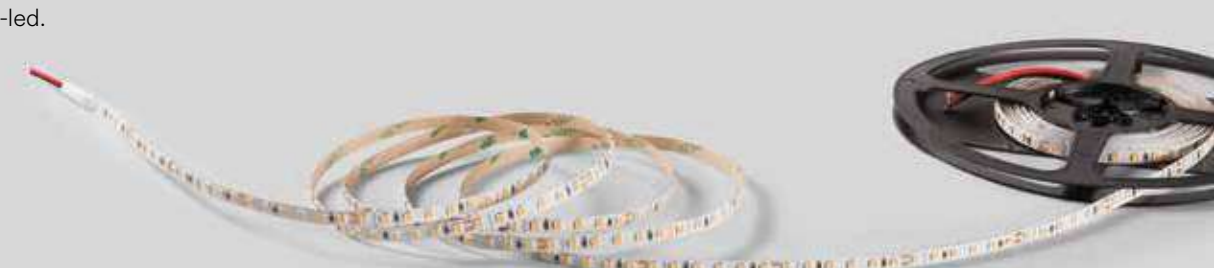

EASY DOMOTICA



Driver p. 837-846
Controller p. 848-851



Materiale kapton senza silicone	Material kapton without silicone
Temperatura colore 3000K / 4000K / 6000K	Colour temperature 3000K / 4000K / 6000K
Driver DC24V tensione costante non incluso	Driver DC24V constant voltage not included
Durata e on/off 25.000h >15.000 on/off	Life time and on/off 25.000h >15.000 on/off

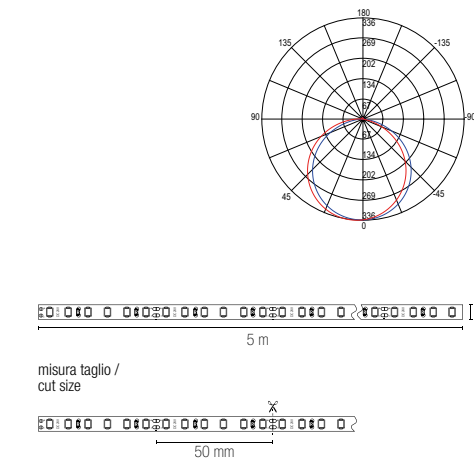

STRIP24V-SLIM-120C 8031414881741	colour temp. 1896 lm
lumen/m	9480 lm
STRIP24V-SLIM-120M 8031414881758	1838 lm
lumen/m	9190 lm
STRIP24V-SLIM-120F 8031414881765	1766 lm
lumen/m	8830 lm
total lumen	
light source	SMD 2835
watt/m	18W
led/m	120

Rotolo 5 metri strip led.
Roll 5 meters strip-led.



EASY DOMOTICA



Driver p. 837-846
Controller p. 848-851

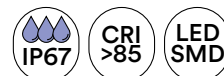

Materiale kapton con rivestimento in silicone	Material kapton with silicone cover
Temperatura colore 3000K / 4000K / 6000K	Colour temperature 3000K / 4000K / 6000K
Driver DC24V tensione costante non incluso	Driver DC24V constant voltage not included
Durata e on/off 50.000h >25.000 on/off	Life time and on/off 50.000h >25.000 on/off

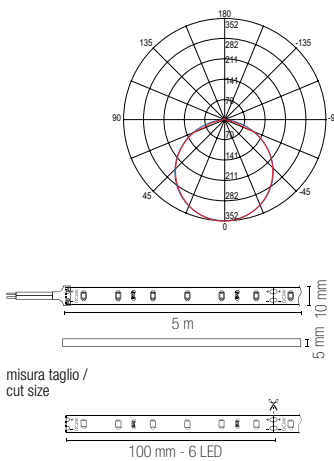

STRIP24V-2835IP67-60C 8031414871308	colour temp. 1542 lm
lumen/m	7710 lm
STRIP24V-2835IP67-60M 8031414871315	1480 lm
lumen/m	7400 lm
STRIP24V-2835IP67-60F 8031414871322	1542 lm
lumen/m	7710 lm
total lumen	
light source	SMD 2835
watt/m	12W
led/m	60

Rotolo 5 metri strip led.
Roll 5 meters strip-led.



EASY DOMOTICA



Driver p. 837-846
Controller p. 848-851



Materiale kapton senza silicone	Material kapton without silicone
Temperatura colore 3000K/4000K/6000K/BLU	Colour temperature 3000K/4000K/6000K/BLU
Driver DC24V tensione costante non incluso	Driver DC24V constant voltage not included
Durata e on/off 50.000h >25.000 on/off	Life time and on/off 50.000h >25.000 on/off

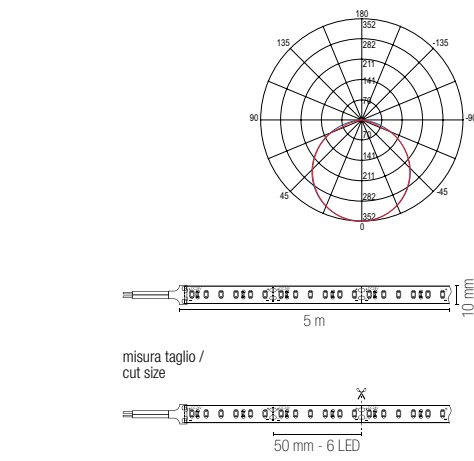

STRIP24V-2835-120C 8031414871056	colour temp. 2342 lm
lumen/m	11710 lm
STRIP24V-2835-120M 8031414871063	2280 lm
lumen/m	11400 lm
STRIP24V-2835-120F 8031414871032	2258 lm
lumen/m	11290 lm
total lumen	
STRIP24V-2835-120BLU 8031414871049	BLU
lumen	
light source	SMD 2835
watt/m	18W
led/m	120

STRIP

Rotolo 5 metri strip led.
Roll 5 meters strip-led.



EASY DOMOTICA



Driver p. 837-846
Controller p. 848-851

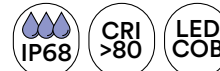

Materiale kapton con silicone	Material kapton with silicone
Temperatura colore 6000K	Colour temperature 6000K
Driver DC24V tensione costante non incluso	Driver DC24V constant voltage not included
Durata e on/off 50.000h >25.000 on/off	Life time and on/off 50.000h >25.000 on/off

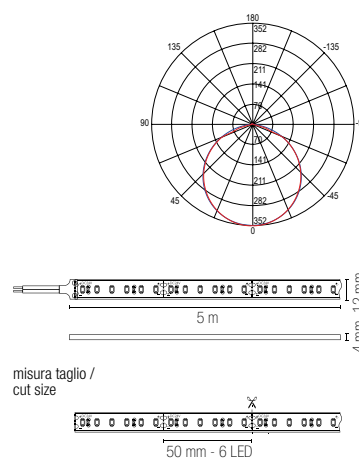

STRIP24V-2835IP68-120F
8031414881772
lumen/m
total lumen

colour temp.	2258 lm
	11290 lm

light source	LED COB 120
watt/m	18W
led/m	120

STRIP

Rotolo 5 metri strip led.
Roll 5 meters strip-led.



EASY DOMOTICA



Driver p. 837-846
Controller p. 848-851



Materiale kapton senza silicone	Material kapton without silicone
Temperatura colore 3000K / 4000K / 6000K	Colour temperature 3000K / 4000K / 6000K
Driver DC24V tensione costante non incluso	Driver DC24V constant voltage not included
Durata e on/off 50.000h >25.000 on/off	Life time and on/off 50.000h >25.000 on/off

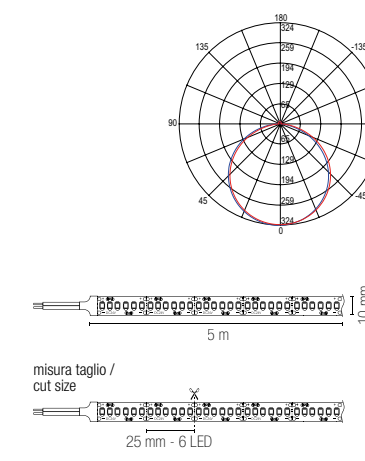

STRIP24V-2835-240C
8031414871018
lumen/m
total lumen

colour temp.	2706 lm
	13530 lm

STRIP24V-2835-240M 8031414871025 lumen/m total lumen	2640 lm 13200 lm
STRIP24V-2835-240F 8031414871001 lumen/m total lumen	2526 lm 12630 lm
light source	SMD 2835
watt/m	24W
led/m	240

Rotolo 5 metri strip led.
Roll 5 meters strip-led.



EASY DOMOTICA



Driver p. 837-846
Controller p. 848-851



Materiale kapton senza silicone	Material kapton without silicone
Temperatura colore CCT	Colour temperature CCT
Driver DC24V tensione costante non incluso	Driver DC24V constant voltage not included
Durata e on/off 50.000h >25.000 on/off	Life time and on/off 50.000h >25.000 on/off

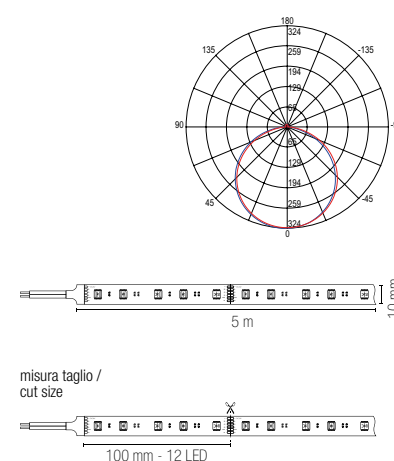

STRIP24V-2835-CCT
8031414875795
lumen/m
total lumen

colour temp.	2652 lm
	13260 lm

light source	SMD 2835
watt/m	24W
led/m	120

Rotolo 5 metri strip led.
Roll 5 meters strip-led.



EASY DOMOTICA



Driver p. 837-846
Controller p. 848-851



Materiale kapton senza silicone	Material kapton without silicone
Temperatura colore 3000K / 4000K / 6000K	Colour temperature 3000K / 4000K / 6000K
Driver DC24V tensione costante non incluso	Driver DC24V constant voltage not included
Durata e on/off 50.000h >25.000 on/off	Life time and on/off 50.000h >25.000 on/off

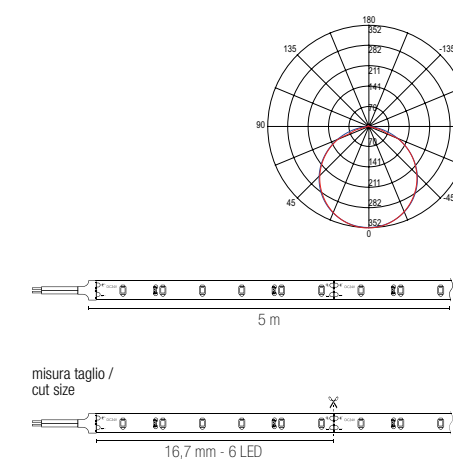

STRIP24V-5050-60C
8031414878420
lumen/m
total lumen

colour temp.	1390 lm
	6950 lm

STRIP24V-5050-60M 8031414878741 lumen/m total lumen	1430 lm 7150 lm
STRIP24V-5050-60F 8031414876129 lumen/m total lumen	1314 lm 6570 lm
light source	SMD 5050
watt/m	14,4W
led/m	60

STRIP

Rotolo 5 metri strip led.
Roll 5 meters strip-led.

EASY
DOMOTICA



Driver p. 837-846
Controller p. 848-851



Materiale
kapton con rivestimento in silicone

Material
kapton with silicone cover

Temperatura colore
3000K / 4000K / 6000K



Colour temperature
3000K / 4000K / 6000K



Driver
DC24V
tensione costante non incluso

Driver
DC24V
constant voltage not included

Durata e on/off
50.000h
>25.000 on/off

Life time and on/off
50.000h
>25.000 on/off

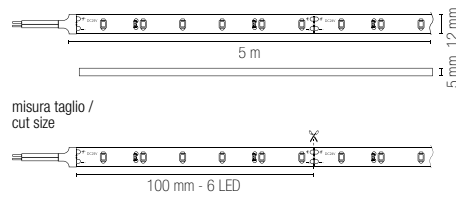
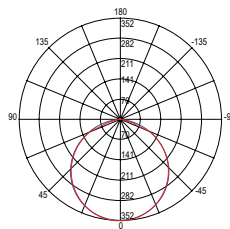

STRIP24V-5050IP67-60C

8031414876143
lumen/m
total lumen

colour temp.
1390 lm
6950 lm

STRIP24V-5050IP67-60M

8031414876150
lumen/m
total lumen

1430 lm
7150 lm

STRIP24V-5050IP67-60F

8031414876174
lumen/m
total lumen

1314 lm
6570 lm

light source SMD 5050
watt/m 14,4W
led/m 60

STRIP

Rotolo 5 metri strip led.
Roll 5 meters strip-led.

EASY
DOMOTICA



Driver p. 837-846
Controller p. 848-851



Materiale
kapton senza silicone

Material
kapton without silicone

Temperatura colore
RGB



Driver
DC24V
tensione costante non incluso

Durata e on/off
50.000h
>25.000 on/off

Colour temperature
RGB



Driver
DC24V
constant voltage not included

Life time and on/off
50.000h
>25.000 on/off

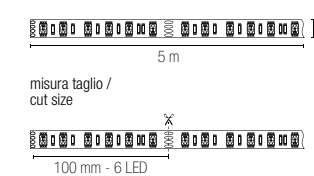
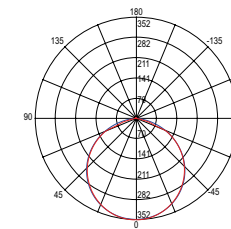

STRIP24V-5050-RGB

8031414871360
light source SMD 5050
watt/m 14,4W
led/m 60

colour temp.
RGB

Rotolo 15 metri strip led.
Roll 15 meters strip-led.

EASY
DOMOTICA



Driver p. 837-846
Controller p. 848-851



Materiale
kapton senza silicone

Material
kapton without silicone

Temperatura colore
RGB



Driver
DC24V
tensione costante non incluso

Durata e on/off
25.000h
>15.000 on/off

Colour temperature
RGB



Driver
DC24V
constant voltage not included

Life time and on/off
25.000h
>15.000 on/off

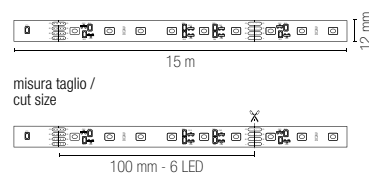
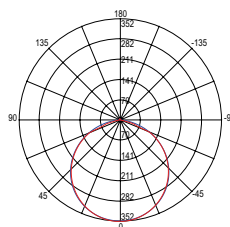

STRIPLED-CC15-RGB

8031414864560
light source SMD 5050
watt/m 10W
led/m 60

colour temp.
RGB

Rotolo 5 metri strip led.
Roll 5 meters strip-led.

EASY
DOMOTICA



Driver p. 837-846
Controller p. 848-851



Materiale
kapton con rivestimento in silicone

Material
kapton with silicone cover

Temperatura colore
RGB



Driver
DC24V
tensione costante non incluso

Durata e on/off
50.000h
>25.000 on/off

Colour temperature
RGB



Driver
DC24V
constant voltage not included

Life time and on/off
50.000h
>25.000 on/off

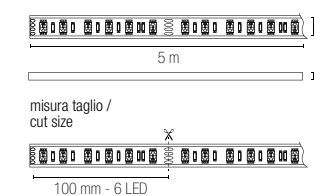
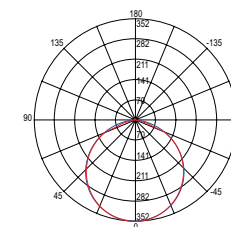

STRIP24V-5050RGB-IP67

8031414871377
light source SMD 5050
watt/m 14,4W
led/m 60

colour temp.
RGB

STRIP

Rotolo 5 metri strip led.
Roll 5 meters strip-led.

EASY
DOMOTICA



Driver p. 837-846
Controller p. 848-851



Materiale
kapton
senza silicone

Temperatura colore
RGB + 4000K



Driver
DC24V
tensione costante
non incluso

Durata e on/off
50.000h
>25.000 on/off

Material
kapton
without silicone

Colour temperature
RGB + 4000K



Driver
DC24V
constant voltage
not included

Life time and on/off
50.000h
>25.000 on/off

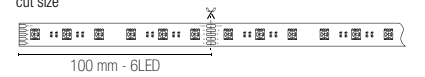
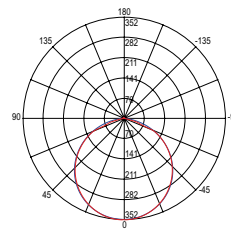

STRIP24V-5050-RGBW

8031414871384

lumen/m

total lumen

light source

watt/m

led/m

colour
temp.



RGB + 1080 lm

5400 lm

SMD 5050

19,2W

60

STRIP

Rotolo 5 metri strip led.
Roll 5 meters strip-led.

EASY
DOMOTICA



Driver p. 837-846
Controller p. 848-851



Materiale
kapton
senza silicone

Temperatura colore
RGB



Driver
DC24V
tensione costante
non incluso

Durata e on/off
50.000h
>25.000 on/off

Material
kapton
without silicone

Colour temperature
RGB



Driver
DC24V
constant voltage
not included

Life time and on/off
50.000h
>25.000 on/off

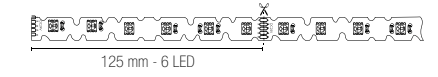
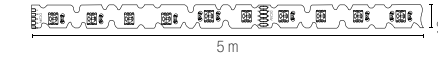
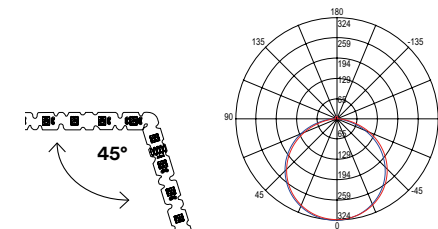

STRIP24V-5050-3D-RGBW

8031414878819

lumen/m

light source

watt/m

led/m

colour
temp.



RGB + 264 lm

SMD 5050

10W

48

Rotolo 5 metri strip led.
Roll 5 meters strip-led.

EASY
DOMOTICA



Driver p. 837-846
Controller p. 848-851

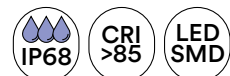

Materiale
kapton con
rivestimento
in silicone

Temperatura colore
RGB + 4000K



Driver
DC24V
tensione costante
non incluso

Durata e on/off
50.000h
>25.000 on/off

Material
kapton
with silicone
cover

Colour temperature
RGB + 4000K



Driver
DC24V
constant voltage
not included

Life time and on/off
50.000h
>25.000 on/off

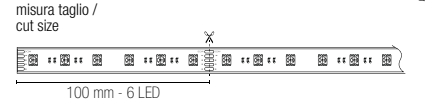
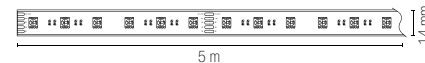
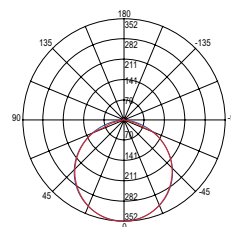

STRIP24V-5050RGBW-IP68

8031414871407

lumen/m

total lumen

light source

watt/m

led/m

colour
temp.



RGB + 1080 lm

5400 lm

SMD 5050

19,2W

60



STRIP

Rotolo 5 metri strip led.
Roll 5 meters strip-led.



EASY
DOMOTICA



Driver p. 837-846
Controller p. 848-851



Materiale

kapton
con silicone

Temperatura colore

RGB + CCT



Driver

DC24V

tensione costante
non incluso

Durata e on/off

50.000h
>25.000 on/off

Material

kapton
with silicone

Colour temperature

RGB + CCT



Driver

DC24V

constant voltage
not included

Life time and on/off

50.000h
>25.000 on/off

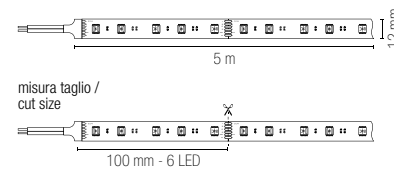
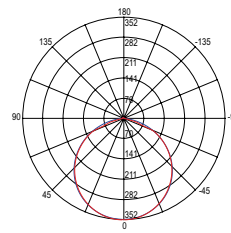

STRIP24V-5050-RGBCCT

8031414871391

lumen/m
total lumen

SMD 5050

watt/m 19,2W

led/m 60

colour
temp.



+

712 lm
3560 lm

Rotolo 5 metri strip led.
Roll 5 meters strip-led.



EASY
DOMOTICA



Driver p. 837-846
Controller p. 848-851



Materiale

kapton
senza silicone

Temperatura colore

RGB



Driver

DC24V

tensione costante
non incluso

Durata e on/off

50.000h
>25.000 on/off

Material

kapton
without silicone

Colour temperature

RGB



Driver

DC24V

constant voltage
not included

Life time and on/off

50.000h
>25.000 on/off

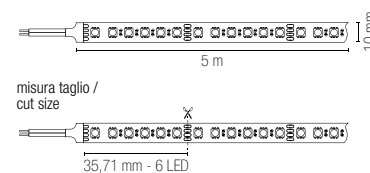
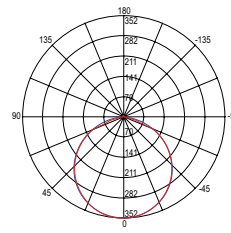

STRIP24V-3838-168RGB

8031414877898

light source

SMD 3838

watt/m

24W

led/m

168

colour
temp.



RGB



STRIP

Kit strip LED Wi-Fi.
Kit strip LED Wi-Fi.



WI-FI
SMART INTEC



Driver p. 837-846
Controller p. 848-851



Materiale
kapton
senza silicone

Temperatura colore
RGB + 4000K

Driver
12V DC
incluso

Durata e on/off
25.000h
>12.500 on/off

Material
kapton
without silicone

Colour temperature
RGB + 4000K

Driver
12V DC
included

Life time and on/off
25.000h
>12.500 on/off

STRIP24V-5050RGBW-INT
8031414881796

lumen/m 280 lm
total lumen 540 lm

light source SMD 5050
watt/m 6,5W
led/m 60

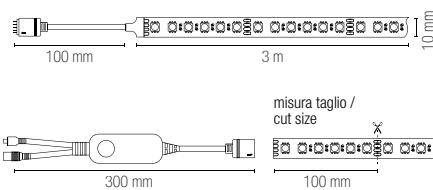

Accessori inclusi / Included accessories

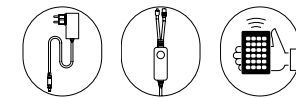

Driver + Telecomando + accessori Wi-Fi /
Diver + Remote control + Wi-Fi accesories

Control system easy installation



STRIP

Kit strip LED Wi-Fi.
Kit strip LED Wi-Fi.



WI-FI
SMART INTEC



Driver p. 837-846
Controller p. 848-851



Materiale
kapton
senza silicone

Temperatura colore
3000K / 4000K

Driver
12V DC
incluso

Durata e on/off
25.000h
>12.500 on/off

Material
kapton
without silicone

Colour temperature
3000K / 4000K

Driver
12V DC
included

Life time and on/off
25.000h
>12.500 on/off

STRIP24V-2835C-INT
8031414882182

lumen/m 380 lm
total lumen 760 lm

STRIP24V-2835M-INT
8031414881789

lumen/m 380 lm
total lumen 760 lm

light source SMD 2835
watt/m 6,5W
led/m 60

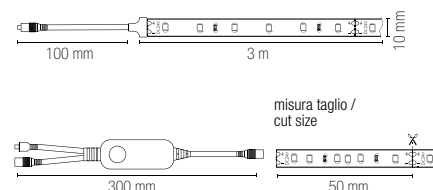

Accessori inclusi / Included accessories

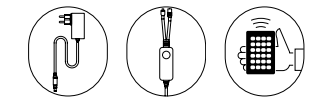

Driver + Telecomando + accessori Wi-Fi /
Diver + Remote control + Wi-Fi accesories

Control system easy installation





STRIP

**Rotolo strip led 3 metri
incluso di alimentatore.**
Kit 3 meters roll strip led
with driver included.



CE, EMC, RoHS
Driver p. 837-846
Controller p. 848-851

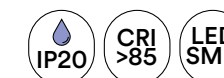

Materiale	Material
kapton senza silicone	kapton without silicone
Temperatura colore 3000K / 4000K / 6000K	Colour temperature 3000K / 4000K / 6000K
Driver 36W - 24V DC incluso	Driver 36W - 24V DC included
Durata e on/off 25.000h >12.500 on/off	Life time and on/off 25.000h >12.500 on/off

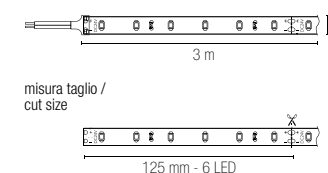
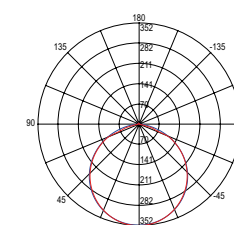

	colour temp.
STRIP24V-2835C-KIT 8031414871414	820 lm/m
STRIP24V-2835M-KIT 8031414871421	820 lm/m
STRIP24V-2835F-KIT 8031414871438	820 lm/m
light source	SMD 2835
watt/m	10W
led/m	48

Accessori inclusi / Included accessories
36W - 24V DC

**Rotolo strip led 3 metri
incluso di alimentatore.**
Kit 3 meters roll strip led
with driver included.



EASY
DOMOTICA



CE, EMC, RoHS
Driver p. 837-846
Controller p. 848-851



Materiale	Material
kapton senza silicone	kapton without silicone
Temperatura colore RGB	Colour temperature RGB
Driver 24W - 24V DC incluso	Driver 24W - 24V DC included
Durata e on/off 25.000h >12.500 on/off	Life time and on/off 25.000h >12.500 on/off

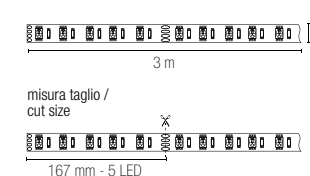
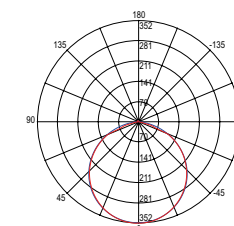

	colour temp.
STRIP24V-5050RGB-KIT 8031414871445	RGB
light source	SMD 5050
total power 3m	21,6W
total led 3m	90

Accessori inclusi / Included accessories



24W - 24V DC + Telecomando + Controller RGB /
24W - 24V DC + Remote control + Controller RGB



Rotolo 20 metri striscia led ultraflessibile in silicone.
20 meters roll extra flexible led line in silicone.

EASY DOMOTICA



Driver p. 837-846
Controller p. 848-851

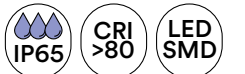

Materiale
silicone

Temperatura colore
5000K
GIALLO/ROSSO/VERDE



Driver
DC24V (8,3A)
tensione costante
non incluso

Durata e on/off
25.000h
>15.000 on/off

Material
silicone

Colour temperature
5000K
YELLOW/RED/GREEN



Driver
DC24V (8,3A)
constant voltage
not included

Durata e on/off
25.000h
>15.000 on/off

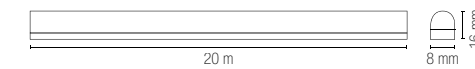
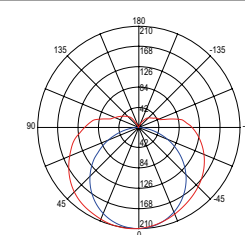

	colour temp.
NEON-FLEX-BIANCO 8031440361842 lumen	344 lm/m
NEON-FLEX-GIALLO 8031440364515 lumen	yellow
NEON-FLEX-ROSSO 8031440364560 lumen	red
NEON-FLEX-VERDE 8031440364546 lumen	green

light source	SMD 2835
watt/m	8W
led/m	140

Accessori non inclusi /
Not included accessories



NEON-FLEX-CAP 8031440364522 Kit 4 tappi in silicone	Kit 4 pcs silicon caps
---	---------------------------



NEON-FLEX-NEX 8031440364478 Connettore di giunzione entrata e uscita 15 cm	Linkable connector input and output 15 cm
---	---



NEON-FLEX-NEX-T 8031440364485 Connettore T a 3 entrate 30 x 15 cm	T connector with 3 input 30 x 15 cm
--	---



NEON-FLEX-POWER 8031440364508 Innesto elettrico 15 cm	Electrical connector 15 cm
---	-------------------------------



NEON-FLEX-STAFFE 8031440364492 Kit 2 pz staffe in metallo 10 x 1,3 x 1 cm	Kit 2 pcs metal 10 x 1,3 x 1 cm
--	------------------------------------

INSIGN

Kit 20 pz moduli LED.
Kit 20 pcs LED module.



kit 20pz con cavo 10cm / kit 20pcs with cable 10cm

EASY DOMOTICA



Driver p. 837-846
Controller p. 848-851



Materiale
PC

Temperatura colore
6000K



Driver
DC12V

tensione costante
non incluso

Durata e on/off
50.000h
>25.000 on/off

Material
PC

Colour temperature
6000K



Driver
DC12V

constant voltage
not included

Life time and on/off
50.000h
>25.000 on/off

LED-INSIGN-F-LENS
8031414871155
lumen

colour temp.
120 lm/m

sorgente luminosa / light source LED SMD 5050
watt/m 20 x 1,2W
beam angle 160°

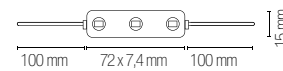

Kit 20 pz moduli LED.
Kit 20 pcs LED module.



kit 20pz con cavo 10cm / kit 20pcs with cable 10cm

EASY DOMOTICA



Driver p. 837-846
Controller p. 848-851

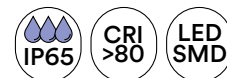

Materiale
PC

Temperatura colore
RGB + 6000K



Driver
DC12V

tensione costante
non incluso

Durata e on/off
50.000h
>25.000 on/off

Material
PC

Colour temperature
RGB + 6000K



Driver
DC12V

constant voltage
not included

Life time and on/off
50.000h
>25.000 on/off

LED-INSIGN-F
8031414862979
lumen

colour temp.
72 lm/m

LED-INSIGN-RGBW
8031414862955
lumen

colour temp.
RGB + 72 lm/m

light source SMD 5050
watt/m 20 x 0,72W
beam angle 120°

light source SMD 5050
watt/m 20 x 0,96W
beam angle 120°

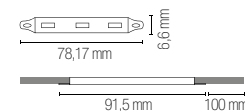
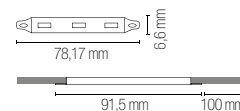

STRIP

Strip LED comando touch con attacco USB.
LED strip light with switch touch control and USB connection.



Materiale
kapton con
rivestimento in silicone

Temperatura colore
RGB



Material
kapton with
silicone cover

Colour temperature
RGB

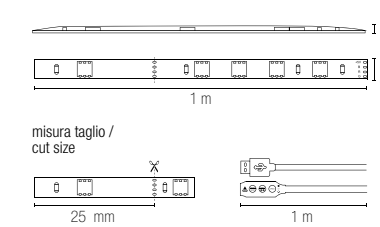

STRIP-SURROUND
8031440354202

colour temp.
RGB

light source SMD 5050
watt/m 1,5W
led/m 15

Kit strip con telecomando e funzione RGB music color con attacco USB.
Kit strip with remote control and RGB music function with USB connection.

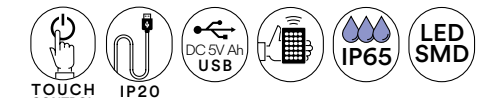

Materiale
kapton con
rivestimento in silicone

Temperatura colore
RGB



Material
kapton with
silicone cover

Colour temperature
RGB

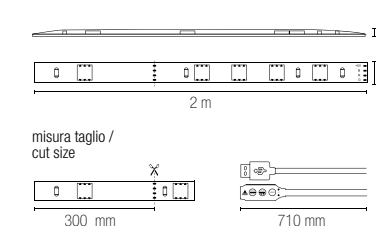

STRIP-SURROUND-2M
8031414881802

colour temp.
RGB

light source SMD 5050
watt/m 3W
led/m 60

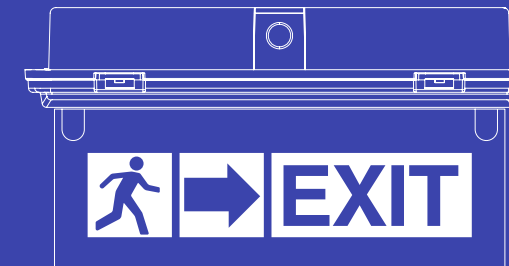

LAMPADE D'EMERGENZA

EMERGENCY LAMPS

ETERNA

Plafoniera LED in policarbonato bianca con batteria Ni-Cd con durata fino a 12H e funzione d'emergenza combinata e permanente.
White polycarbonate LED ceiling light with Ni-Cd battery with 12H dino duration and emergency function mantain or non-mantain.

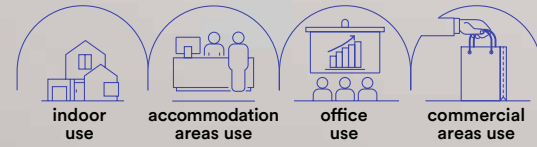

technical information **ETERNA**



- Materiale**
PC
- Colore**
bianco
- Temperatura colore**
4000K
- Material**
PC
- Colour**
white
- Colour temperature**
4000K



	colour temp.	colour
LED-ETERNA-54 8031440358521	●	●
lumen	900 lm	
emergency light	3 h - 120 lm	
watt	16W	
beam angle	120°	

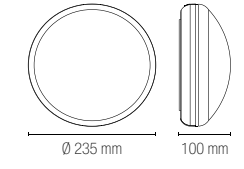

Ni-Cd 6V 1800 mAh
Batteria per emergenza inclusa /
Included emergency battery

	colour temp.	colour
LED-ETERNA-120 8031440358538	●	●
lumen	1160 lm	
emergency light	3 h - 120 lm	
watt	20W	
beam angle	120°	

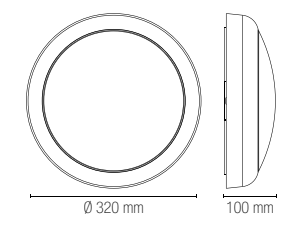

LiFePO4 3.2V 3200mAh
Batteria per emergenza inclusa /
Included emergency battery

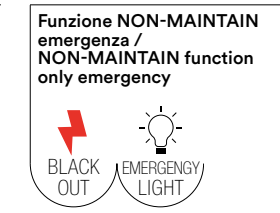
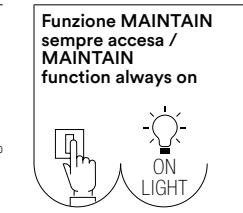
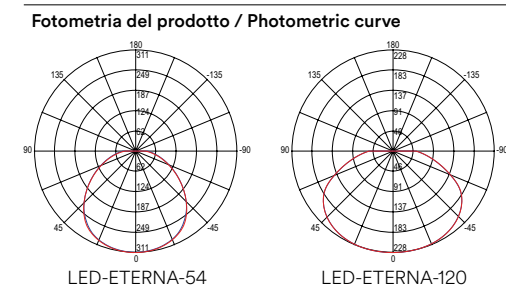

HELP INC

Incasso a LED emergenza in policarbonato bianco.
Emergency LED installation in white polycarbonate.

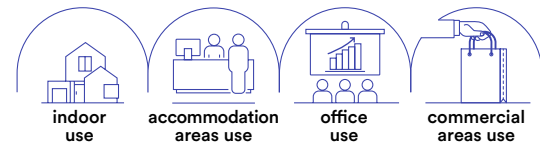

- Materiale**
policarbonato
- Colore**
bianco
- Temperatura colore**
4000K
- Driver**
incluso
- Material**
polycarbonate
- Colour**
white
- Colour temperature**
4000K
- Driver**
included

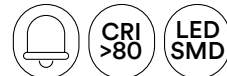

**Angolo di luce per open space /
Open space beam angle**

	colour temp.	colour
INC-HELP-R37 8031414882786		
lumen	130 lm	

watt	1,2W
beam angle	140°
	Ø 32 mm



**Angolo di luce direzionale asimmetrico /
Asymmetric directional beam angle**

	colour temp.	colour
INC-HELP-R37-NR 8031414883097		
lumen	130 lm	

watt	1,2W
beam angle	120° x 60°
	Ø 32 mm



LiFePO4 3.2V 1000mAh
Batteria per emergenza inclusa /
Included emergency battery



LiFePO4 3.2V 1000mAh
Batteria per emergenza inclusa /
Included emergency battery



Fotometria del prodotto / Photometric curve

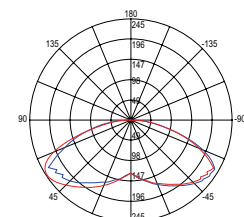

INC-HELP-R37

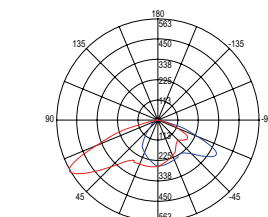

INC-HELP-R37-NR

HELP TRACK

Lampade di emergenza LED per sistema binario trifase nei colori bianco o nero.
LED emergency lamps for three-phase rail system in white or black.

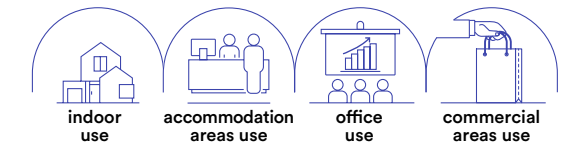

- Materiale**
policarbonato
- Colore**
bianco
nero
- Temperatura colore**
4000K
- Driver**
incluso
- Material**
polycarbonate
- Colour**
white
black
- Colour temperature**
4000K
- Driver**
included



	colour temp.	colour
LED-HELP-W-TRACK 8031414884179		
lumen	250 lm	
LED-HELP-B-TRACK 8031414884162		
lumen	250 lm	



watt	2W
beam angle	140°

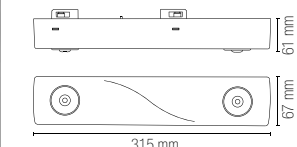

LiFePO4 3.2V 3200mAh
Batteria per emergenza inclusa /
Included emergency battery



LAMPADE D'EMERGENZA / EMERGENCY LAMPS

In.tec light

HELP EXIT

Lampada a LED di emergenza multiuso:
plafoniera, incasso ed incasso più bandiera.

Multipurpose emergency LED lamp:
ceiling lamps, recessed light and recessed with flag.

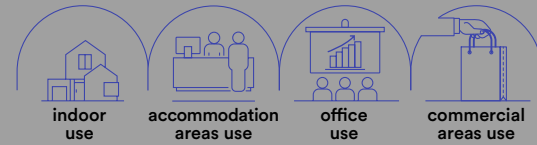

- Materiale**
PC
- Colore**
bianco
- Temperatura colore**
4000K
- Driver**
integrato
- Material**
PC
- Colour**
white
- Colour temperature**
4000K
- Driver**
built-in



LED-HELP-EXIT
8031414876310
lumen

colour temp.	colour
●	●
400 lm	

emergency light	3 h - 400 lm
watt	4W

2 x 7.4V 1.8Ah Li-ion
Batteria per emergenza inclusa /
Included emergency battery



Incluso adesivi /
With stickers kit

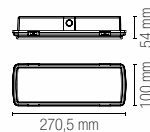

Accessori / Accessories



HELP-EXIT-KIT
8031414876327
Kit incasso cornice e molle /
Kit recessed with frame and spring

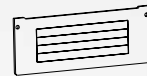

HELP-EXIT-FLAG
8031414877331
Kit bandiera incluso adesivi /
Emergency flag with stickers kit



Funzione MAINTAIN
sempre accesa /
MAINTAIN
function always on

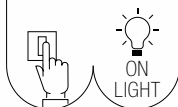

Funzione NON-MAINTAIN
emergenza /
NON-MAINTAIN function
only emergency

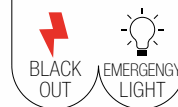

BOLT HELP



- Materiale**
polycarbonato
+ acciaio
- Colore**
bianco
nikel
- Temperatura colore**
4000K
- Driver**
integrato
- Material**
polycarbonate
+ stainless steel
- Colour**
white
nikel
- Colour temperature**
4000K
- Driver**
built-in

**Incasso segnapassi in policarbonato
con alloggiamento in cassetta di
derivazione 503 con placchetta
intercambiabile bianco o nikel in
alluminio per funzione di emergenza
combinata e permanente.**

Downlight in polycarbonate for
recessed box 503 built-in-LED with
replaceable in aluminum buckle white
or nikel finish and double emergency
function mantain or non-mantain.



	colour temp.	colour
INC-BOLT-503HP 8031414866243 lumen	●	●
	200 lm	

emergency light	3 h - 150 lm
watt	3W
	Ø 32 mm

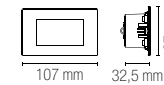

Accessori inclusi / Included accessories

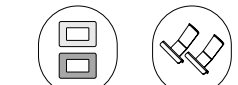

2x
placchette /
frames

2x
staffette /
brackets

scatola derivazione 503
503 junction box
non inclusa / not included

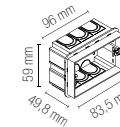

Li-ion 3,7V 700 mAh
Batteria per emergenza inclusa /
Included emergency battery



Funzione MAINTAIN
sempre accesa /
MAINTAIN
function always on

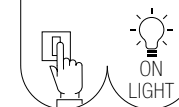

Funzione NON-MAINTAIN
emergenza /
NON-MAINTAIN function
only emergency

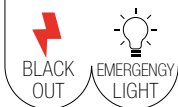

HELP 503

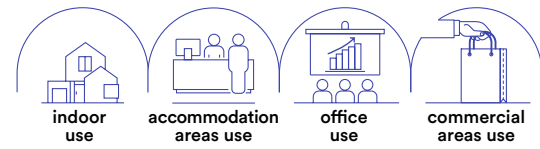

- Materiale**
polycarbonato
- Colore**
bianco
- Temperatura colore**
4000K
- Driver**
integrato
- Material**
polycarbonate
- Colour**
white
- Colour temperature**
4000K
- Driver**
built-in

Lampada di emergenza LED in polycarbonato con batteria Li-on incasso con cassetta di derivazione 503.
Emergency LED lamp in PC with Li-on battery; fit with recess box 503.



LED-HELP-503 8031414862573	colour temp.	colour
lumen	80 lm	
emergency light	3 h - 80 lm	
watt	1W	
beam angle	120°	
	90 × 55 × 31 mm	

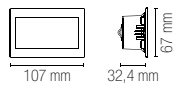

scatola derivazione 503
503 junction box
non inclusa / not included

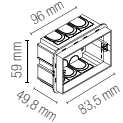

Li-ion 3,7V 700 mAh
Batteria per emergenza inclusa /
Included emergency battery



Funzione MAINTAIN
sempre accesa /
MAINTAIN
function always on

Funzione NON-MAINTAIN
emergenza /
NON-MAINTAIN function
only emergency

HELP 511

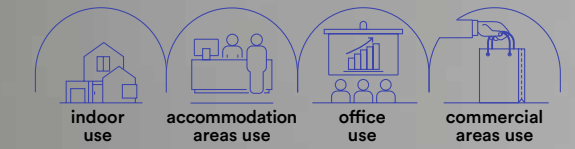

- Materiale**
polycarbonato
- Colore**
bianco
- Temperatura colore**
4000K
- Driver**
integrato
- Material**
polycarbonate
- Colour**
white
- Colour temperature**
4000K
- Driver**
built-in

Lampada di emergenza LED in polycarbonato con batteria Li-on incasso con cassetta di derivazione 511.
Emergency LED lamp in PC with Li-on battery; fit with recess box 511.

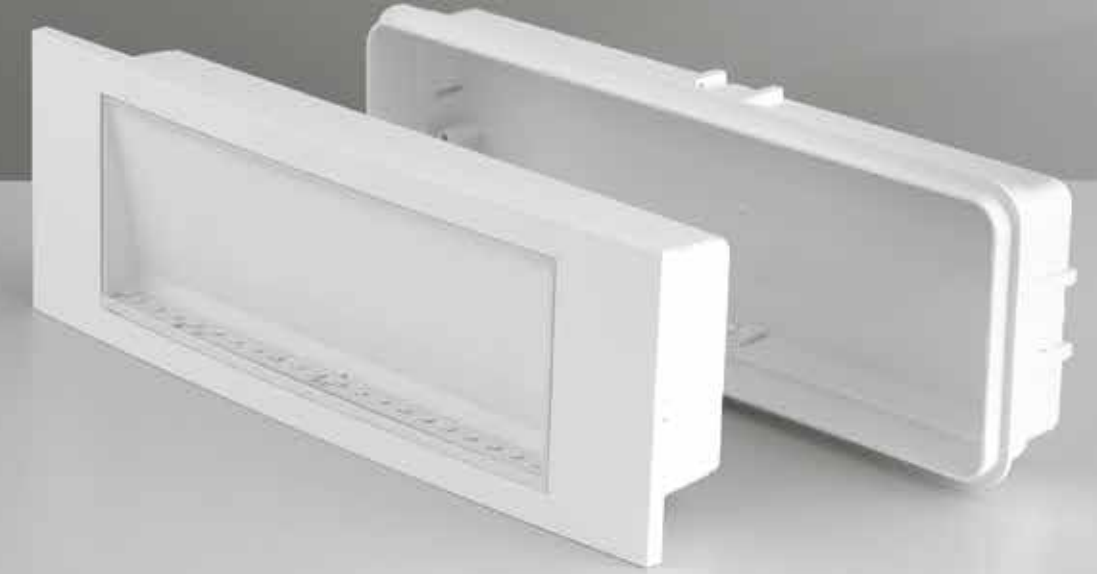

LED-HELP-511 8031414862566	colour temp.	colour
lumen	80 lm	
emergency light	3 h - 180 lm	
watt	4W	
beam angle	100°	
	275 × 95 × 35 mm	

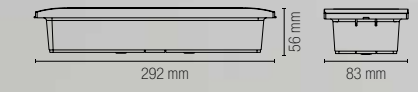

Accessori inclusi / Included accessories

Scatola derivazione /
Recess box hole



Adesivo /
Stickers



Li-ion 7.4V 1200mAh
Batteria per emergenza inclusa /
Included emergency battery



Funzione MAINTAIN
sempre accesa /
MAINTAIN
function always on

Funzione NON-MAINTAIN
emergenza /
NON-MAINTAIN function
only emergency

LAMPADE D'EMERGENZA / EMERGENCY LAMPS

In.tec light

OUTDOOR

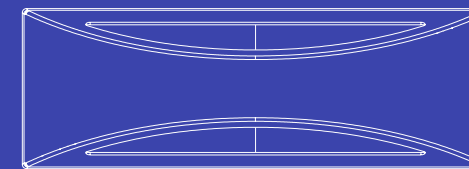

APPLIQUE

WALL LAMPS

COMPASS

Applique a LED in alluminio orientabile colore antracite.
Adjustable LED wall lamp in aluminum anthracite colour.



- Materiale**
alluminio
- Colore**
antracite
- Temperatura colore**
CCT
- Driver**
incluso
- Material**
aluminum
- Colour**
anthracite
- Colour temperature**
CCT
- Driver**
included

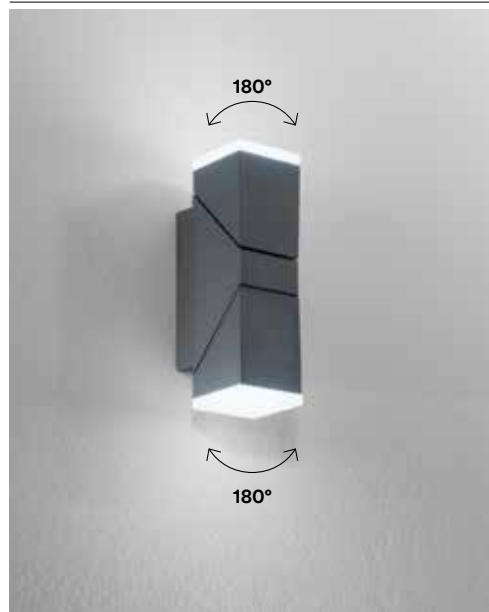

LED-W-COMPASS-INT
8031414870158

	colour temp.	colour
lumen	470 lm	
watt		10W
beam angle	↓ 110° + 110° ↑	



65 mm
220 mm

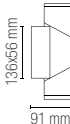

136x56 mm
91 mm

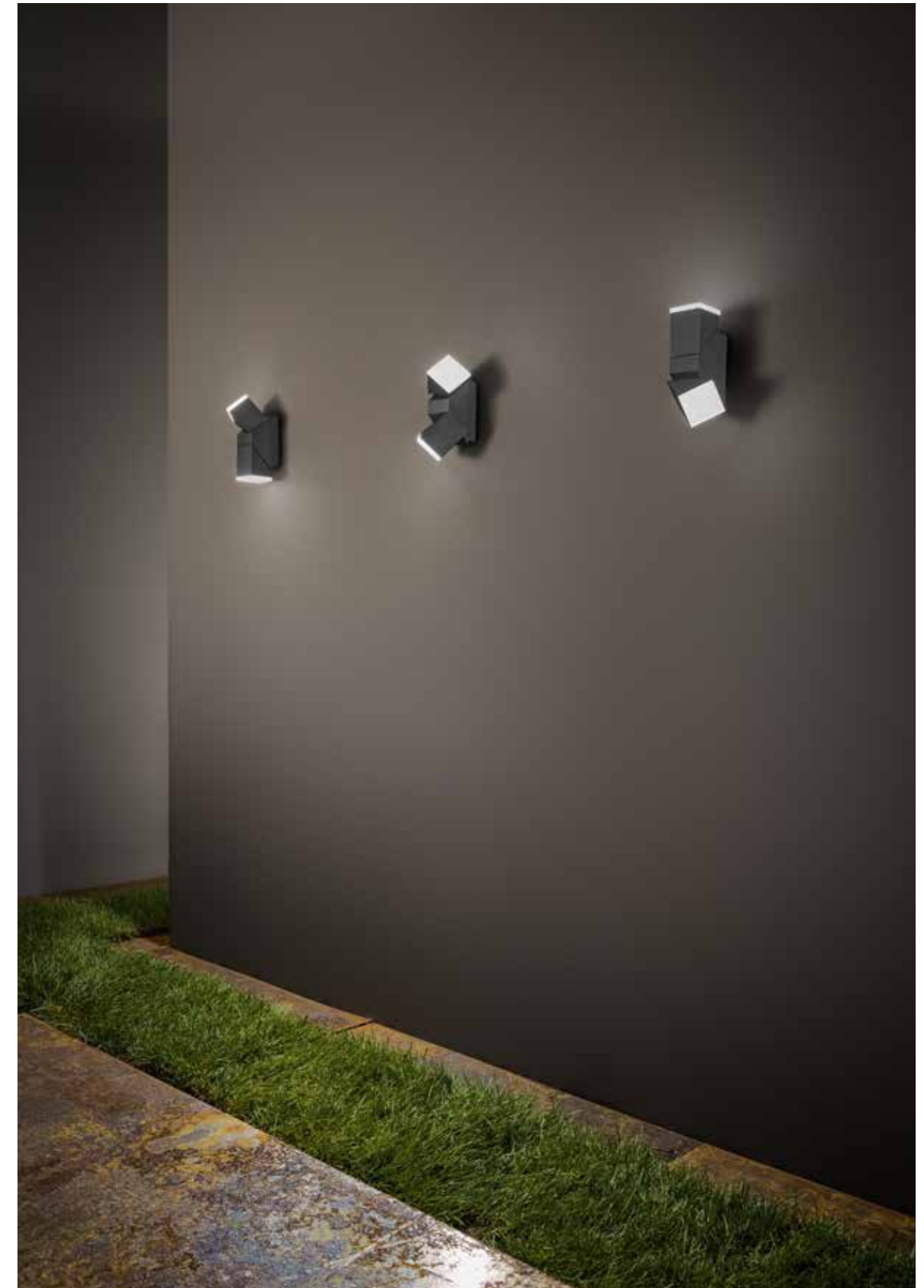

Control system easy installation

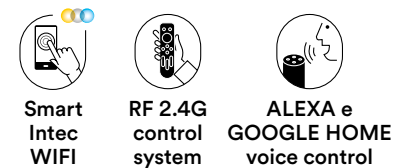

COMPACT

Applique a LED in alluminio colore antracite con diffusore in policarbonato.
Anthracite aluminum LED wall lamp and PC diffuser.

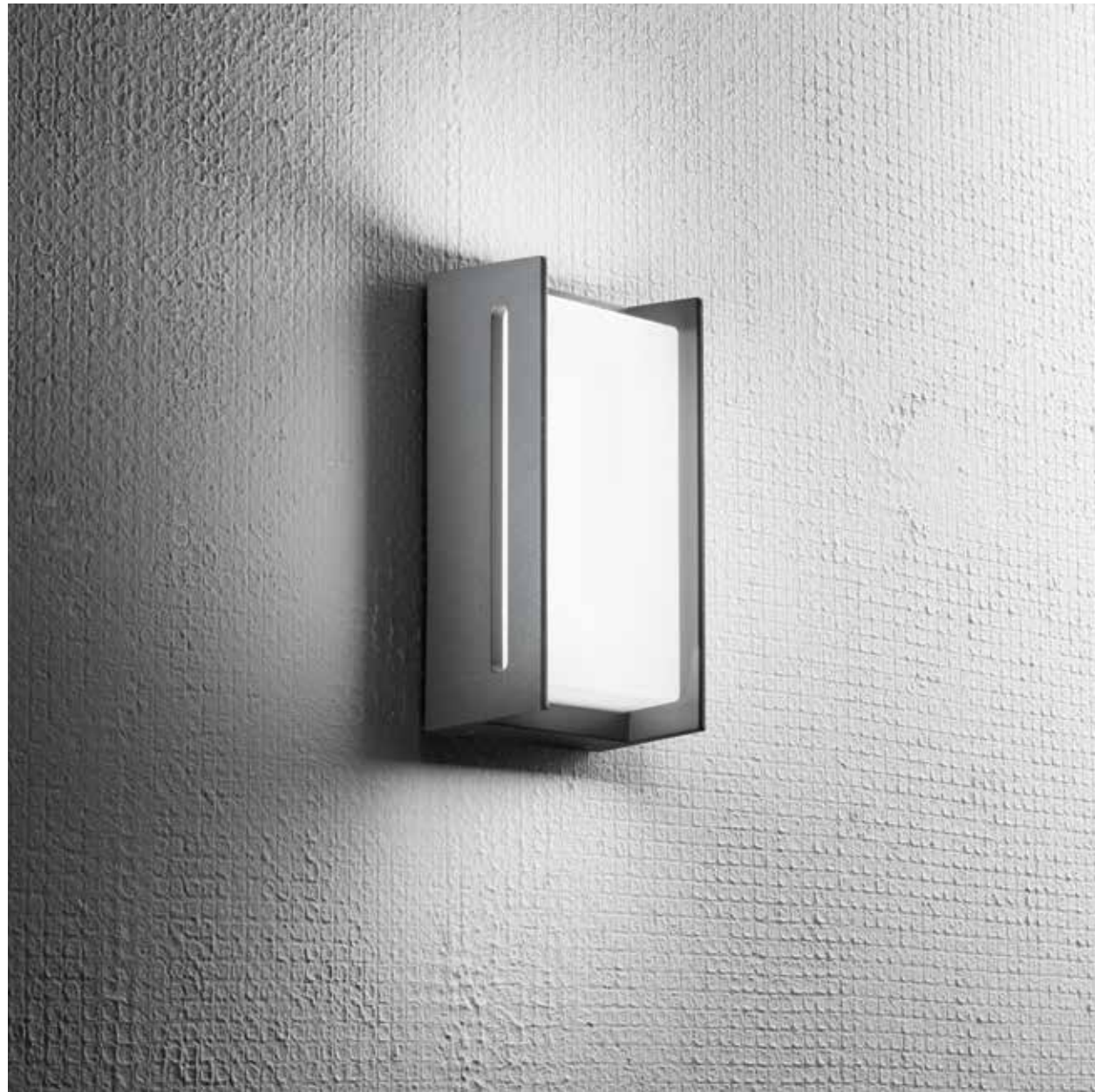

Materiale
alluminio +
policarbonato

Colore
antracite

**Temperatura colore
selezionabile**
3000K / 4000K



Driver
incluso

Material
aluminum +
polycarbonate

Colour
anthracite

**Selectable color
temperature**
3000K / 4000K



Driver
included



LED-W-COMPACT

8031414867110

lumen

colour temp.



2260 lm

colour



watt 18W
beam angle 120°

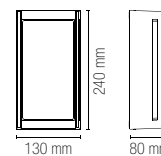

DETROIT

Applique a LED in alluminio nero diffusore in policarbonato.
Aluminum LED wall lamp black finish with PC shade.



Materiale
alluminio +
policarbonato

Colore
nero

Temperatura colore
4000K



Driver
incluso

Material
aluminum +
polycarbonate

Colour
black

Colour temperature
4000K



Driver
included



LED-W-DETROIT-AP

8031414862290

lumen

colour temp.



700 lm

watt 10W
beam angle 120°

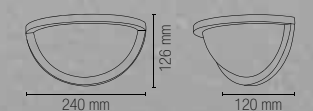

AMON

Applique a LED in alluminio gofrato bianco o nero.
Aluminum LED wall lamp embossed white or black finish.



technical information **AMON**

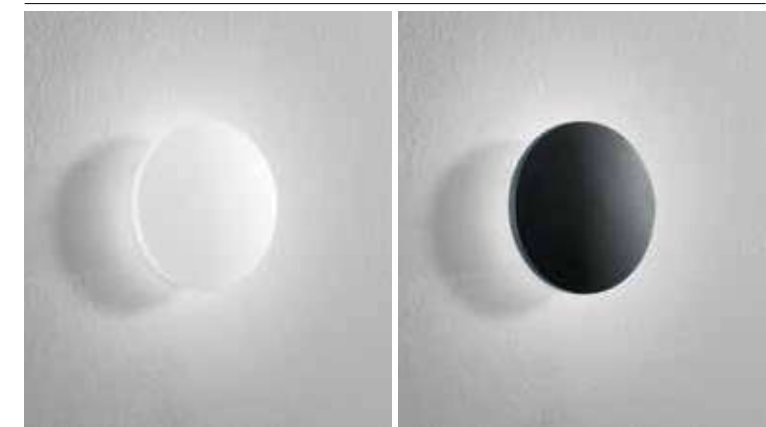

	colour temp.	colour
LED-W-AMON-SC BCO 8031414876723 lumen	620 lm	
LED-W-AMON-S BCO 8031414866946 lumen	620 lm	
LED-W-AMON-S NERO 8031414866939 lumen	620 lm	
watt	6W	
beam angle	360°	

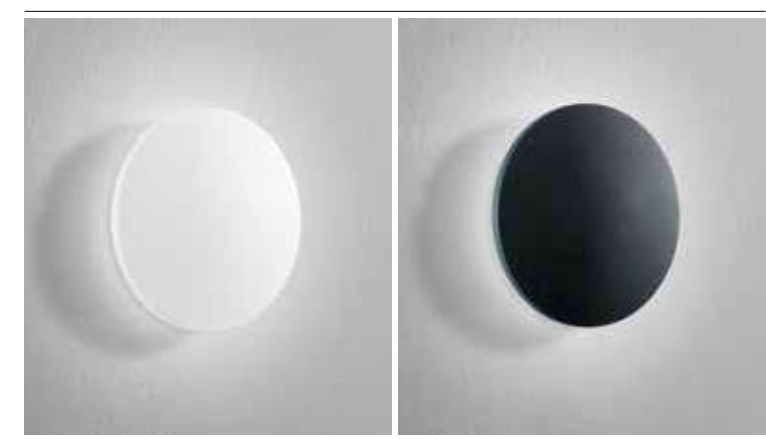
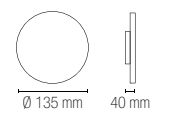

	colour temp.	colour
LED-W-AMON-MC BCO 8031414876709 lumen	660 lm	
LED-W-AMON-M BCO 8031414867165 lumen	660 lm	
LED-W-AMON-M NERO 8031414867158 lumen	660 lm	
watt	9W	
beam angle	360°	

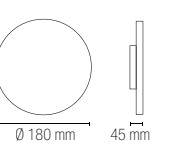

Materiale alluminio	Material aluminum
Colore gofrato bianco gofrato nero	Colour embossed white embossed black
Temperatura colore 3000K / 4000K	Colour temperature 3000K / 4000K
Driver incluso	Driver included

In.tec light **OUTDOOR** APPLIQUE / WALL LAMPS

ZODIAC

Applique a LED in policarbonato nei colori bianco e nero.
LED polycarbonate wall lamp in black and white.

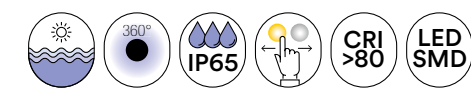
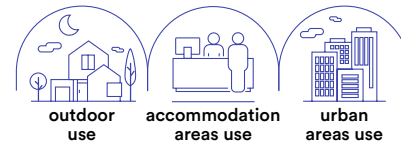

technical information **ZODIAC**



- Materiale**
PC
- Colore**
bianco
nero
- Temperatura colore selezionabile**
3000K / 4000K
- Driver**
integrato
- Material**
PC
- Colour**
white
black
- Selectable color temperature**
3000K / 4000K
- Driver**
built-in

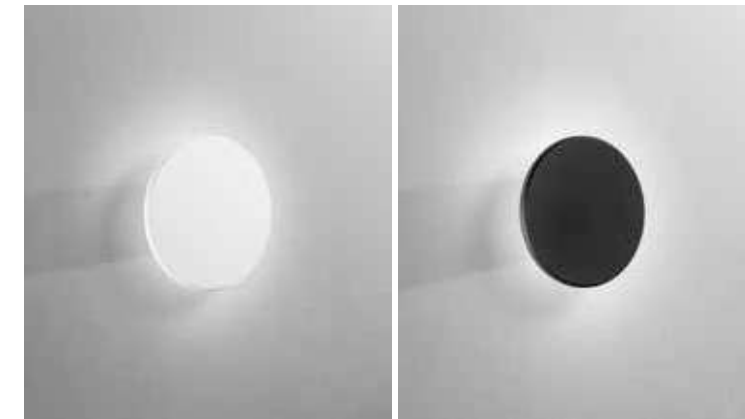

	colour temp.	colour	
LED-W-ZODIAC-M-BCO 8031414889846			
lumen	1200 lm		
LED-W-ZODIAC-M-NER 8031414889853			
lumen	1200 lm		
watt			12W
beam angle			360°

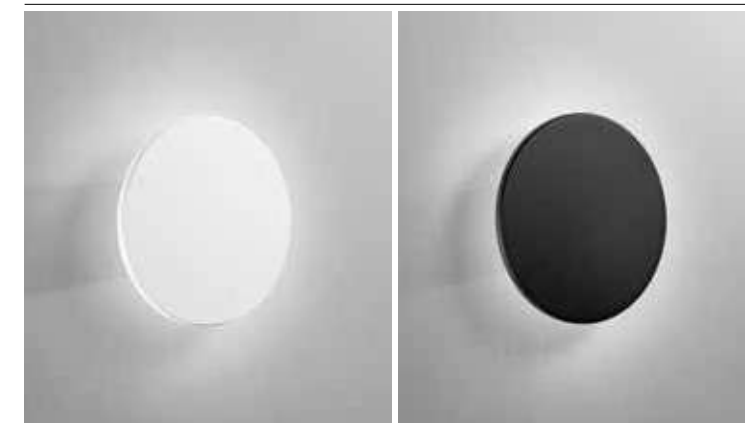

	colour temp.	colour	
LED-W-ZODIAC-L-BCO 8031414889860			
lumen	1800 lm		
LED-W-ZODIAC-L-NER 8031414889877			
lumen	1800 lm		
watt			18W
beam angle			360°

STEALTH

Applique a LED in alluminio gofrato bianco o nero.
Aluminum LED wall lamp embossed white or black.

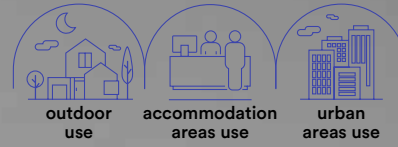

technical information **STEALTH**



Materiale
alluminio

Material
aluminum

Colore
gofrato bianco
gofrato nero

Colour
embossed white
embossed black



Temperatura colore
4000K

Colour temperature
4000K



Temperatura colore selezionabile
3000K / 4000K

Selectable color temperature
3000K / 4000K



Driver
incluso

Driver
included



LED-W-STEALTH BCO
8031414866960
lumen

colour temp.	colour
470 lm	

watt 7W
beam angle 120°

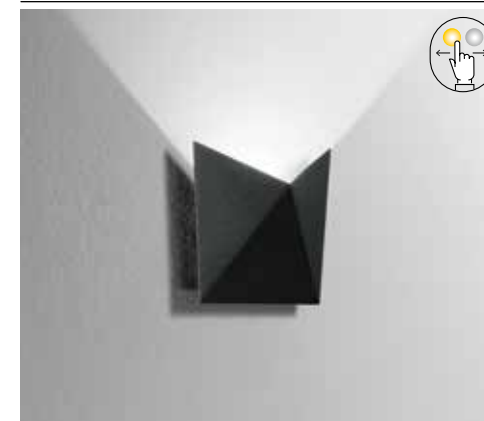
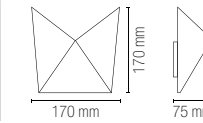

LED-W-STEALTH NER
8031414866953
lumen

colour temp.	colour
470 lm	

watt 7W
beam angle 120°

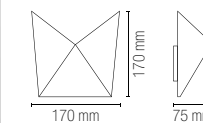

MERCURY

Applique a LED in alluminio gofrato bianco.
Aluminum LED wall lamp embossed white finish.

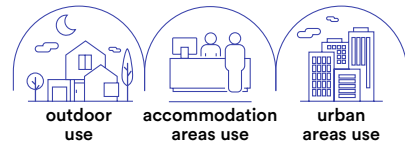

Materiale
alluminio

Material
aluminum

Colore
gofrato bianco

Colour
embossed white

Temperatura colore
3000K

Colour temperature
3000K



Driver
incluso

Driver
included

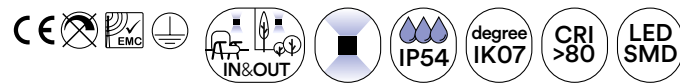

LED-W-MERCURY/5W

8031434091212

lumen

colour temp.	colour
630 lm	

watt	6W
beam angle	↓ 120° + 120° ↑

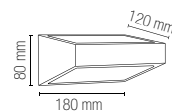

GAMMA

Applique a LED in alluminio gofrato bianco.
Aluminum LED wall lamp embossed white finish.



Materiale
alluminio

Material
aluminum

Colore
gofrato bianco

Colour
embossed white

Temperatura colore selezionabile
3000K / 4000K

Selectable color temperature
3000K / 4000K

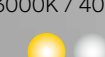

Driver
incluso

Driver
included



LED-W-GAMMA/10W

8031434041217

lumen

colour temp.	colour
1100 lm	

watt	2 x 5W
beam angle	↓ 120° + 120° ↑

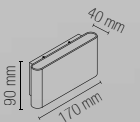

MIURA

Applique a LED in alluminio
bianco goffrato ultrasottile.
Ultra-thin embossed white
aluminum LED wall light.



outdoor use accommodation areas use urban areas use

TUNNEL

Applique a LED in alluminio
colore antracite diffusore
in policarbonato.
Aluminum LED
wall lamp anthracite
colour, shade in PC.



outdoor use accommodation areas use urban areas use



Materiale
alluminio

Material
aluminium

Colore
goffrato bianco

Colour
embossed white

**Temperatura colore
selezionabile**
3000K / 4000K

**Selectable color
temperature**
3000K / 4000K



Driver
incluso

Driver
included



LED-W-MIURA/6W

8031440351447

lumen

colour temp. colour



520 lm

watt

2 x 3W

beam angle

↓ 110° + 110° ↑



Materiale
alluminio
+ policarbonato

Material
aluminum
+ polycarbonate

Colore
antracite e
bianco latte

Colour
anthracite and
milky white

Temperatura colore

4000K

Colour temperature

4000K

Driver
incluso

Driver
included



LED-W-TUNNEL

8031414863556

lumen

colour temp. colour



800 lm

watt

12W

beam angle

120°

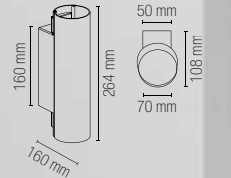

VEYRON

Applique a LED in alluminio con doppia emissione bianco o nero gofrato.
LED aluminum wall light with double emission in white or black.

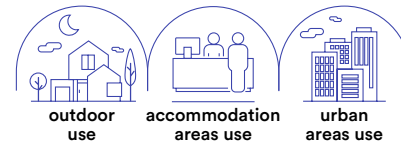

technical information **VEYRON**



- Materiale**
alluminio
- Colore**
gofrato bianco
gofrato nero
- Temperatura colore selezionabile**
3000K / 4000K
- Driver**
incluso
- Material**
aluminum
- Colour**
embossed white
embossed black
- Selectable color temperature**
3000K / 4000K
- Driver**
included



	colour temp.	colour
LED-W-VEYRON BCO 8031440361163		
lumen	840 lm	

watt	2 x 3,5W
beam angle	↓ 120° + 120° ↑

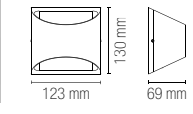

	colour temp.	colour
LED-W-VEYRON NERO 8031440361095		
lumen	840 lm	

watt	2 x 3,5W
beam angle	↓ 120° + 120° ↑

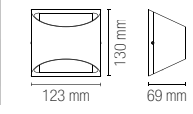

BIOME

Applique a LED in alluminio bianco o nero goffrato.
LED aluminum wall lamps in embossed white or black.

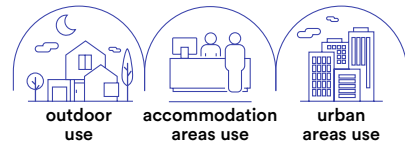

technical information **BIOME**



- Materiale**
alluminio
- Colore**
goffrato bianco
goffrato nero
- Temperatura colore**
4000K
- Driver**
incluso
- Material**
aluminum
- Colour**
embossed white
embossed black
- Colour temperature**
4000K
- Driver**
included



	colour temp.	colour
LED-W-BIOME BCO 8031440361125		
lumen	900 lm	
watt	2 x 3,5W	
beam angle	↓ 120° + 120° ↑	

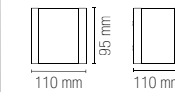

	colour temp.	colour
LED-W-BIOME NERO 8031440361132		
lumen	900 lm	
watt	2 x 3,5W	
beam angle	↓ 120° + 120° ↑	

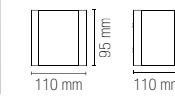

GOLF

Applique a LED in alluminio gofrato bianco o nero.
Aluminum LED wall lamp embossed white or black finish.



technical information **GOLF**



Materiale
alluminio

Colore
gofrato bianco
gofrato nero



Temperatura colore selezionabile
3000K / 4000K



Driver
incluso

Material
aluminum

Colour
embossed white
embossed black





Selectable color temperature
3000K / 4000K



Driver
included





LED-W-GOLF BCO
8031440361101

colour temp.	colour
 	
840 lm	

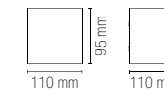
watt 2 x 3,5W
beam angle ↓ 120° + 120° ↑



LED-W-GOLF NERO
8031440361118

colour temp.	colour
 	
840 lm	

watt 2 x 3,5W
beam angle ↓ 120° + 120° ↑

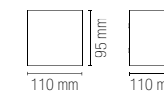

POLO

Applique a LED in policarbonato con singola o doppia emissione bianco o nero opaco.

Polycarbonate LED wall light with single or double emission in matt white or black.

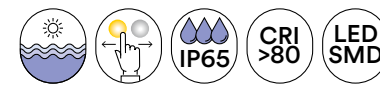
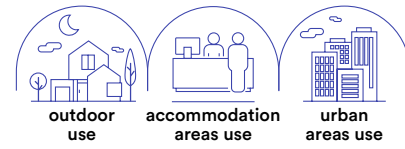

technical information **POLO**



Materiale
PC

Colore
bianco
nero



Temperatura colore selezionabile
3000K / 4000K



Driver
incluso

Material
PC

Colour
white
black



Selectable color temperature
3000K / 4000K



Driver
included

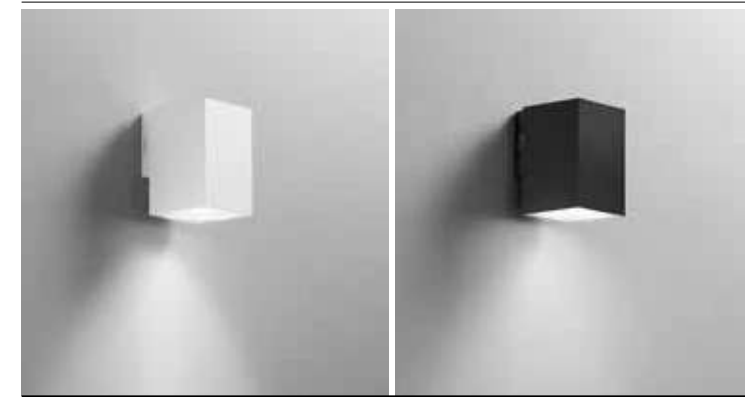

	colour temp.	colour
LED-W-POLO-Q1-BCO 8031414889655		
lumen	800 lm	
LED-W-POLO-Q1-NER 8031414889662		
lumen	800 lm	
watt	8W	
beam angle	60°	

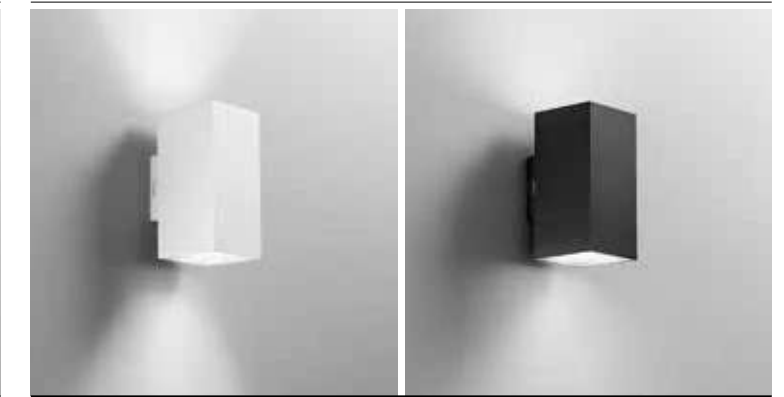

	colour temp.	colour
LED-W-POLO-Q2-BCO 8031414889679		
lumen	1600 lm	
LED-W-POLO-Q2-NER 8031414889686		
lumen	1600 lm	
watt	2 x 8W	
beam angle	↓ 60° + 60° ↑	

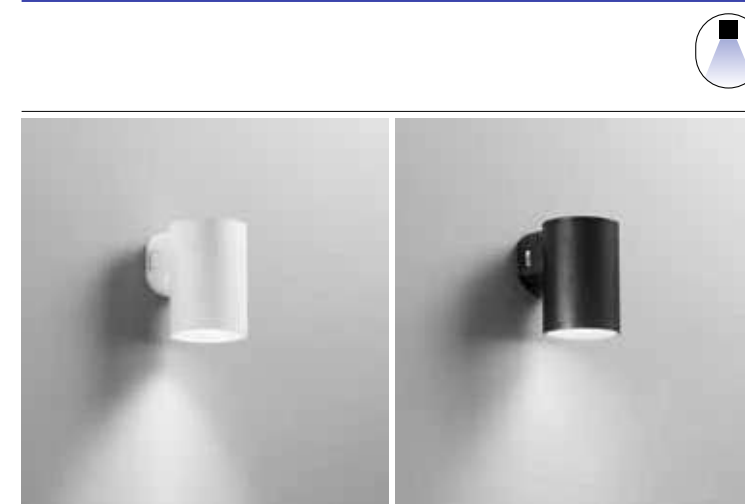
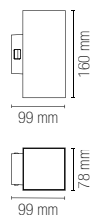

	colour temp.	colour
LED-W-POLO-R1-BCO 8031414889617		
lumen	800 lm	
LED-W-POLO-R1-NER 8031414889624		
lumen	800 lm	
watt	8W	
beam angle	60°	

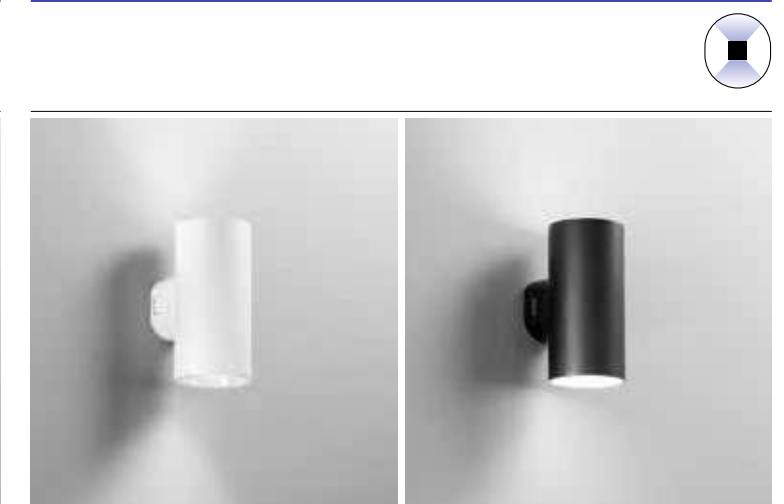

	colour temp.	colour
LED-W-POLO-R2-BCO 8031414889631		
lumen	1600 lm	
LED-W-POLO-R2-NER 8031414889648		
lumen	1600 lm	
watt	2 x 8W	
beam angle	↓ 60° + 60° ↑	

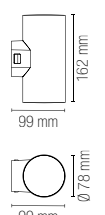

OUTDOOR APPLIQUE / WALL LAMPS

In.tec light

RAY

Applique a LED in alluminio biemissione più emissione frontale in antracite o corten gofrato.
 Aluminum LED wall lamp double emission light and front light stream embossed anthracite or corten finish.

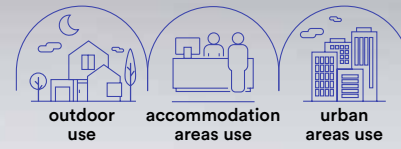

technical information **RAY**



- Materiale**
alluminio
- Colore**
gofrato antracite
gofrato corten
- Temperatura colore selezionabile**
3000K / 4000K
- Driver**
incluso
- Material**
aluminum
- Colour**
embossed anthracite
embossed corten
- Selectable color temperature**
3000K / 4000K
- Driver**
included



LED-W-RAY ANT
 8031414867127
 lumen 1100+390 lm

watt 14W
 beam angle ↓ 50° + 50° ↑ + 120° →

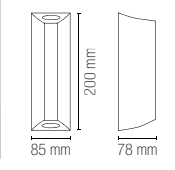

LED-W-RAY BRO
 8031414870998
 lumen 1100+390 lm

watt 14W
 beam angle ↓ 50° + 50° ↑ + 120° →

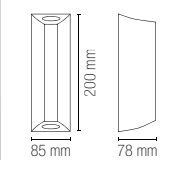

TWIN

Applique a LED in alluminio finitura bianco, antracite o nikel spazzolato.
Aluminum LED wall lamp in white, anthracite finish or brush nickel.

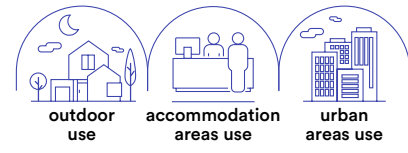

collection TWIN



Materiale
alluminio

Colore
bianco
antracite
nikel spazzolato

Temperatura colore
4000K

Temperatura colore selezionabile
3000K / 4000K

Driver
incluso

Material
aluminum

Colour
white
anthracite
brush nikel

Colour temperature
4000K

Selectable color temperature
3000K / 4000K

Driver
included

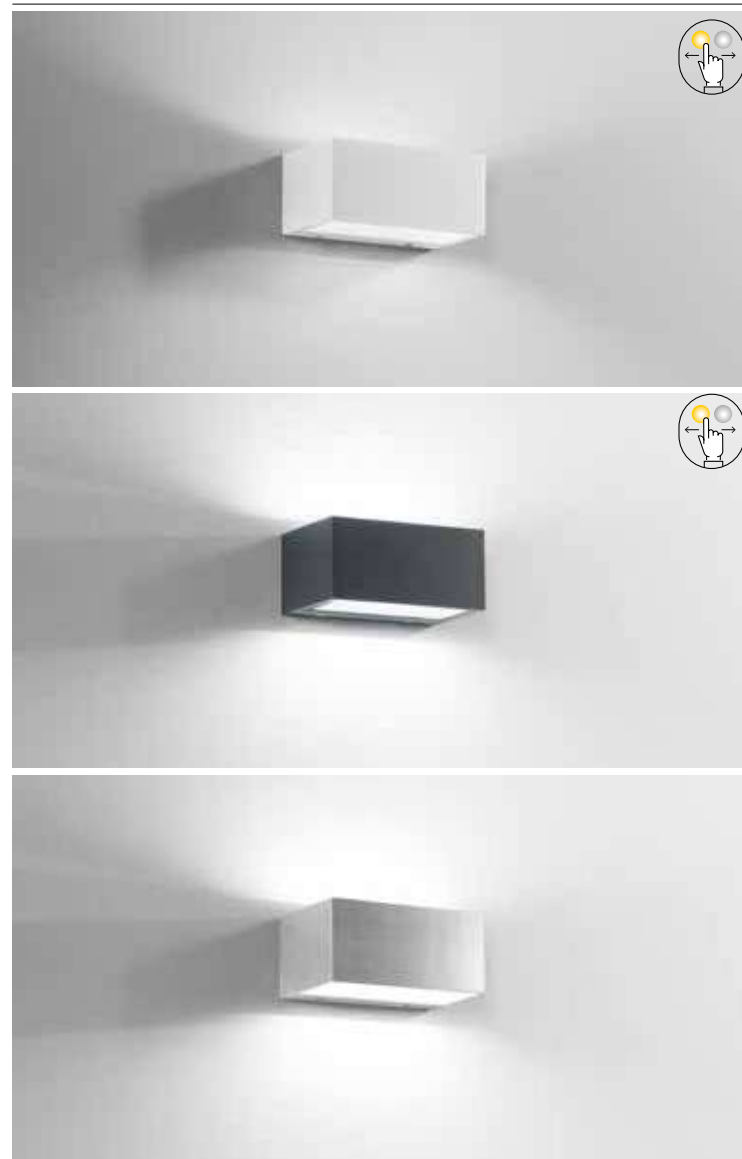

	colour temp.	colour
LED-W-TWIN-S BCO 8031414863976 lumen	1500 lm	
LED-W-TWIN-S ANT 8031414863709 lumen	1500 lm	
LED-W-TWIN-S NIK 8031414863983 lumen	1560 lm	

watt 12W
beam angle ↓ 90° + 90° ↑

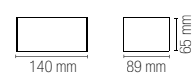

	colour temp.	colour
LED-W-TWIN-M BCO 8031414863969 lumen	2150 lm	
LED-W-TWIN-M ANT 8031414863693 lumen	2150 lm	
LED-W-TWIN-M NIK 8031414863990 lumen	2150 lm	

watt 20W
beam angle ↓ 90° + 90° ↑

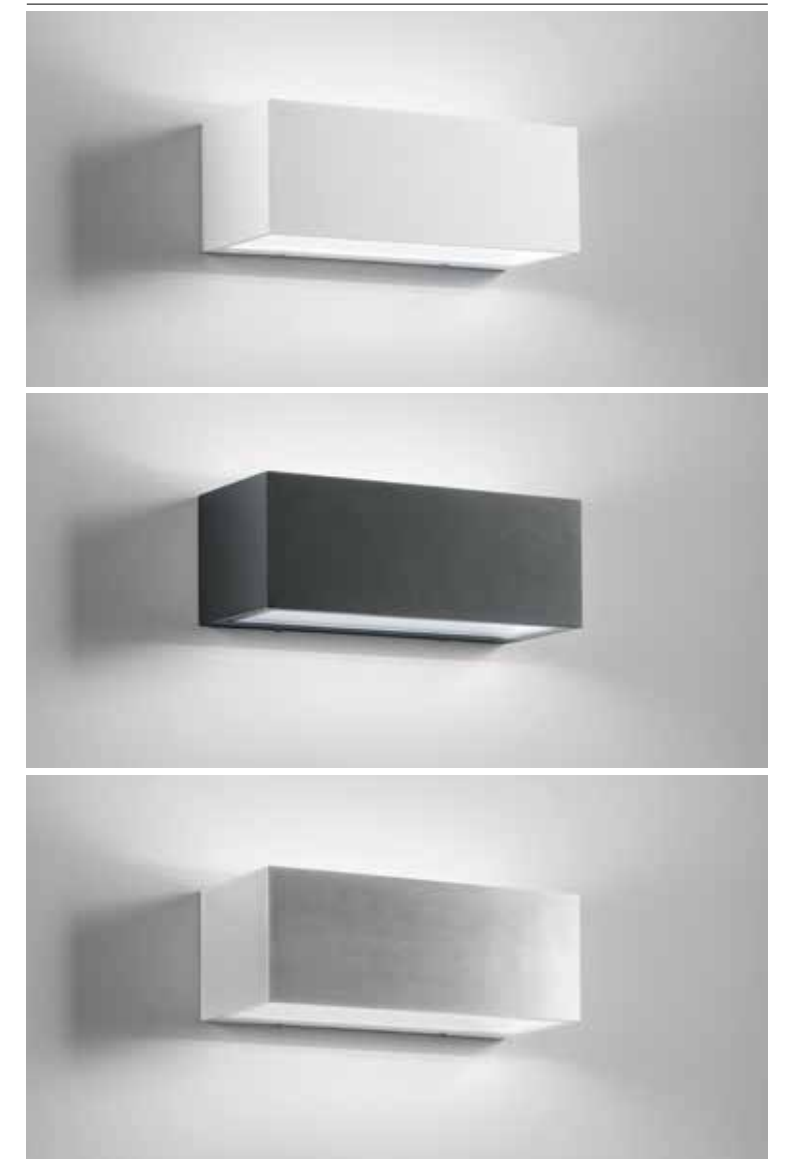

	colour temp.	colour
LED-W-TWIN-XL BCO 8031414863716 lumen	4440 lm	
LED-W-TWIN-XL ANT 8031414863686 lumen	4440 lm	
LED-W-TWIN-XL NIK 8031414864362 lumen	4440 lm	

watt 40W
beam angle ↓ 90° + 90° ↑

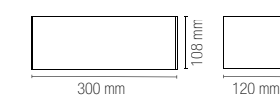

DUBAI

Applique a LED in alluminio con biemissione, emissione frontale con finitura bianco, antracite e bronzo.

LED aluminum wall lamp with double emission, frontal emission with white, anthracite and bronze finish.



technical information **DUBAI**



Materiale
alluminio

Colore
bianco opaco
antracite
corten



Temperatura colore selezionabile
3000K / 4000K



Driver
integrato

Material
aluminum

Colour
matt white
anthracite
corten



Selectable color temperature
3000K / 4000K



Driver
built-in



LED-W-DUBAI-BCO

8031414888115

lumen

colour temp. | colour



1280 lm

watt

10W

beam angle

↓ 120° + 120° ↑ + 180° →

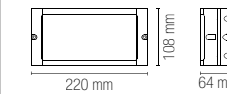

LED-W-DUBAI-ANT

8031414888108

lumen

colour temp. | colour



1280 lm

watt

10W

beam angle

↓ 120° + 120° ↑ + 180° →

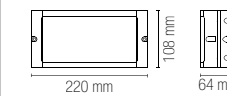

LED-W-DUBAI-BRO

8031414888122

lumen

colour temp. | colour



1280 lm

watt

10W

beam angle

↓ 120° + 120° ↑ + 180° →

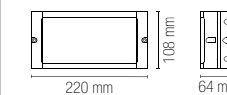

WEISS

Applique a LED in alluminio con finitura bianco, nero o corten.
Aluminum LED wall light in white, black and corten finish.

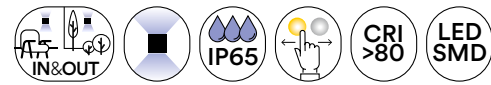

technical information **WEISS**



Materiale
alluminio

Colore
bianco
nero
corten



Temperatura colore selezionabile
3000K / 4000K



Driver
integrato

Material
aluminum

Colour
white
black
corten



Selectable color temperature
3000K / 4000K



Driver
built-in



LED-W-WEISS-BCO
8031414897193

lumen

colour temp. | colour



1800 lm

watt 16W
beam angle ↓ 120° + 120° ↑

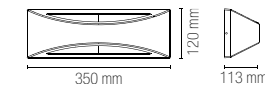

LED-W-WEISS-NER
8031414897216

lumen

colour temp. | colour



1800 lm

watt 16W
beam angle ↓ 120° + 120° ↑

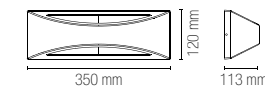

LED-W-WEISS-BRO
8031414897209

lumen

colour temp. | colour



1800 lm

watt 16W
beam angle ↓ 120° + 120° ↑

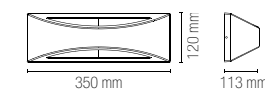

BORDER

Applique angolare a LED con struttura e diffusore in policarbonato e finitura bianco o nero opaco.

Angular LED wall lamp with structure and diffuser in PC and matt white and black finish.

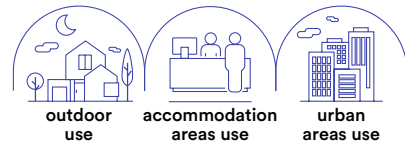

technical information **BORDER**



- Materiale**
PC
- Colore**
bianco opaco
nero opaco
- Temperatura colore**
4000K
- Driver**
incluso
- Material**
PC
- Colour**
matt white
matt black
- Colour temperature**
4000K
- Driver**
included



LED-BORDER-30M-BCO 8031414883578	colour temp.	colour
lumen	3550 lm	
watt	30W	
beam angle	120°	

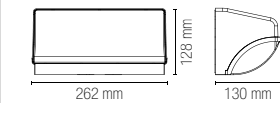

LED-BORDER-30M-ANT 8031414883561	colour temp.	colour
lumen	3550 lm	
watt	30W	
beam angle	120°	

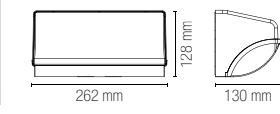

LUXON

Applique angolare a LED con struttura e diffusore in alluminio e finitura bianco gofrato.

Angular LED wall lamp with structure and diffuser in aluminum and embossed white and black finish.

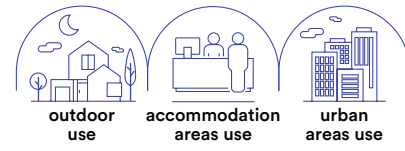

technical information **LUXON**



- Materiale**
alluminio

- Colore**
gofrato bianco
gofrato nero
-

- Temperatura colore selezionabile**
3000K / 4000K
-

- Driver**
incluso

- Material**
aluminum

- Colour**
embossed white
embossed black
-

- Selectable color temperature**
3000K / 4000K
-

- Driver**
included



	colour temp.	colour
LED-W-LUXON BCO 8031414870677	<input checked="" type="radio"/> <input type="radio"/> <input type="radio"/>	<input type="radio"/> <input type="radio"/> <input type="radio"/>
lumen	1550 lm	
watt	12W	
beam angle	120°	

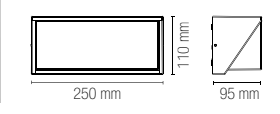

	colour temp.	colour
LED-W-LUXON ANT 8031414867097	<input checked="" type="radio"/> <input type="radio"/> <input type="radio"/>	<input type="radio"/> <input type="radio"/> <input checked="" type="radio"/>
lumen	1550 lm	
watt	12W	
beam angle	120°	

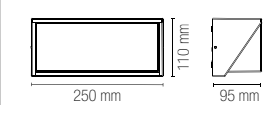

GRIS

Applique a LED in alluminio con finitura bianco o nera.
LED wall light in aluminum with white or black finish.

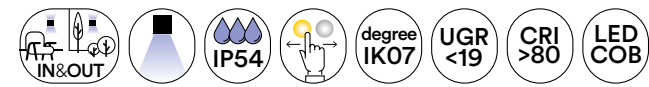

technical information **GRIS**



Materiale
alluminio

Colore
bianco
nero



Temperatura colore selezionabile
3000K / 4000K



Driver
integrato

Material
aluminum

Colour
white
black



Selectable color temperature
3000K / 4000K



Driver
built-in



LED-W-GRIS-BCO
8031414897223
lumen 1390 lm

colour temp. colour



watt 12W
beam angle 180°

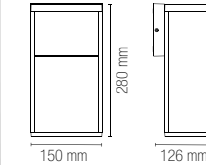

LED-W-GRIS-NER
8031414897230
lumen 1390 lm

colour temp. colour



watt 12W
beam angle 180°

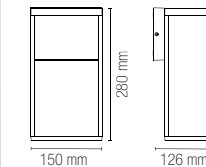

AGERA

Applique a LED in alluminio goffrato nero.
Aluminum LED wall lamp embossed black finish.

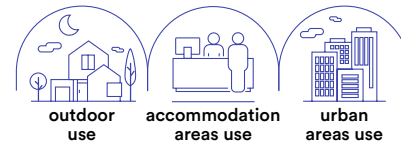

technical information **AGERA**



- Materiale**
alluminio
- Colore**
goffrato nero
- Temperatura colore**
4000K
- Driver**
incluso
- Material**
aluminum
- Colour**
embossed black
- Colour temperature**
4000K
- Driver**
included

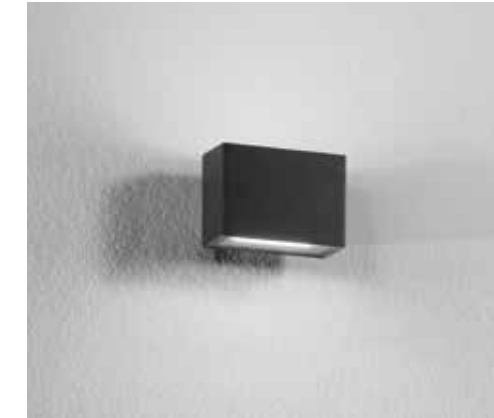

	colour temp.	colour
LED-W-AGERA-90 8031440360951	<input type="radio"/>	<input type="radio"/>
lumen	700 lm	
watt	2 x 3W	
beam angle	↓ 120° + 120° ↑	

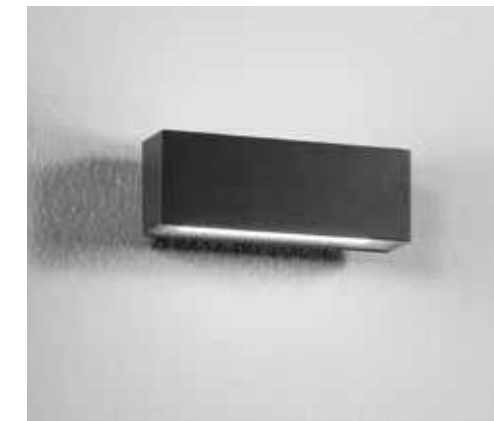
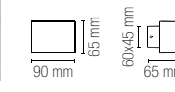

	colour temp.	colour
LED-W-AGERA-180 8031440360975	<input type="radio"/>	<input type="radio"/>
lumen	1440 lm	
watt	2 x 8W	
beam angle	↓ 120° + 120° ↑	

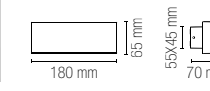

BOXTER

Applique a LED in alluminio goffrato bianco, silver, nero o corten.
Aluminum LED wall lamp embossed white, silver, black or corten finish.

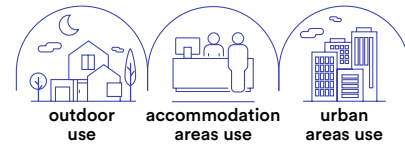

technical information **BOXTER**



- Materiale**
alluminio
- Colore**
bianco
silver
nero
corten
- Temperatura colore**
4000K
- Temperatura colore selezionabile**
3000K / 4000K
- Driver**
incluso
- Material**
aluminum
- Colour**
white
silver
black
corten
- Colour temperature**
4000K
- Selectable color temperature**
3000K / 4000K
- Driver**
included

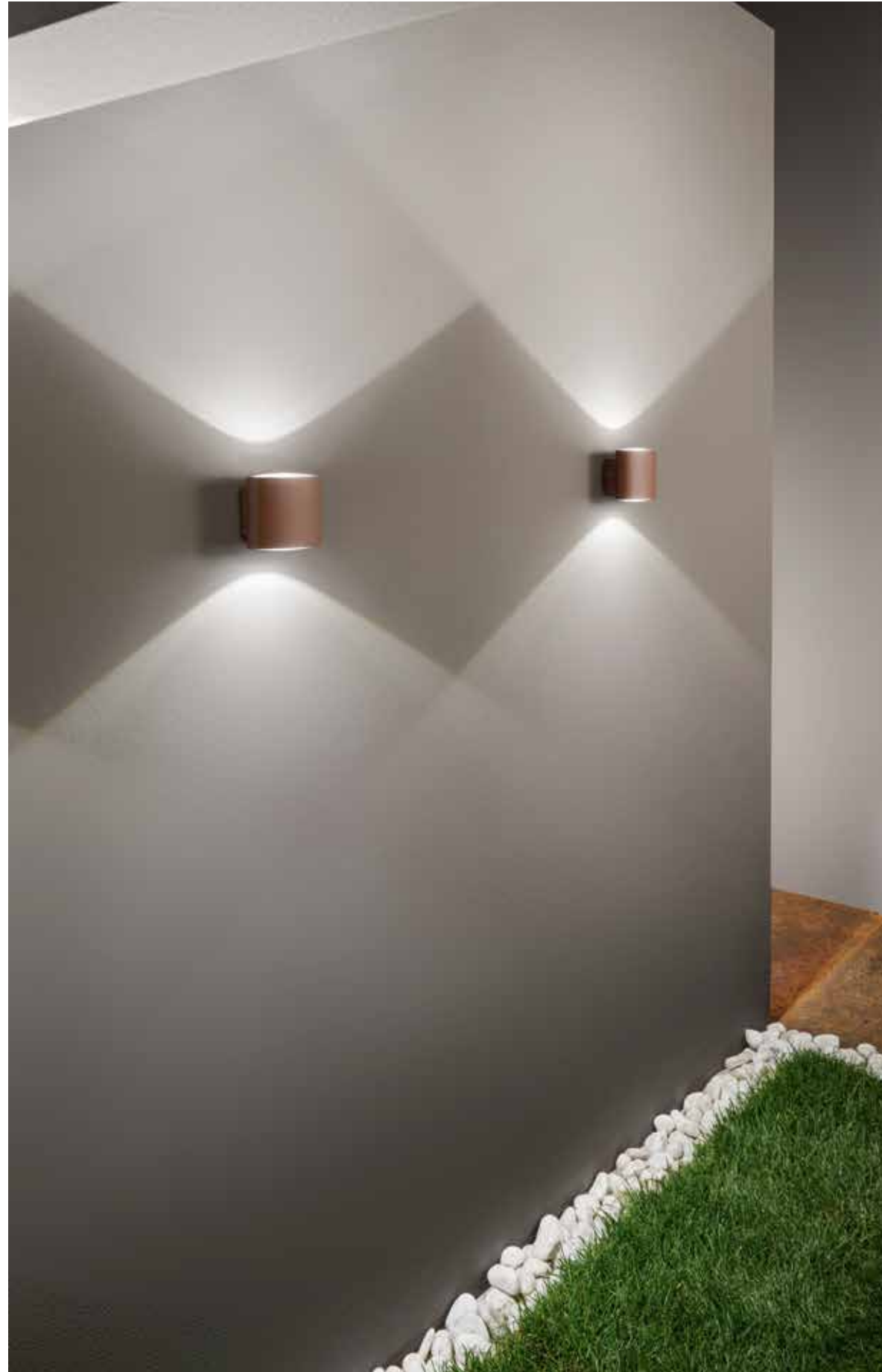

LED-W-BOXTER BCO
8031414873043
lumen 960 lm

watt 2 x 4W
beam angle ↓ 120° + 120° ↑

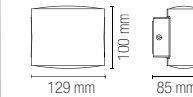

LED-W-BOXTER SIL
8031414862399
lumen 800 lm

watt 2 x 4W
beam angle ↓ 120° + 120° ↑

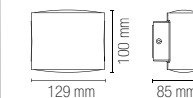

LED-W-BOXTER NER
8031414862382
lumen 960 lm

watt 2 x 4W
beam angle ↓ 120° + 120° ↑

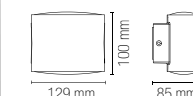

LED-W-BOXTER BRO
8031414862405
lumen 960 lm

watt 2 x 4W
beam angle ↓ 120° + 120° ↑

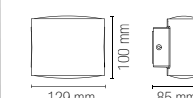

BEETLE

Applique a LED in alluminio bianco o antracite goffrato.
Aluminum LED wall lamp embossed white or anthracite finish.



technical information **BEETLE**



Materiale
alluminio

Colore
goffrato bianco
goffrato antracite



Temperatura colore selezionabile
3000K / 4000K



Driver
incluso

Material
aluminum

Colour
embossed white
embossed anthracite



Selectable color temperature
3000K / 4000K



Driver
included



LED-W-BEETLE BCO
8031414876952
lumen 600 lm

colour temp.	colour

watt	6W
beam angle	100°

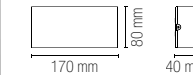

LED-W-BEETLE GR
8031414876969
lumen 600 lm

colour temp.	colour

watt	6W
beam angle	100°

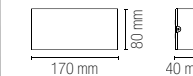

RIBBON

Fascia a LED in alluminio in antracite goffrato.
Aluminum LED applique in embossed anthracite finish.

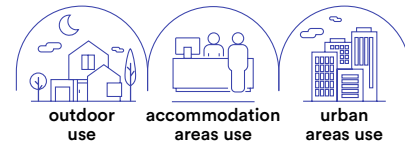

technical information **RIBBON**



- Materiale**
alluminio
- Colore**
goffrato antracite
- Temperatura colore**
4000K
- Driver**
incluso
- Material**
aluminum
- Colour**
embossed anthracite
- Colour temperature**
4000K
- Driver**
included



	colour temp.	colour
LED-RIBBON-42 8031414882335 lumen	<input type="radio"/>	<input type="radio"/>
	1600 lm	

watt	2 x 6W
beam angle	120°

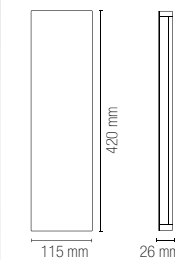

	colour temp.	colour
LED-RIBBON-72 8031414882342 lumen	<input type="radio"/>	<input type="radio"/>
	2600 lm	

watt	2 x 10W
beam angle	120°

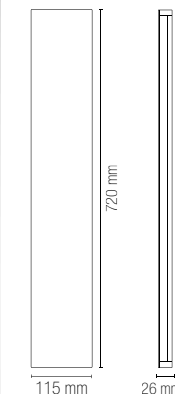

LASER

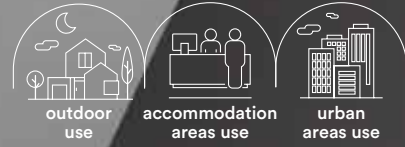

technical information **LASER**



Materiale
termoplastica

Colore
antracite



Temperatura colore
4000K



Driver
incluso

Material
thermoplastic

Colour
anthracite



Colour temperature
4000K



Driver
included

Applique a LED in termoplastica antracite.
LED wall lamp in thermoplastic anthracite.



	colour temp.	colour
LED-LASER 8031414882328		
lumen	170 lm	
watt	3W	
beam angle	5°	



	colour temp.	colour
LED-LASER-BIS 8031414882311		
lumen	40 lm	
watt	5W	
beam angle	2 x 4°	



In.tec light **OUTDOOR** APPLIQUE / WALL LAMPS

ALFA

Applique a LED in alluminio con
paratie regolabili indipendenti.
Aluminum LED wall lamp with
independent adjustable wings.



outdoor use accommodation areas use urban areas use

Materiale
alluminio

Colore
goffrato bianco
goffrato silver
goffrato antracite
goffrato corten



Temperatura colore
3000K / 4000K



Driver
incluso

Material
aluminum

Colour
embossed white
embossed silver
embossed anthracite
embossed corten



Colour temperature
3000K / 4000K



Driver
included

collection **ALFA**



In.tec light **OUTDOOR** APPLIQUE / WALL LAMPS

- Materiale**
alluminio
- Colore**
goffrato bianco
goffrato silver
- Temperatura colore**
3000K / 4000K
- Driver**
incluso
- Material**
aluminum
- Colour**
embossed white
embossed silver
- Colour temperature**
3000K / 4000K
- Driver**
included



	colour temp.	colour
LED-W-ALFA-10C BCO 8031414870851	700 lm	
LED-W-ALFA-10M BCO 8031414876686	740 lm	
watt	2 × 5W	
beam angle	↓ 10°/120° + 10°/120° ↑	

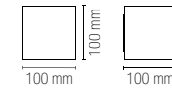

	colour temp.	colour
LED-W-ALFA-10C GR 8031414871346	700 lm	
LED-W-ALFA-10M GR 8031414876693	740 lm	
watt	2 × 5W	
beam angle	↓ 10°/120° + 10°/120° ↑	

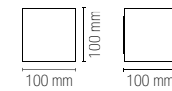

- Materiale**
alluminio
- Colore**
goffrato bianco
goffrato antracite
goffrato corten
- Temperatura colore**
3000K / 4000K
- Driver**
incluso
- Material**
aluminum
- Colour**
embossed white
embossed anthracite
embossed corten
- Colour temperature**
3000K / 4000K
- Driver**
included

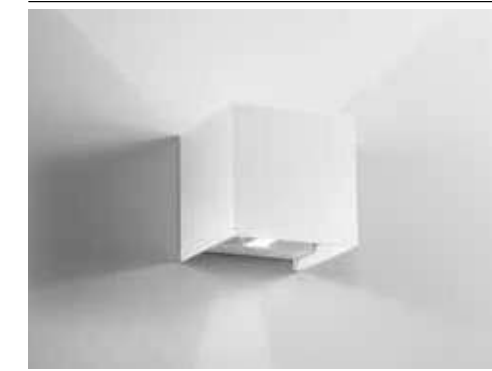

	colour temp.	colour
LED-W-ALFA-20C BCO 8031414883479	1360 lm	
LED-W-ALFA-20M BCO 8031414883486	1500 lm	
watt	20W	
beam angle	↓ 10°/120° + 10°/120° ↑	



	colour temp.	colour
LED-W-ALFA-20C ANT 8031414883455	1360 lm	
LED-W-ALFA-20M ANT 8031414883462	1500 lm	
watt	20W	
beam angle	↓ 10°/120° + 10°/120° ↑	



	colour temp.	colour
LED-W-ALFA-20C BRO 8031414883493	1360 lm	
LED-W-ALFA-20M BRO 8031414883509	1500 lm	
watt	20W	
beam angle	↓ 10°/120° + 10°/120° ↑	

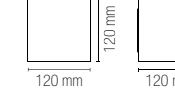

Luce biemissione con paratie regolabili indipendenti /
Bi-emission light with independent adjustable wings

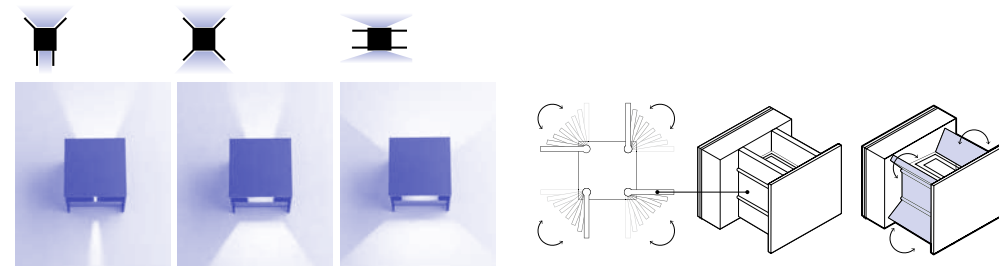

Luce biemissione con paratie regolabili indipendenti /
Bi-emission light with independent adjustable wings

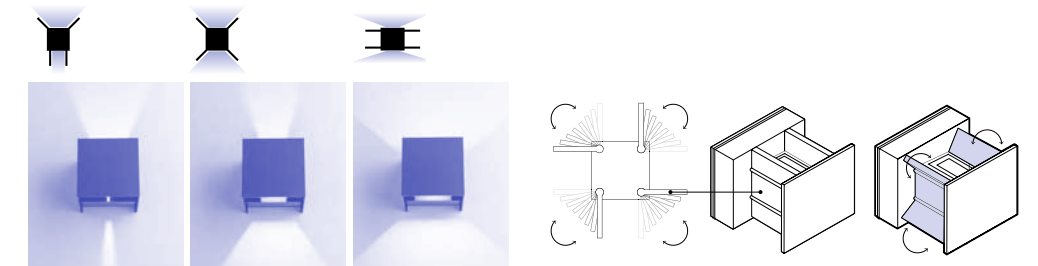

DELTA

Applique a LED in alluminio bianco o silver gofrato con paratie regolabili indipendenti.

Aluminum LED wall lamp in embossed white or silver finish with independent adjustable wings.



technical information **DELTA**



Materiale
alluminio

Colore
gofrato bianco
gofrato silver



Temperatura colore
3000K



Driver
incluso

Material
aluminum

Colour
embossed white
embossed silver



Colour temperature
3000K



Driver
included



LED-W-DELTA-10C BCO
8031414868537
lumen 700 lm



watt 2 x 5W
beam angle ↓ 10°/120° + 10°/120° ↑

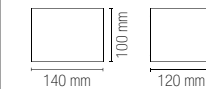

LED-W-DELTA-10C GR
8031414874125
lumen 700 lm



watt 2 x 5W
beam angle ↓ 10°/120° + 10°/120° ↑

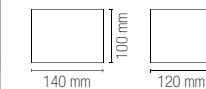

Luce biemissione con paratie regolabili indipendenti /
Bi-emission light with independent adjustable wings

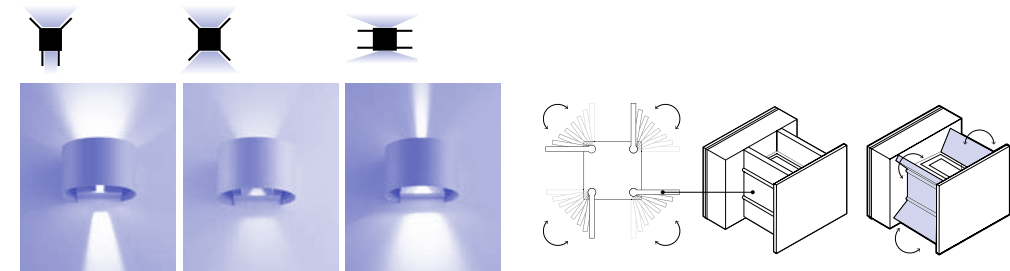

GHIBLI

Applique a LED in alluminio.
Aluminum LED wall lamp.



technical information **GHIBLI**

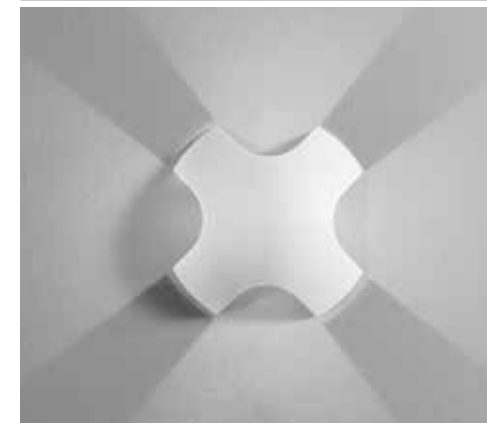

	colour temp.	colour
LED-W-GHIBLI/8W BCO 8031440360593		
lumen	520 lm	
watt	4 x 2W	
beam angle	4 x 120°	

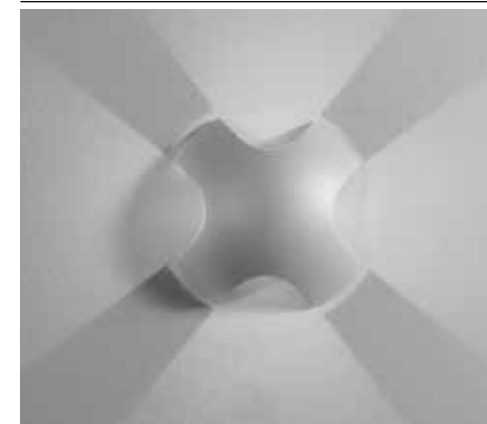

	colour temp.	colour
LED-W-GHIBLI/8W 8031440351430		
lumen	520 lm	
watt	4 x 2W	
beam angle	4 x 120°	



Materiale alluminio	Material aluminum
Colore gofrato bianco gofrato silver	Colour embossed white embossed silver
Temperatura colore 3000K	Colour temperature 3000K
Driver incluso	Driver included

PARKER

Applique a LED in cemento bianco o grigio naturale.
LED wall lamp in natural white or grey concrete.

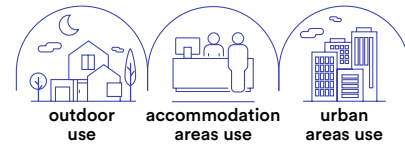

Materiale
cemento

Colore
bianco
grigio



Temperatura colore
4000K



Temperatura colore selezionabile
3000K / 4000K



Driver
incluso

Material
concrete

Colour
white
grey



Colour temperature
4000K



Selectable color temperature
3000K / 4000K



Driver
included



collection PARKER





LED-PARKER-AP30
8031414864195
lumen 1080 lm

colour temp.
 colour

watt 8W
beam angle $\downarrow 120^\circ + 120^\circ \uparrow$



Connettore IP65 incluso / IP65 connector included



Lampadina non inclusa / Light bulb not included

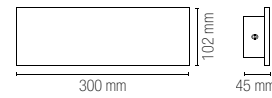

LED-PARKER-AP40
8031414864201
lumen 1400 lm

colour temp.
 colour

watt 12W
beam angle $\downarrow 120^\circ + 120^\circ \uparrow$



Connettore IP65 incluso / IP65 connector included



Lampadina non inclusa / Light bulb not included

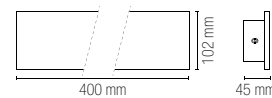

LED-PARKER-AP60
8031414862504
lumen 2400 lm

colour temp.
 colour

watt 20W
beam angle $\downarrow 120^\circ + 120^\circ \uparrow$



Connettore IP65 incluso / IP65 connector included



Lampadina non inclusa / Light bulb not included

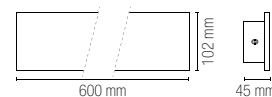

LED-PARKER-AP120
8031414862511
lumen 1500 lm

colour temp.
 colour

watt 30W
beam angle $\downarrow 120^\circ + 120^\circ \uparrow$



Connettore IP65 incluso / IP65 connector included



Lampadina non inclusa / Light bulb not included

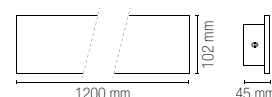

LED-PARKER-AP30 GR
8031414866977
lumen 1080 lm

colour temp.
 colour

watt 8,6W
beam angle $\downarrow 120^\circ + 120^\circ \uparrow$



Connettore IP65 incluso / IP65 connector included



Lampadina non inclusa / Light bulb not included

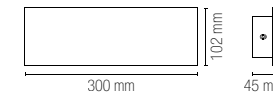

LED-PARKER-AP50 GR
8031414866984
lumen 2000 lm

colour temp.
 colour

watt 16,9W
beam angle $\downarrow 120^\circ + 120^\circ \uparrow$



Connettore IP65 incluso / IP65 connector included



Lampadina non inclusa / Light bulb not included

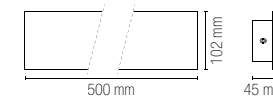

PORTLAND

Applique cilindrico in cemento bianco.
Cylindrical wall lamp in white concrete.

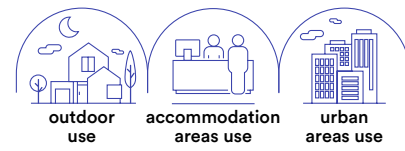

I-PORTLAND-AP2 BCO
8031414863563

2 x GU10 MAX 35W

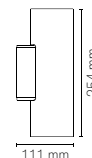

Connettore IP65 incluso /
IP65 connector included



Lampadina non inclusa /
Light bulb not included

OAKLAND

Applique in cemento bianco.
Wall lamp in white concrete.

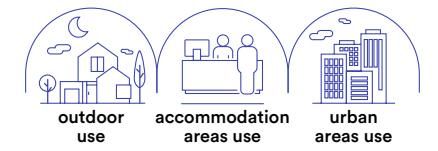

I-OAKLAND-AP2 BCO
8031414864218

2 x GU10 MAX 35W

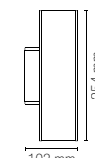

Connettore IP65 incluso /
IP65 connector included



Lampadina non inclusa /
Light bulb not included

JUMP

Applique in alluminio bianco, silver o in acciaio inox.
Wall lamp aluminum white, silver finish or stainless steel.

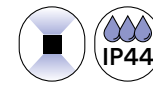
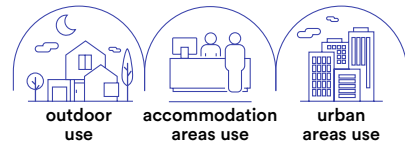

technical information **JUMP**



	colour
I-JUMP-AP2 BCO 8031414862351	
I-JUMP-AP2 SIL 8031414862344	
I-JUMP-AP2 INOX 8031414862368	

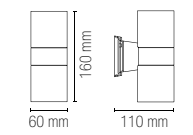

Lampadina non inclusa / Light bulb not included

2 x GU10 MAX 35W



	colour
I-JUMP-AP2-E27 SIL 8031414865390	

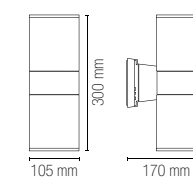

Lampadina non inclusa / Light bulb not included

2XE27 MAX 60W

OUTDOOR APPLIQUE / WALL LAMPS

In.tec light

ONE

Applique a LED in alluminio con singola o doppia
emissione bianco, antracite o corten gofrato.

Aluminum LED wall light with single or double emission
in embossed white, anthracite or corten.

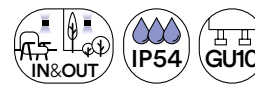

technical information **ONE**



	colour	
I-ONE-AP1 BCO 8031414878857		
I-ONE-AP1 ANT 8031414073009		
I-ONE-AP1 BRO 8031414048861		
1 x GU10 MAX 35W		

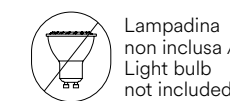

Lampadina
non inclusa /
Light bulb
not included



	colour	
I-ONE-AP2 BCO 8031414878864		
I-ONE-AP2 ANT 8031414082100		
I-ONE-AP2 BRO 8031414079995		
2 x GU10 MAX 35W		

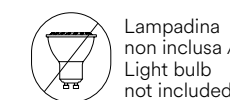

Lampadina
non inclusa /
Light bulb
not included

QUBO

Applique a LED in alluminio con singola o doppia emissione bianco, antracite o corten goffrato.
Aluminum LED wall light with single or double emission in embossed white, anthracite or corten.

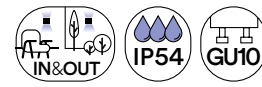

technical information **QUBO**



	colour	
I-QUBO-AP1 BCO 8031414878833		
I-QUBO-AP1 ANT 80314144084203		
I-QUBO-AP1 BRO 80314144082117		
1 x GU10 MAX 35W		



	colour	
I-QUBO-AP2 BCO 8031414878840		
I-QUBO-AP2 ANT 80314144084289		
I-QUBO-AP2 BRO 80314144083336		
2 x GU10 MAX 35W		



OUTDOOR APPLIQUE / WALL LAMPS

In.tec light

TUCSON

Applique in alluminio bianco, silver o bronzo gofrato con diffusore in policarbonato.
Aluminum wall lamp in embossed white, silver or bronze PC diffuser.

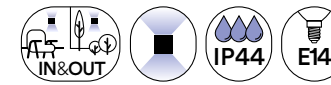

technical information **TUCSON**



colour ●

I-TUCSON-AP BCO
8031414862160

2 x E14 MAX 40W

- Lampadina consigliata / Suggested light bulb
- Lampadina non inclusa / Light bulb not included

colour ●

I-TUCSON-AP SIL
8031414862184

2 x E14 MAX 40W

- Lampadina consigliata / Suggested light bulb
- Lampadina non inclusa / Light bulb not included

colour ●

I-TUCSON-AP BRO
8031414862191

2 x E14 MAX 40W

- Lampadina consigliata / Suggested light bulb
- Lampadina non inclusa / Light bulb not included

HURACAN

Applique in alluminio pressofuso antracite gofrato.
Aluminum die-cast wall lamp embossed anthracite finish.



I-HURACAN-AP
8031440361026

colour
●

1 x GU10 MAX 35W

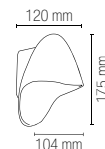

Lampadina non inclusa /
Light bulb not included

SEATTLE

Applique in alluminio, finitura antracite
con diffusore opale in policarbonato.
Aluminum wall lamp with anthracite
finish and PC opal diffuser.



I-SEATTLE-AP
8031440312233

colour
●

1 x E27 MAX 42W

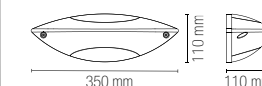

Lampadina non inclusa /
Light bulb not included

AUSTIN

Applique in alluminio bianco, silver, nero o bronzo con diffusore in policarbonato.
Aluminum wall lamp white, silver, black or bronze PC diffuser.

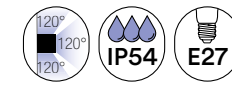
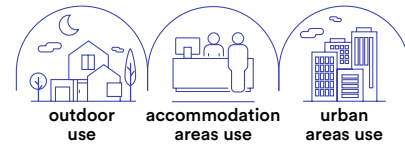

technical information **AUSTIN**



I-AUSTIN-AP BCO
8031440362122

1 x E27 MAX 42W

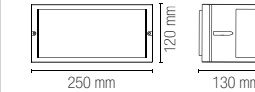

colour



Lampadina non inclusa /
Light bulb not included



I-AUSTIN-AP SIL
8031414862429

1 x E27 MAX 42W

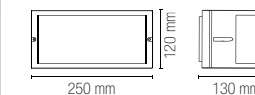

colour



Lampadina non inclusa /
Light bulb not included



I-AUSTIN-AP NER
8031440362139

1 x E27 MAX 42W

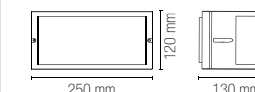

colour



Lampadina non inclusa /
Light bulb not included



I-AUSTIN-AP BRO
8031440362108

1 x E27 MAX 42W

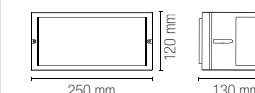

colour



Lampadina non inclusa /
Light bulb not included

BOSTON

Applique in alluminio finitura antracite con diffusore opale in policarbonato.

Aluminum wall lamp anthracite finish with PC opal diffuser.



colour

I-BOSTON-AP
8031440312240

1 x E27 MAX 42W

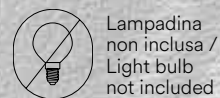
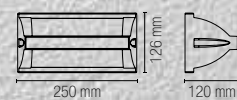

ATLANTA

Applique in alluminio finitura antracite con diffusore opale in policarbonato.

Aluminum wall lamp anthracite finish with PC opal diffuser.

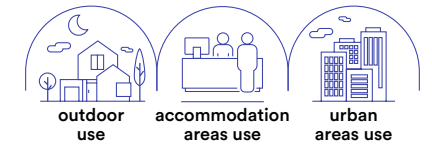

colour

I-ATLANTA-AP
8031440312257

1 x E27 MAX 42W

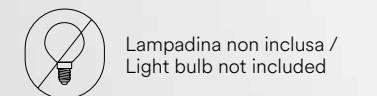
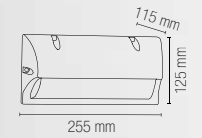

DENVER

Applique in alluminio finitura antracite con diffusore opale in policarbonato.

Aluminum wall lamp anthracite finish with PC opal diffuser.



colour

I-DENVER-AP
8031440312264

1 x E27 MAX 42W

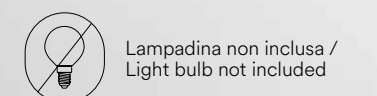
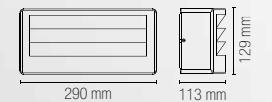

MONDRIAN

Applique in metallo bianco, nero, silver o bronzo con diffusore in vetro.
Metal wall lamp white, black, silver or bronze glass diffuser.



- | | colour |
|---|--------|
| I-MONDRIAN-AP BCO
8031414896134 | |
| I-MONDRIAN-AP SIL
8031414862306 | |
| I-MONDRIAN-AP NER
8031414896127 | |
| I-MONDRIAN-AP BRO
8031414862313 | |

2 x E27 MAX 25W

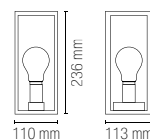

Lampadina non inclusa / Light bulb not included

GAETA

Lanterna in alluminio pressofuso finitura nero-oro con diffusore in vetro.
Diecast aluminum black-gold finish lantern with glass diffuser.

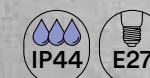

- | | |
|--|--|
| LANT-GAETA-AP1
8031440313278 | |
|--|--|

1 x E27 MAX 60W

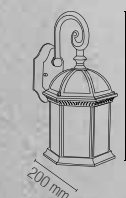

Lampadina non inclusa / Light bulb not included

GRUBB

Proiettore in termoplastica picchetto incluso.
Thermoplastic flood light with spike included.



AKRON

Proiettore in alluminio con picchetto incluso.
Aluminum flood light with spike included.



colour	●
LED-GRUBB-7M 8031414883554	
1 x E27	

Accessori inclusi / Included accessories	
	Lampadina LED SMD / LED SMD light bulb
watt	7W
beam angle	100°
cri	80
on/off	>10.000
durata/life time	25000h
4000K	
lumen	510 lm
dimmer	



colour	●
LED-GRUBB-15M 8031414883547	
1 x E27	

Accessori inclusi / Included accessories	
	Lampadina LED SMD / LED SMD light bulb
watt	15W
beam angle	100°
cri	80
on/off	>10.000
durata/life time	25000h
4000K	
lumen	1100 lm
dimmer	



colour	●
I-AKRON-BCO 8031414882649	
I-AKRON-NER 8031414882663	●
I-AKRON-BRO 8031414882656	●
1 x GU10 MAX 35W	

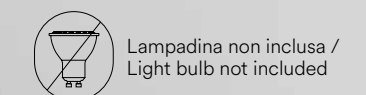

Lampadina non inclusa /
Light bulb not included

OUTDOOR APPLIQUE / WALL LAMPS
In-tec light



technical information **PEG**



Materiale
PC

Colore
nero



Temperatura colore
3000K / 4000K



Driver
integrato

Material
PC

Colour
black



Colour temperature
3000K / 4000K



Driver
built-in

Proiettore in termoplastica con picchetto incluso.
Termoplastic flood light with spike included.



	colour temp.	colour
LED-PEG-9C-NER 8031414889600 lumen		
	800 lm	
LED-PEG-9M-NER 8031414895403 lumen		
	800 lm	
watt	9W	
beam angle	60°	

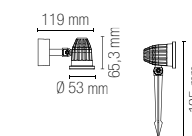

TOGO

Plafoniera a LED in acrilico.
LED acrylic ceiling lamp with diffuser.



Materiale
Acrilico PMMA

Colore
bianco



**Temperatura colore
selezionabile**
3000K / 4000K / 6500K



Driver
integrato

Material
PMMA acrylic

Colour
white



**Selectable color
temperature**
3000K / 4000K / 6500K



Driver
built-in driver

collection **TOGO**



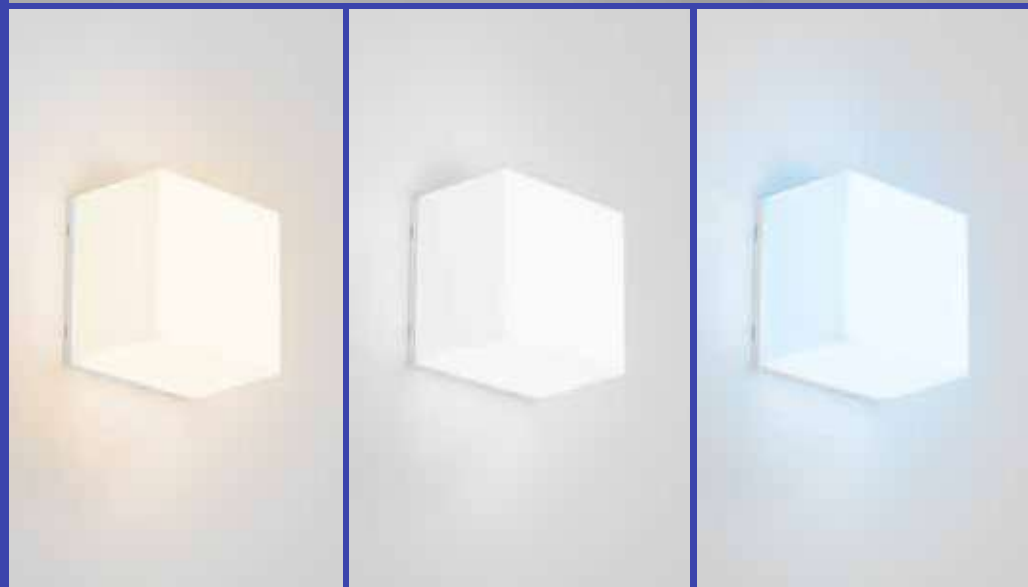

LED-TOGO-Q10
8031414883615
lumen 600 lm

colour temp. colour

watt 5W
beam angle 120°

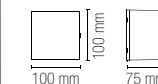

LED-TOGO-Q25
8031414883646
lumen 2400 lm

colour temp. colour

watt 20W
beam angle 120°

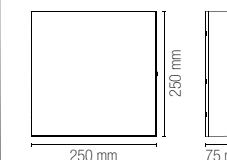

LED-TOGO-RT20
8031414883622
lumen 1000 lm

colour temp. colour

watt 8W
beam angle 120°

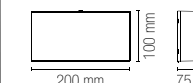

LED-TOGO-RT30
8031414883639
lumen 1500 lm

colour temp. colour

watt 12W
beam angle 120°



OUTDOOR

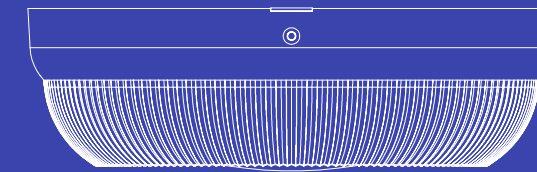

PLAFONIERE

CEILING LAMPS

ZOOM

Plafoniera a LED wifi con videocamera di sicurezza integrata.
LED wifi ceiling lamp with built-in security camera.

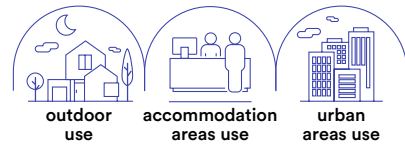

technical information ZOOM



- Materiale**
alluminio + PC
- Colore**
goffrato antracite
- Temperatura colore**
4000K
- Driver**
integrato
- Material**
aluminium + PC
- Colour**
Embossed anthracite
- Colour temperature**
4000K
- Driver**
built-in



LED-ZOOM-INT 8031414877874	colour temp.	colour
lumen	3600 lm	
watt	30W	
beam angle	110°	
pf	0.95	

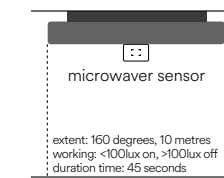
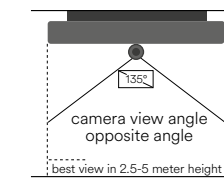
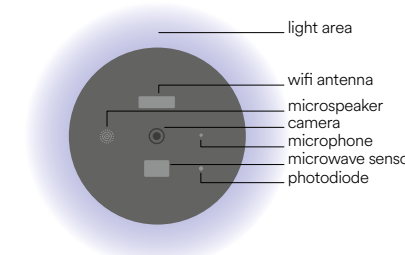
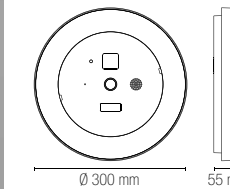

Tipo di sensore video Video sensor type	1/2,9" CMOS
Pixel	2.0 Mega
Illuminazione minima Min illuminance	Color 0.10lux @F2.0, black and white 0.01lux @F2.0
Angolo vista camera Camera view angle	135°
Otturatore Shutter	1/25-1/100,000 per second
Infrarossi IR	High power LED with ICR
WDR	Digital WDR
Video compression standard	H.264 32Kbps - 2Mbps
Risoluzione video Max picture size	1920x1080
Frequenza fotogrammi Frame rate	1-20 per second
Audio	Full duplex audio (doppio sistema di comunicazione)
Memoria	Support SD card (MAX 128Gb) Cloud storage NVR
Impostazione immagine Image setting	Support HD/SD; support mirror
Reset	Support
Controllo della luce Lighting control	Support manual, sensor, plan switch light (gestione accensioni)
Interfaccia di protocollo Interface protocol	Private
Comunicazione di protocollo Communication protocol	TCP/IP, HTTP, DHCP, DNS, RTSP
Funzioni generali General function	Dual stream, password protection
Wi-Fi	IEEE802.11b/g/n
PIR	Support PIR and motion detection

Control system easy installation

Full duplex audio

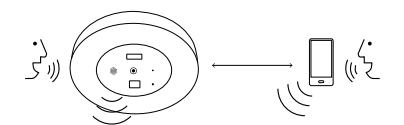

OUTDOOR PLAFONIERE / CEILING LAMPS

In.tec light

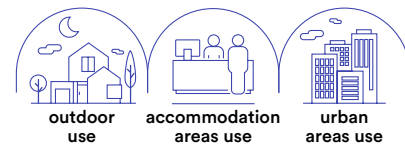

Materiale
alluminio + PMMA

Colore
antracite



Temperatura colore
CCT



Driver
incluso

Material
aluminium + PMMA

Colour
anthracite



Colour temperature
CCT



Driver
included



LED-TUTOR-INT 8031414870165	colour temp.	colour
lumen	600 lm	
watt	10W	
beam angle	120°	



Control system easy installation



Smart Intec WIFI



RF 2.4G control system



ALEXA e GOOGLE HOME voice control

VERTIGO

Plafoniera in cemento bianco o grigio.
Concrete ceiling lamp white or gray.



technical information **VERTIGO**



Materiale
cemento

Colore
bianco
grigio



Temperatura colore
4000K



Driver
incluso

Material
concrete

Colour
white
grey



Colour temperature
4000K



Driver
included



LED-VERTIGO-R23
8031414867141
lumen

colour temp.	colour
500 lm	

watt 10W
beam angle 120°

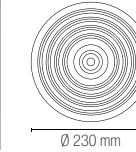
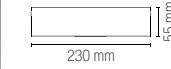

Connettore IP65 incluso /
IP65 connector included



LED-VERTIGO-Q23
8031414867134
lumen

colour temp.	colour
500 lm	

watt 10W
beam angle 120°

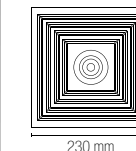
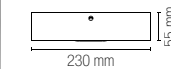

Connettore IP65 incluso /
IP65 connector included

CITIZEN

Plafoniera in alluminio nelle versioni bianco, nero o corten.
Ceiling wall lamp white, black or corten finish.

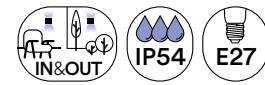

technical information **CITIZEN**



colour

I-CITIZEN-Q1-BCO

8031414882922

I-CITIZEN-Q1-NER

8031414882939

I-CITIZEN-Q1-BRO

8031414882915



1 x E27

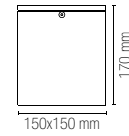

Lampadina non inclusa / Light bulb not included



colour

I-CITIZEN-R1-BCO

8031414882892

I-CITIZEN-R1-NER

8031414882908

I-CITIZEN-R1-BRO

8031414882885



1 x E27

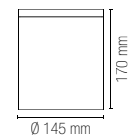

Lampadina non inclusa / Light bulb not included

ISCHIA

Plafoniera LED integrato, in termoplastica bianco con diffusore trasparente effetto diamantato.

Thermoplastic LED ceiling lamp with transparent diamond effect diffuser.

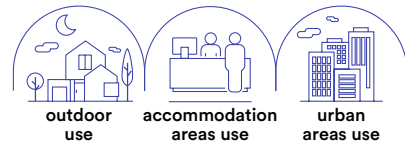

Materiale
termoplastica



Temperatura colore

4000K



Driver
integrato

Material
thermoplastic

Colour temperature

4000K



Driver
built-in



LED-ISCHIA-L-BCO

8031414883608

lumen

colour temp.



colour



2300 lm

watt

20W

beam angle

100°

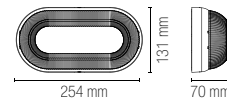

CAPRI

Plafoniera LED integrato, in termoplastica bianco con diffusore trasparente effetto diamantato.

Thermoplastic LED ceiling lamp with transparent diamond effect diffuser.



Materiale
termoplastica



Temperatura colore

4000K



Driver
integrato

Material
thermoplastic

Colour temperature

4000K



Driver
built-in



LED-CAPRI-S-BCO

8031414883585

lumen

colour temp.



colour



2350 lm

watt

20W

beam angle

100°

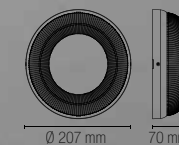

LED-CAPRI-L-BCO

8031414883592

lumen

colour temp.



colour



3200 lm

watt

30W

beam angle

100°

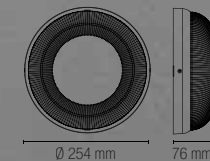

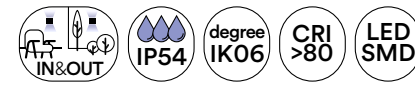

Materiale

PP + PC

Colore

bianco
antracite



Temperatura colore

3000K / 4000K



Driver

integrato

Material

PP + PC

Colour

white
anthracite



Colour temperature

3000K / 4000K



Driver

built-in

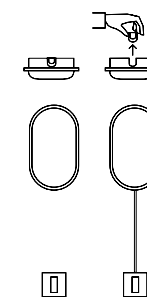

Doppio sistema di installazione / Double installation system

Plafoniera LED integrato con sensore di movimento; materiale base in PP bianco o antracite con diffusore bianco PC.

LED ceiling lamp with motion sensor; PP white base or anthracite colour with white PC diffuser.



Accessori inclusi / Included accessories

Sensore di movimento regolabile / Adjustable motion sensor

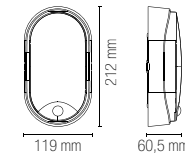
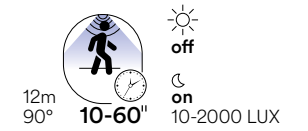

	colour temp.	colour
LED-SENSITIVE-C BCO 8031414876815 lumen		
	1000 lm	
LED-SENSITIVE-BCO 8031440361750 lumen		
	1600 lm	
LED-SENSITIVE-ANT 8031440361743 lumen		
	1600	
watt	14W	
beam angle	120°	



Materiale

PP + PC

Colore

bianco
antracite



Temperatura colore

4000K



Driver

integrato

Material

PP + PC

Colour

white
anthracite



Colour temperature

4000K



Driver

built-in

Plafoniera LED integrato materiale base PP bianco con diffusore bianco PC adatte ad installazione con impianto canaline esterne.
Ceiling LED integrated white PP base material with white PC diffuser fit for surface mount cable ducts connections.

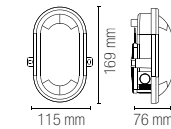

	colour temp.	colour
LED-EXTRA-BCO 8031440361071		
lumen	1100 lm	
LED-EXTRA-ANT 8031440361064		
lumen	1100 lm	
watt	10W	
beam angle	120°	

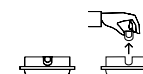

Doppio sistema di installazione /
Double installation system

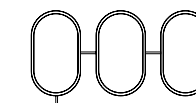
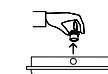

Adatte ad installazione con impianto canaline esterne /
Surface mount cable ducts connections



Materiale
PC + PC

Colore
bianco
antracite



Temperatura colore
4000K



Driver
integrato

Material
PC + PC

Colour
white
anthracite



Colour temperature
4000K



Driver
built-in

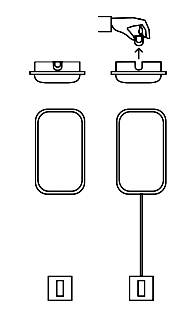

Doppio sistema di installazione / Double installation system

Plafoniera LED integrato con sensore, base in policarbonato bianco o antracite diffusore in policarbonato bianco.

Polycarbonate built-in LED ceiling lamp with sensor in white or anthracite colour with white PC diffuser.



Accessori inclusi / Included accessories

Sensore di movimento regolabile / Adjustable motion sensor

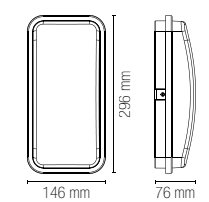
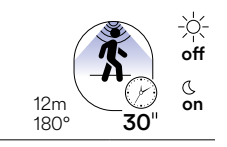

	colour temp.	colour
LED-SHELLY-Q-MW BCO 8031414862153		
lumen	2500 lm	
LED-SHELLY-Q-MW ANT 8031414862177		
lumen	2500 lm	
watt	20W	
beam angle	120°	

Materiale

PC + PC

Colore

bianco
antracite



Temperatura colore

3000K / 4000K



Driver

integrato

Material

PC + PC

Colour

white
anthracite



Colour temperature

3000K / 4000K



Driver

built-in

Plafoniera LED integrato, base in policarbonato bianco o antracite diffusore in policarbonato bianco.
Polycarbonate built-in LED ceiling lamp in white or anthracite colour with white PC diffuser.



	colour temp.	colour
LED-SHELLY-Q-SC BCO 8031414876730		
lumen	1200 lm	
LED-SHELLY-Q-S BCO 8031414085507		
lumen	1900 lm	
LED-SHELLY-Q-S ANT 8031414862009		
lumen	1900 lm	

	colour temp.	colour
LED-SHELLY-Q-LC BCO 8031414876747		
lumen	1600 lm	
LED-SHELLY-Q-L BCO 8031414862016		
lumen	2500 lm	
LED-SHELLY-Q-L ANT 8031414862023		
lumen	2500 lm	

watt 15W
beam angle 120°

watt 20W
beam angle 120°

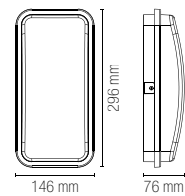
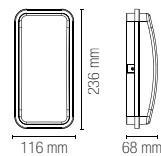

Materiale

PC + PC

Colore

bianco
antracite



Temperatura colore

3000K / 4000K



Driver

integrato

Material

PC + PC

Colour

white
anthracite



Colour temperature

3000K / 4000K



Driver

built-in

Plafoniera LED integrato, base in policarbonato bianco o antracite diffusore in policarbonato bianco.
Polycarbonate built-in LED ceiling lamp in white or anthracite colour with white PC diffuser.



	colour temp.	colour
LED-SHELLY-SC BCO 8031414876761		
lumen	1900 lm	
LED-SHELLY-S BCO 8031440351720		
lumen	1900 lm	
LED-SHELLY-S ANT 8031440351706		
lumen	1900 lm	

	colour temp.	colour
LED-SHELLY-LC BCO 8031414876716		
lumen	2500 lm	
LED-SHELLY-L BCO 8031440351713		
lumen	2500 lm	
LED-SHELLY-L ANT 8031440351690		
lumen	2500 lm	

watt 15W
beam angle 120°

watt 20W
beam angle 120°

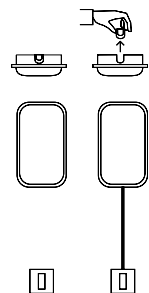
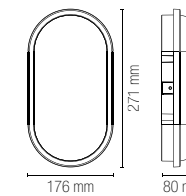
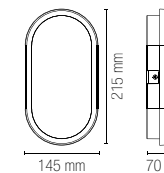

Doppio sistema di installazione / Double installation system

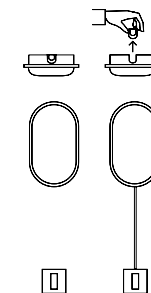

Doppio sistema di installazione / Double installation system



Materiale

PC + PC

Colore

bianco
antracite



Temperatura colore

3000K / 4000K



Driver

integrato

Material

PC + PC

Colour

white
anthracite



Colour temperature

3000K / 4000K



Driver

built-in

Plafoniera LED integrato, base in policarbonato bianco o antracite, diffusore in policarbonato bianco.
Polycarbonate built-in LED ceiling lamp in white or anthracite colour with white PC diffuser.



	colour temp.	colour
LED-EVER-Q-SC BCO 8031414876778		
lumen	1900 lm	
LED-EVER-Q-S BCO 8031414862238		
lumen	1900 lm	
LED-EVER-Q-S ANT 8031414862269		
lumen	1900 lm	

watt	15W
beam angle	120°
pf	-

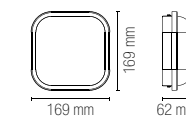

	colour temp.	colour
LED-EVER-Q-LC BCO 8031414876785		
lumen	3420	
LED-EVER-Q-L BCO 8031414862276		
lumen	3420	
LED-EVER-Q-L ANT 8031414862283		
lumen	3420	

watt	30W
beam angle	120°
pf	0.90

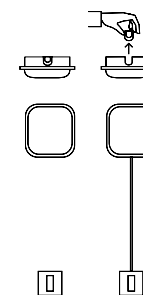
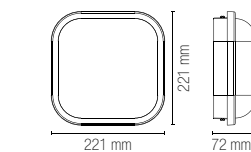

Doppio sistema di installazione / Double installation system

Materiale

PC + PC

Colore

bianco
antracite



Temperatura colore

4000K



Driver

integrato

Material

PC + PC

Colour

white
anthracite



Colour temperature

4000K



Driver

built-in

Plafoniera LED integrato, base in policarbonato bianco o antracite, diffusore in policarbonato bianco.
Polycarbonate built-in LED ceiling lamp in white or anthracite colour with white PC diffuser.



LED-EVER-LP BCO
8031440355650
lumen 2500 lm

watt 20W
beam angle 120°
pf -

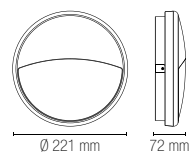

LED-EVER-XLP BCO
8031440355636
lumen 3750 lm

watt 30W
beam angle 120°
pf 0.90

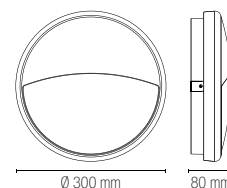

Materiale

PC + PC

Colore

bianco
antracite



Temperatura colore

3000K / 4000K



Driver

integrato

Material

PC + PC

Colour

white
anthracite



Colour temperature

3000K / 4000K



Driver

built-in

Plafoniera LED integrato, base in policarbonato bianco o antracite, diffusore in policarbonato bianco.
Polycarbonate built-in LED ceiling lamp in white or anthracite colour with white PC diffuser.

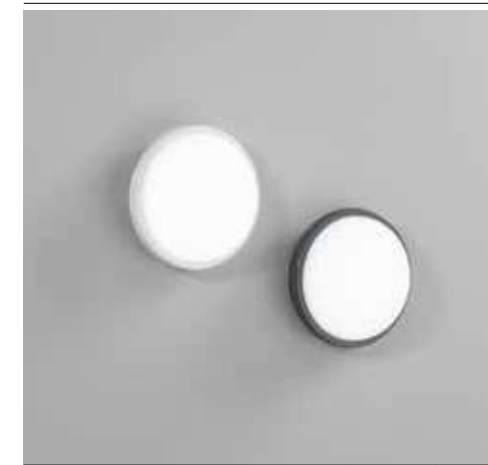

LED-EVER-SC BCO
8031414876808
lumen 1900 lm

watt 15W
beam angle 120°
pf -

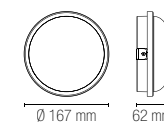

LED-EVER-LC BCO
8031414876754
lumen 2500 lm

watt 20W
beam angle 120°
pf 0.90

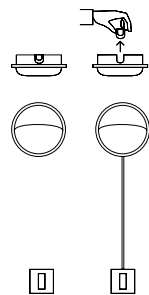
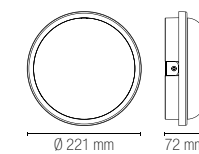

Doppio sistema di installazione / Double installation system

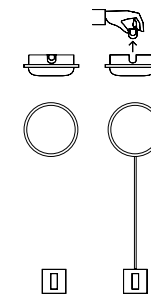

Doppio sistema di installazione / Double installation system

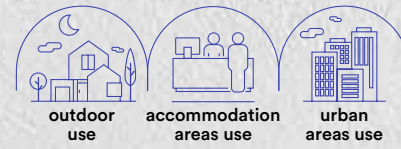

Materiale
PC + PC

Colore
bianco
silver



Temperatura colore
3000K / 4000K



Driver
integrato

Material
PC + PC

Colour
white
silver



Colour temperature
3000K / 4000K



Driver
built-in

Plafoniera LED integrato, base policarbonato bianco o silver con diffusore in policarbonato bianco.
Polycarbonate built-in LED ceiling lamp PC base white or silver with white PC diffuser.



	colour temp.	colour
LED-EVER-XLC BCO 8031414876792 lumen		
	3750 lm	
LED-EVER-XL BCO 8031440355612 lumen		
	3750 lm	
LED-EVER-XL SIL 8031440355605 lumen		
	3750 lm	
watt	30W	
beam angle	120°	
pf	0.90	

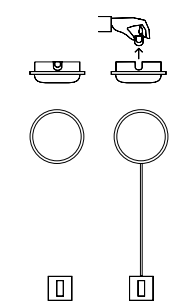
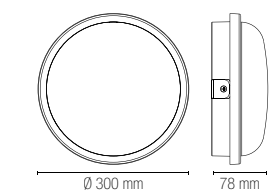

Doppio sistema di installazione / Double installation system

Materiale
PC + PC

Colore
bianco
silver



Temperatura colore
4000K



Driver
integrato

Material
PC + PC

Colour
white
silver



Colour temperature
4000K



Driver
built-in

Plafoniera con sensore di movimento microwave, base in policarbonato, diffusore in policarbonato bianco.
Ceiling lamp with microwave sensor in polycarbonate ceiling with white PC diffuser.



	colour temp.	colour
LED-EVER-XL-MW BCO 8031414862375 lumen		
	3750 lm	
LED-EVER-XL-MW SIL 8031414862610 lumen		
	3750 lm	
watt	30W	
beam angle	120°	
pf	0.90	

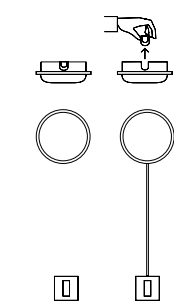
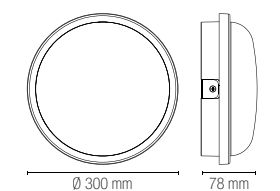

Doppio sistema di installazione / Double installation system

Accessori inclusi / Included accessories

Sensore di movimento regolabile / Adjustable motion sensor

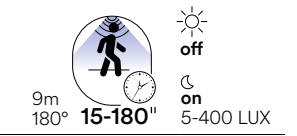

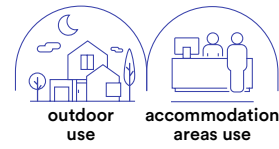

Materiale
PC + PVC

Colore
nero

Temperatura colore
RGB + CCT



Driver
integrato

Material
PC + PVC

Colour
black

Colour temperature
RGB + CCT



Driver
built-in

Stringa elettrificata a LED per esterno con cavo in PVC inclusa di spina schuko e connettore modulare.
LED light string with PVC cable inclusive of schuko plug and modular connector.



I-PICNIC-INT
8031414884391
lumen

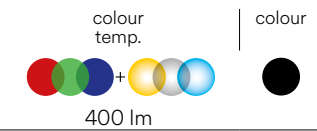

watt 0,5 x 10W
beam angle 110°

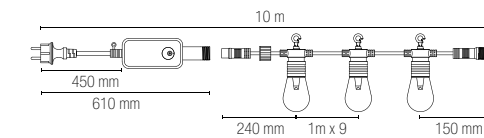

END-TO-END
easy connection / max 1000W

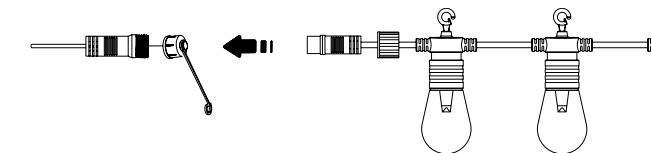

Control system easy installation



Stringa elettrificata E12 per esterno con cavo in PVC inclusiva di spina schuko e connettore modulare.
Light string E12 PVC cable inclusive of schuko plug and modular connector.



Stringa elettrificata E12 per esterno con cavo in PVC inclusiva di pannello solare.
Light string E12 PVC cable inclusive solar panel.

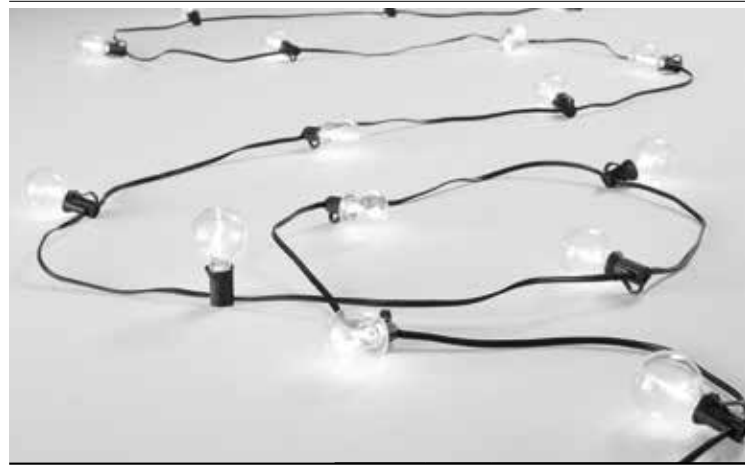
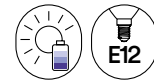

colour | Accessori inclusi / Included accessories

colour | Accessori inclusi / Included accessories

I-PICNIC-LED
8031414884407



Lampadina E12
E12 light bulb

watt	0,3W
volt	230V
3000K	

I-PICNIC-SOLAR
8031414884414



Lampadina E12
E12 light bulb

watt	0,3W
volt	3V
3000K	

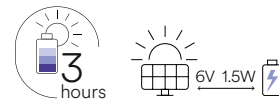

3.7V 2200mAh
Batteria ricaricabile non sostituibile / Rechargeable battery non replaceable

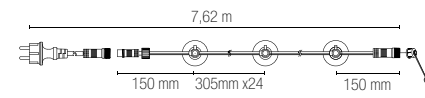
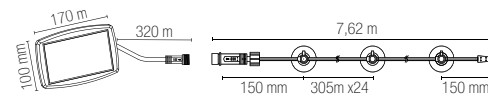

END-TO-END
easy connection / max 1000W

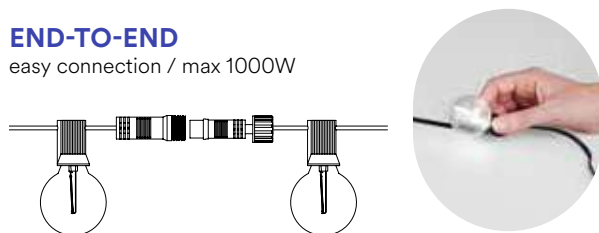

Stringa elettrificata E14 o E27 per esterno con cavo in gomma inclusiva di spina schuko e connettore modulare.
Light string E14 or E27 for outdoor rubber cable inclusive of schuko plug and modular connector.



colour |

colour |

I-PICNIC-E27-BCO
8031414043064



I-PICNIC-E27
8031414862719



Lampadina non inclusa / Light bulb not included

10 x E27 MAX 25W

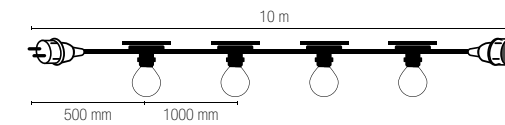

I-PICNIC-E14-BCO
8031414023745



I-PICNIC-E14
8031414862726



Lampadina non inclusa / Light bulb not included

10 x E14 MAX 25W

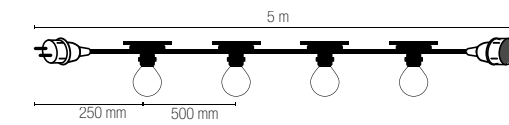

END-TO-END
easy connection / max 1000W

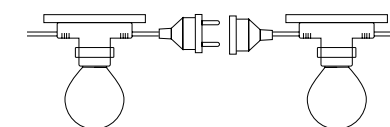

END-TO-END
easy connection / max 1000W

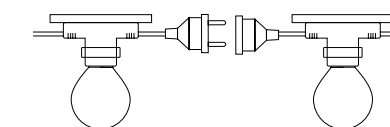

PICNIC COLOR

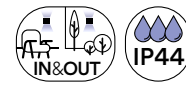

technical information **PICNIC COLOR**



Stringa elettrificata E12 per esterno con cavo in PVC inclusiva di spina schuko e connettore modulare.
Light string E12 PVC cable inclusive of schuko plug and modular connector.

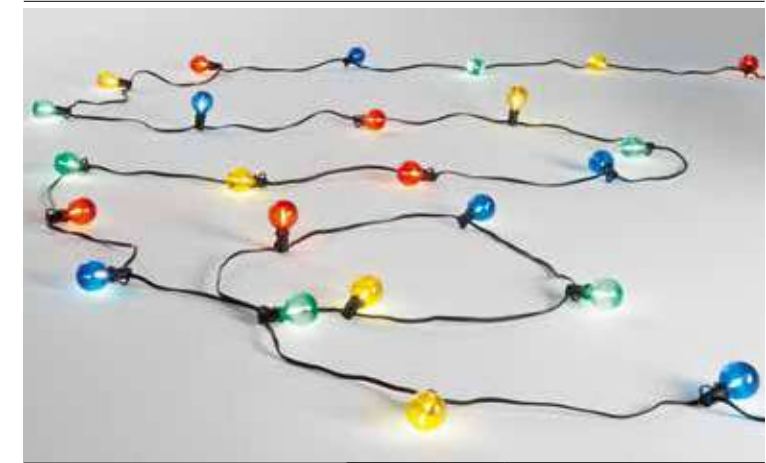

colour

Accessori inclusi /
Included accessories

I-PICNIC-COLOR
8031414891863



25 x E12 MAX 20W



Lampadina E12
E12 light bulb

7 rosse/red
6 gialle/yellow
6 verdi/green
6 blu/blue

watt 0,3W
volt 230V

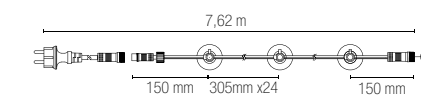

END-TO-END

easy connection / max 1000W

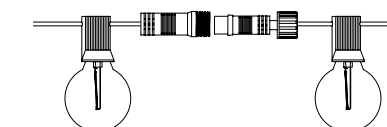

OUTDOOR

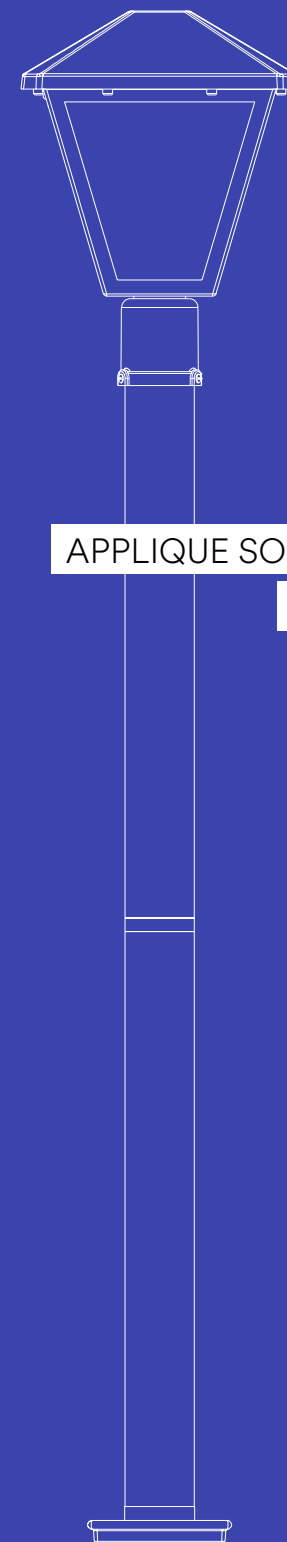

APPLIQUE SOSPENSIONI E PALETTI CORRELATI

WALL SUSPENSION AND FLOOR LAMPS COMBINED



POLLY

Collezione con base in fibre di plastica e sfere in PMMA nei colori trasparente, bianco o fumè.
Collection with base in plastic fibers and spheres in PMMA in transparent, white or smoked colors.



technical information POLLY



	colour
I-POLLY-S-TR 8031414889228	
I-POLLY-S-BCO 8031414889204	
I-POLLY-S-GR 8031414889211	

1 x E27 MAX 20W

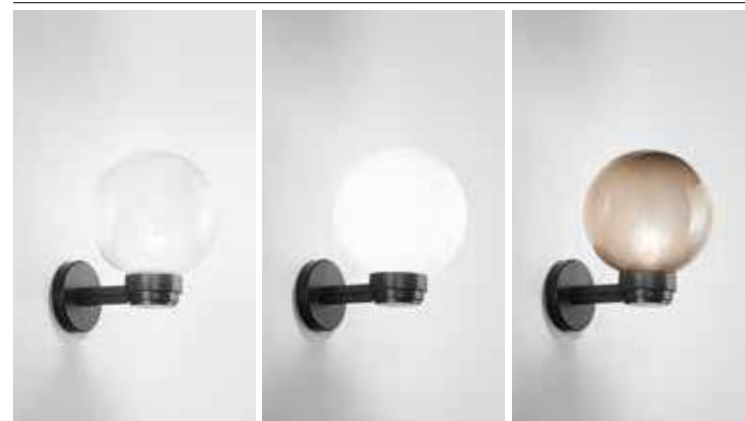
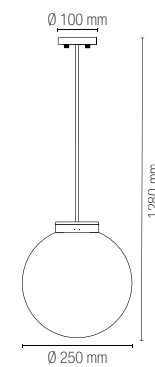

	colour
I-POLLY-AP-TR 8031414889105	
I-POLLY-AP-BCO 8031414889389	
I-POLLY-AP-GR 8031414889099	

1 x E27 MAX 20W

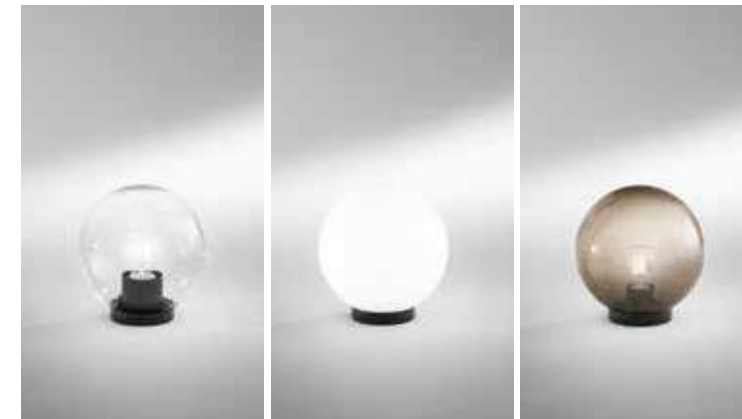
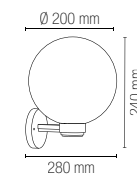

	colour
I-POLLY-G20-TR 8031414889136	
I-POLLY-G20-BCO 8031414889112	
I-POLLY-G20-GR 8031414889129	

1 x E27 MAX 20W

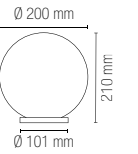

	colour
I-POLLY-G25-TR 8031414889167	
I-POLLY-G25-BCO 8031414889143	
I-POLLY-G25-GR 8031414889150	

1 x E27 MAX 20W

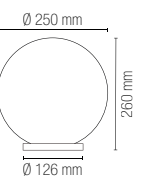

	colour
I-POLLY-G30-TR 8031414889198	
I-POLLY-G30-BCO 8031414889174	
I-POLLY-G30-GR 8031414889181	

1 x E27 MAX 20W

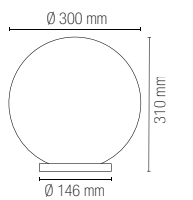

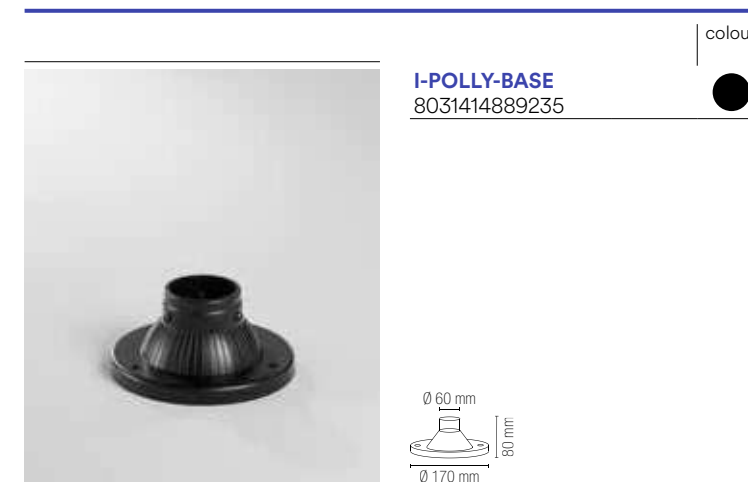
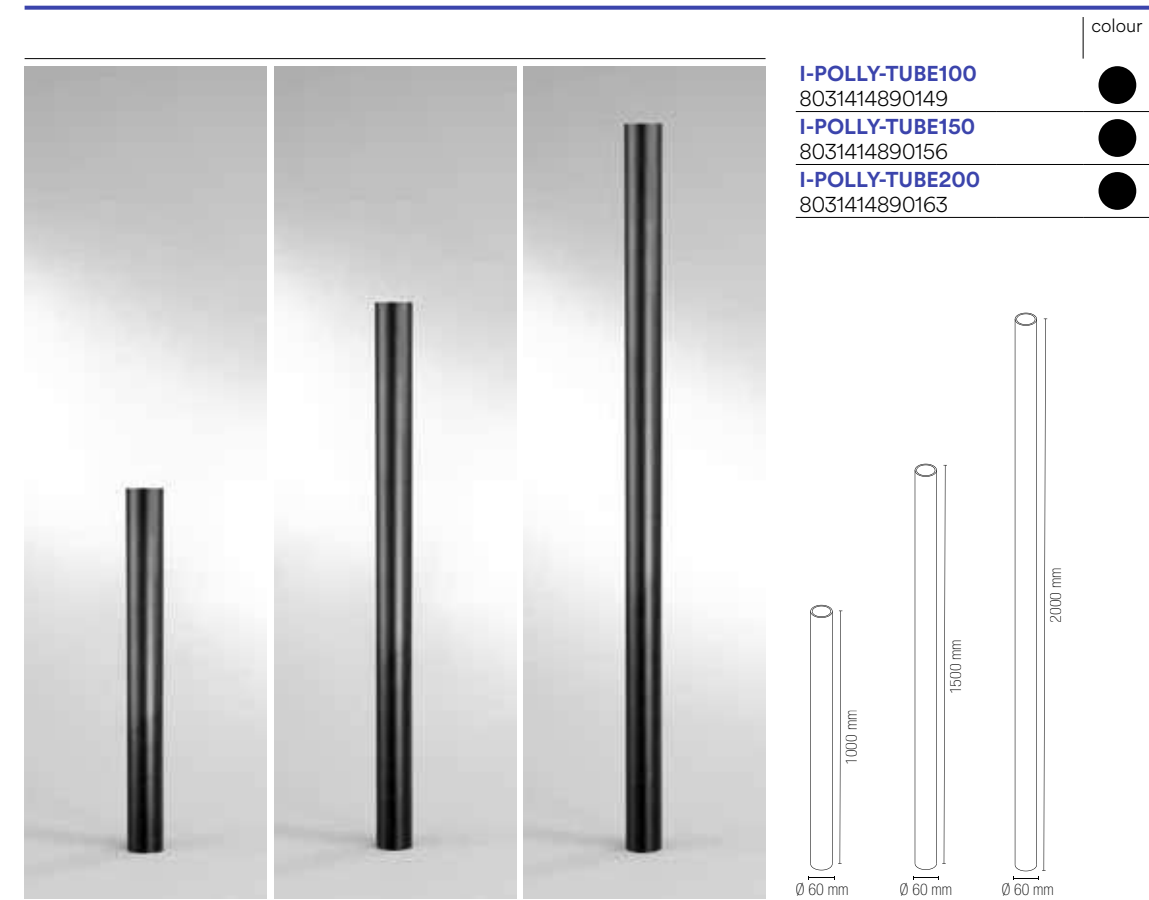

WIZARD

Collezione in alluminio antracite, LED integrato RGB+CCT con funzione smart Wi-Fi, compatibili con dispositivi VOICE CONTROL.

Aluminum collection anthracite colour built-in LED RGB+CCT with smart Wi-Fi function, compatible with VOICE CONTROL devices.

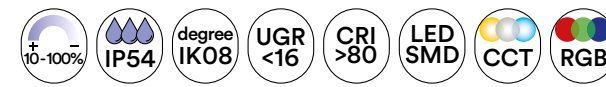

technical information

WIZARD

WI-FI
SMART INTEC



Materiale
alluminio + PC

Colore
antracite

Temperatura colore
RGB + CCT



Driver
integrato

Material
aluminum + PC

Colour
anthracite

Colour temperature
RGB + CCT



Driver
built-in



LED-WIZARD-AP

8031414870172
lumen

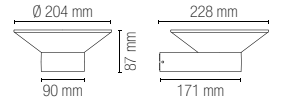
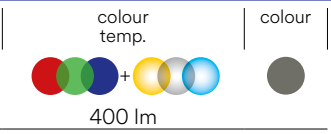

watt 10W
beam angle 110°



LED-WIZARD-P80

8031414870189
lumen

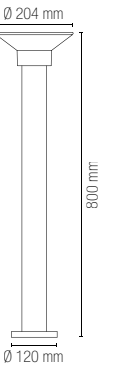
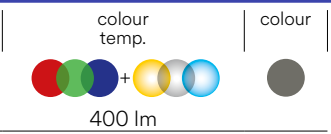

watt 10W
beam angle 110°

Control system easy installation



WAMI

Collezione a LED integrato in alluminio pressofuso nei colori antracite o corten gofrato con temperatura colore selezionabile.

Integrated LED collection in die-cast aluminum in anthracite or corten embossed colors with selectable color temperature.

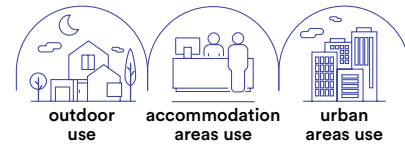

technical information **WAMI**



- Materiale**
alluminio
- Colore**
gofrato antracite
gofrato corten
- Temperatura colore selezionabile**
3000K / 4000K
- Driver**
integrato
- Material**
aluminum
- Colour**
embossed anthracite
embossed corten
- Selectable color temperature**
3000K / 4000K
- Driver**
built-in



	colour temp.	colour
LED-WAMI-AP-ANT 8031414890026		
lumen	1530 lm	
LED-WAMI-AP-BRO 8031414890057		
lumen	1530 lm	
watt	10W	
beam angle	120°	

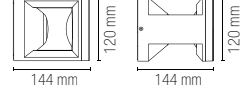

	colour temp.	colour
LED-WAMI-P25-ANT 8031414890033		
lumen	1530 lm	
LED-WAMI-P25-BRO 8031414890064		
lumen	1530 lm	
watt	12W	
beam angle	120°	

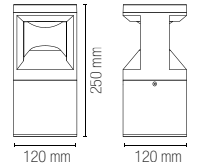

	colour temp.	colour
LED-WAMI-P80-ANT 8031414890040		
lumen	1530 lm	
LED-WAMI-P80-BRO 8031414890071		
lumen	1530 lm	
watt	12W	
beam angle	120°	

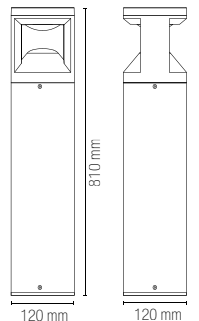

DISCOVERY

Collezione a LED integrato in alluminio con finitura antracite goffrato.
Aluminum collection LED lamp anthracite embossed finish.



collection **DISCOVERY**





- Materiale**
alluminio
- Colore**
goffrato antracite
- Temperatura colore**
4000K
- Driver**
integrato
- Material**
aluminum
- Colour**
embossed anthracite
- Colour temperature**
4000K
- Driver**
built-in



	colour temp.	colour
LED-DISCOVERY-AP 8031414877836	<input type="radio"/>	<input type="radio"/>
lumen	1440 lm	
watt	13W	
beam angle	360°	

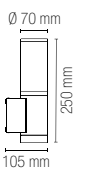

	colour temp.	colour
LED-DISCOVERY-P65 8031414877850	<input type="radio"/>	<input type="radio"/>
lumen	1440 lm	
watt	13W	
beam angle	360°	



	colour temp.	colour
LED-DISCOVERY-HUB 8031414877867	<input type="radio"/>	<input type="radio"/>
lumen	1440 lm	
watt	13W	
beam angle	360°	
	Plug 2X max 15A 250V 2500W	

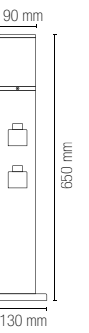

IDEM

Lampada in alluminio a LED integrato finitura antracite goffrato.
Aluminum collection anthracite colour built-in LED.



technical information **IDEM**



- Materiale**
alluminio
- Colore**
goffrato antracite
- Temperatura colore**
4000K
- Driver**
integrato
- Material**
aluminum
- Colour**
embossed anthracite
- Colour temperature**
4000K
- Driver**
built-in

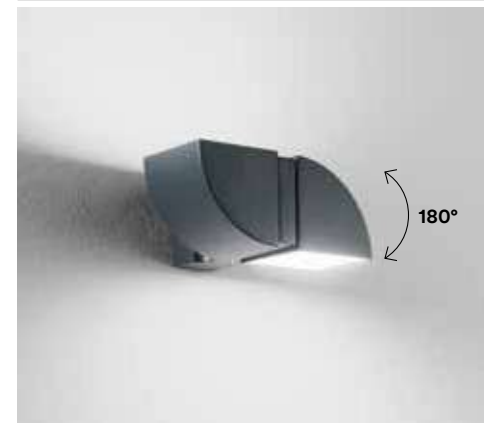

LED-IDEM-AP
8031414883103
lumen

colour temp.	colour
840 lm	

watt	8W
beam angle	120°

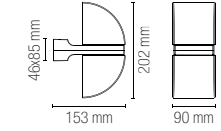

LED-IDEM-P1
8031414883110
lumen

colour temp.	colour
840 lm	

watt	8W
beam angle	120°

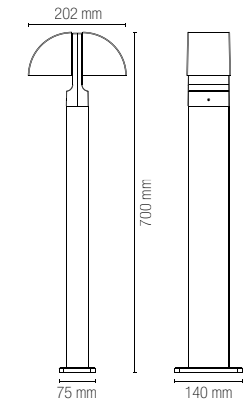

REVERSE

Lampada in alluminio a LED integrato finitura antracite goffrato.
Aluminum collection anthracite colour built-in LED.

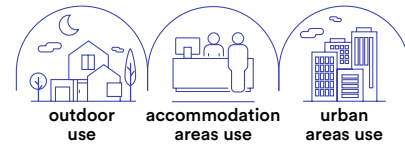

technical information **REVERSE**



- Materiale**
alluminio
- Colore**
goffrato antracite
- Temperatura colore**
4000K
- Driver**
integrato
- Material**
aluminum
- Colour**
embossed anthracite
- Colour temperature**
4000K
- Driver**
built-in

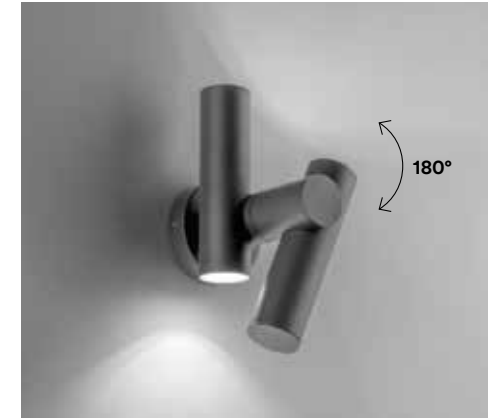
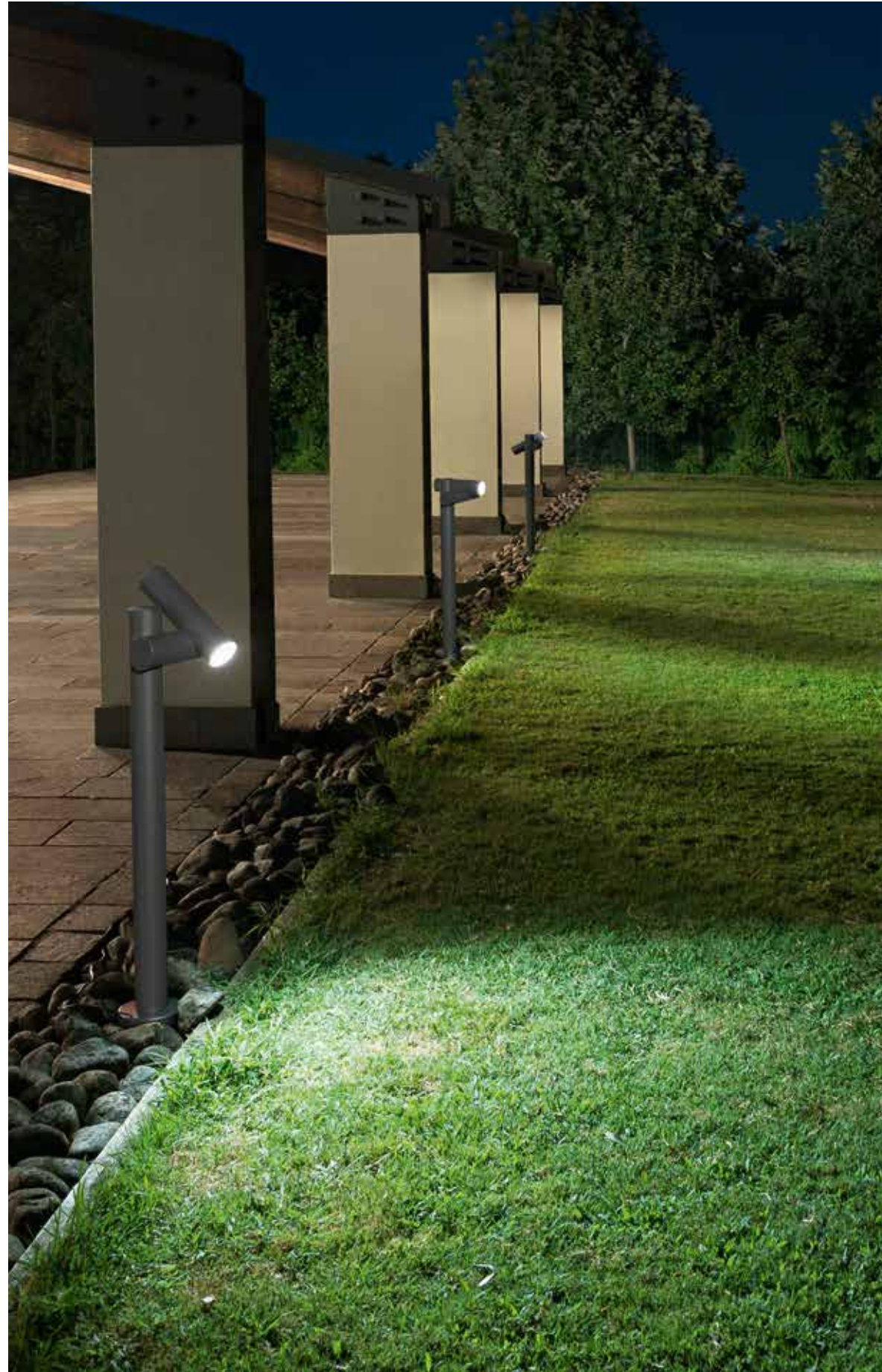

	colour temp.	colour
	620 lm	
watt	7,5W	
beam angle	120°	

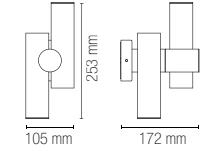

	colour temp.	colour
	460 lm	
watt	5,3W	
beam angle	120°	

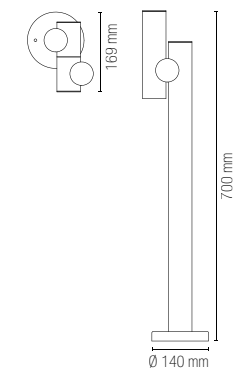

SINTESI

Lampada in alluminio a LED integrato con finitura bianco o nero goffrato.
Built in aluminum LED lamp white or black embossed finish.



technical information **SINTESI**



- Materiale**
alluminio
- Colore**
goffrato bianco
goffrato nero
- Temperatura colore**
4000K
- Driver**
integrato
- Material**
aluminum
- Colour**
embossed white
embossed black
- Colour temperature**
4000K
- Driver**
built-in



	colour temp.	colour
LED-SINTESI-AP BCO 8031414862207	●	●
lumen	400 lm	
LED-SINTESI-AP NERO 8031414862221	●	●
lumen	400 lm	
watt	6W	
beam angle	100°	



	colour temp.	colour
LED-SINTESI-P BCO 8031414862245	●	●
lumen	400 lm	
LED-SINTESI-P NERO 8031414862252	●	●
lumen	400 lm	
watt	6W	
beam angle	100°	

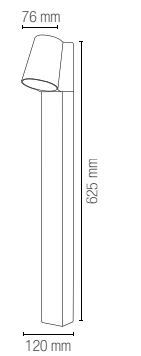

In.tec light **OUTDOOR** APPLIQUE SCSPENSIONI E PALETTI CORRELATI / WALL SUSPENSION AND FLOOR LAMPS COMBINED

ALYSON

Lampada in alluminio pressofuso a LED integrato nei colori nero o bianco gofrato con diffusore il policarbonato.
Built in aluminum LED lamp white or black embossed finish with PC diffuser.



technical information **ALYSON**



Materiale
alluminio

Colore
gofrato bianco
gofrato nero



Temperatura colore
4000K



Driver
integrato

Material
aluminum

Colour
embossed white
embossed black



Colour temperature
4000K



Driver
built-in



	colour temp.	colour
LANT-ALYSON/AP BCO 8031440361514	●	●
lumen	1300 lm	
LANT-ALYSON/AP 8031440361552	●	●
lumen	1300 lm	
watt		12W
beam angle		120°

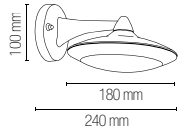

	colour temp.	colour
LANT-ALYSON/P1 BCO 8031440361538	●	●
lumen	1300 lm	
LANT-ALYSON/P1 8031440361569	●	●
lumen	1300 lm	
watt		12W
beam angle		120°

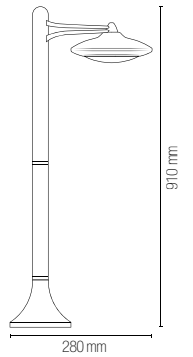

BITT

Lampada in alluminio a LED integrato finitura antracite e corten goffrato.
Aluminum collection anthracite and corten colour built-in LED.



technical information **BITT**



- Materiale**
alluminio
- Colore**
goffrato antracite
goffrato corten
- Temperatura colore**
4000K
- Temperatura colore selezionabile**
3000K / 4000K
- Driver**
integrato
- Material**
aluminum
- Colour**
embossed anthracite
embossed corten
- Colour temperature**
4000K
- Selectable color temperature**
3000K / 4000K
- Driver**
built-in



	colour temp.	colour
LED-BITT-P28-ANT 8031414883011 lumen		
LED-BITT-P28-BRO 8031414883028 lumen		
watt	10W	
beam angle	120°	

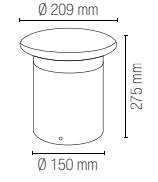

	colour temp.	colour
LED-BITT-P76-ANT 8031414883035 lumen		
LED-BITT-P76-BRO 8031414883042 lumen		
watt	10W	
beam angle	120°	

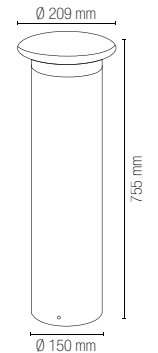

In.tec light **OUTDOOR** APPLIQUE SCOSPENSIONI E PALETTI CORRELATI / WALL SUSPENSION AND FLOOR LAMPS COMBINED

NISMO

Collezione in alluminio a LED integrato finitura bianco goffrato.
Aluminum collection LED lamp white embossed finish.

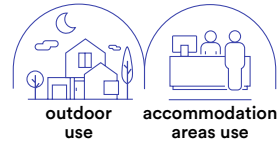

outdoor use accommodation areas use

Materiale
alluminio

Colore
goffrato bianco

Temperatura colore
4000K

Temperatura colore selezionabile
3000K / 4000K



Driver
integrato

Material
aluminum

Colour
embossed white

Colour temperature
4000K

Selectable color temperature
3000K / 4000K



Driver
built-in

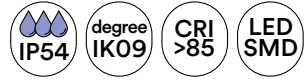

LED-NISMO-AP
8031440361224
lumen

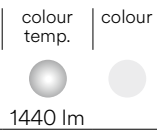

watt 12W
beam angle 120°

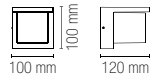

LED-NISMO-P60
8031440361231
lumen

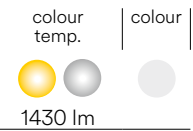

watt 12W
beam angle 120°

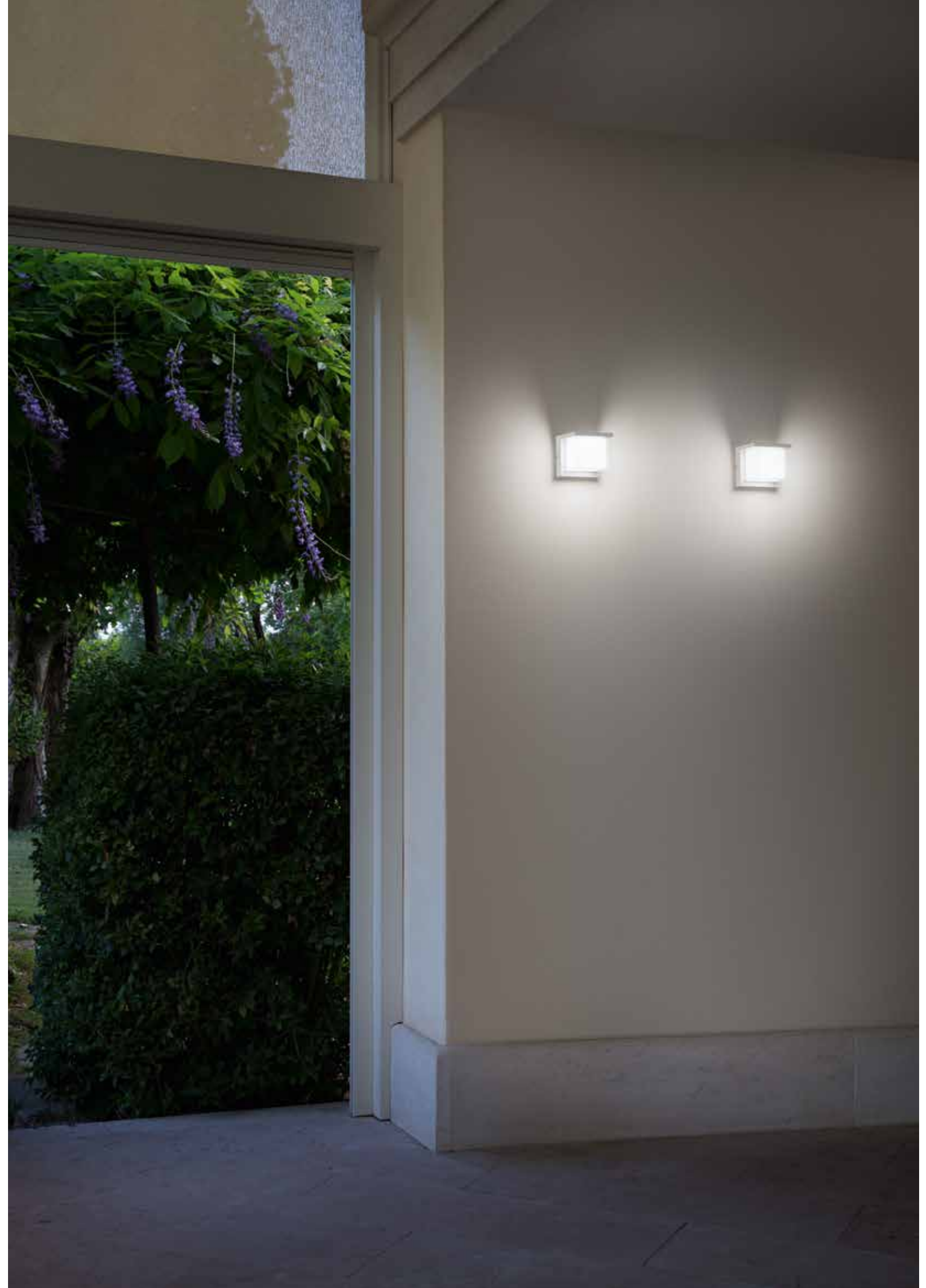



STATION

Collezione in acciaio finitura antracite.
 Diffusore in policarbonato bianco.
 Stainless steel collection anthracite finish.
 White PC diffuser.

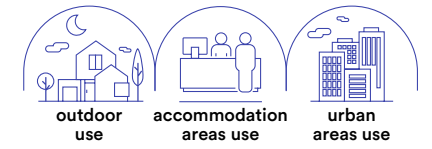

colour ●

I-STATION-E27-SC2
 8031414879571

1 x E27 MAX 60W



Plug 2X max 15A 250V 2500W

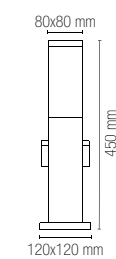

colour ●

I-STATION-SC2
 8031414879564



Plug 2X max 15A 250V 2500W

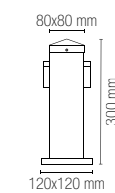

Lampadina non inclusa /
 Light bulb not included

UNDERWOOD

Collezione in metallo finitura antracite o corten.
Metal collection anthracite or corten finish.

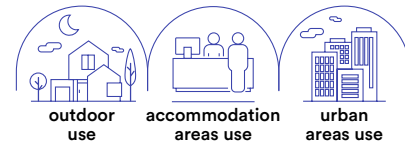

technical information **UNDERWOOD**

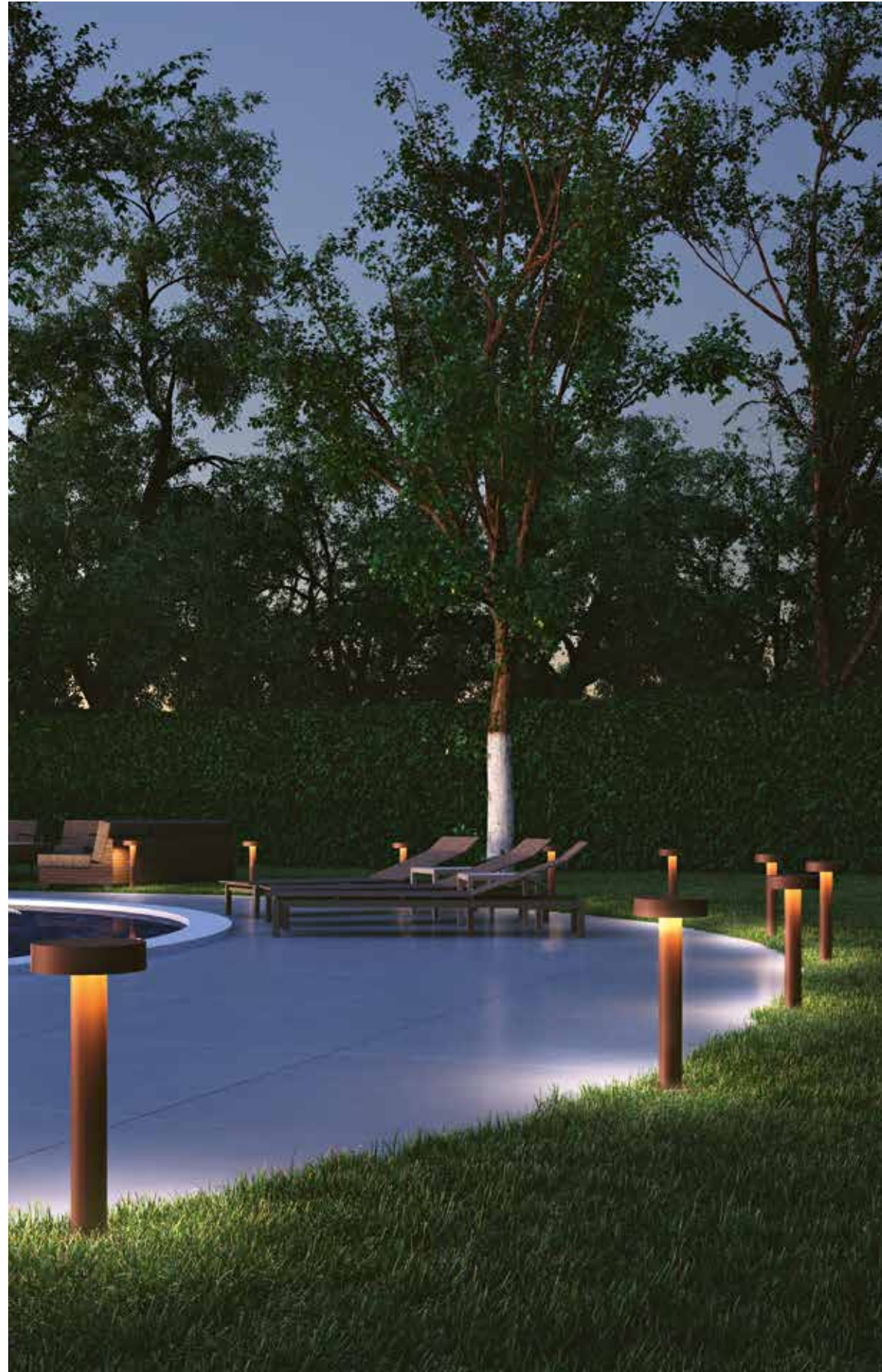

	colour
I-UNDERWOOD-P70-ANT 8031414883059	
I-UNDERWOOD-P70-BRO 8031414883066	
4 x G9 LED	10W



Lampadina non inclusa /
Light bulb not included

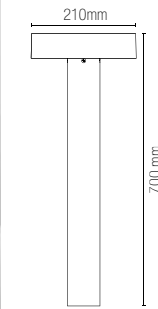

In.tec light **OUTDOOR** APPLIQUE SCSPENSIONI E PALETTI CORRELATI / WALL SUSPENSION AND FLOOR LAMPS COMBINED

TOKYO

Collezione in acciaio inox con diffusore in policarbonato.
Finiture bianco, bronzo, nikel spazzolato e grigio antracite.
Stainless steel collection with polycarbonate diffuser.
White, bronze, brushed nickel and anthracite grey finishes.

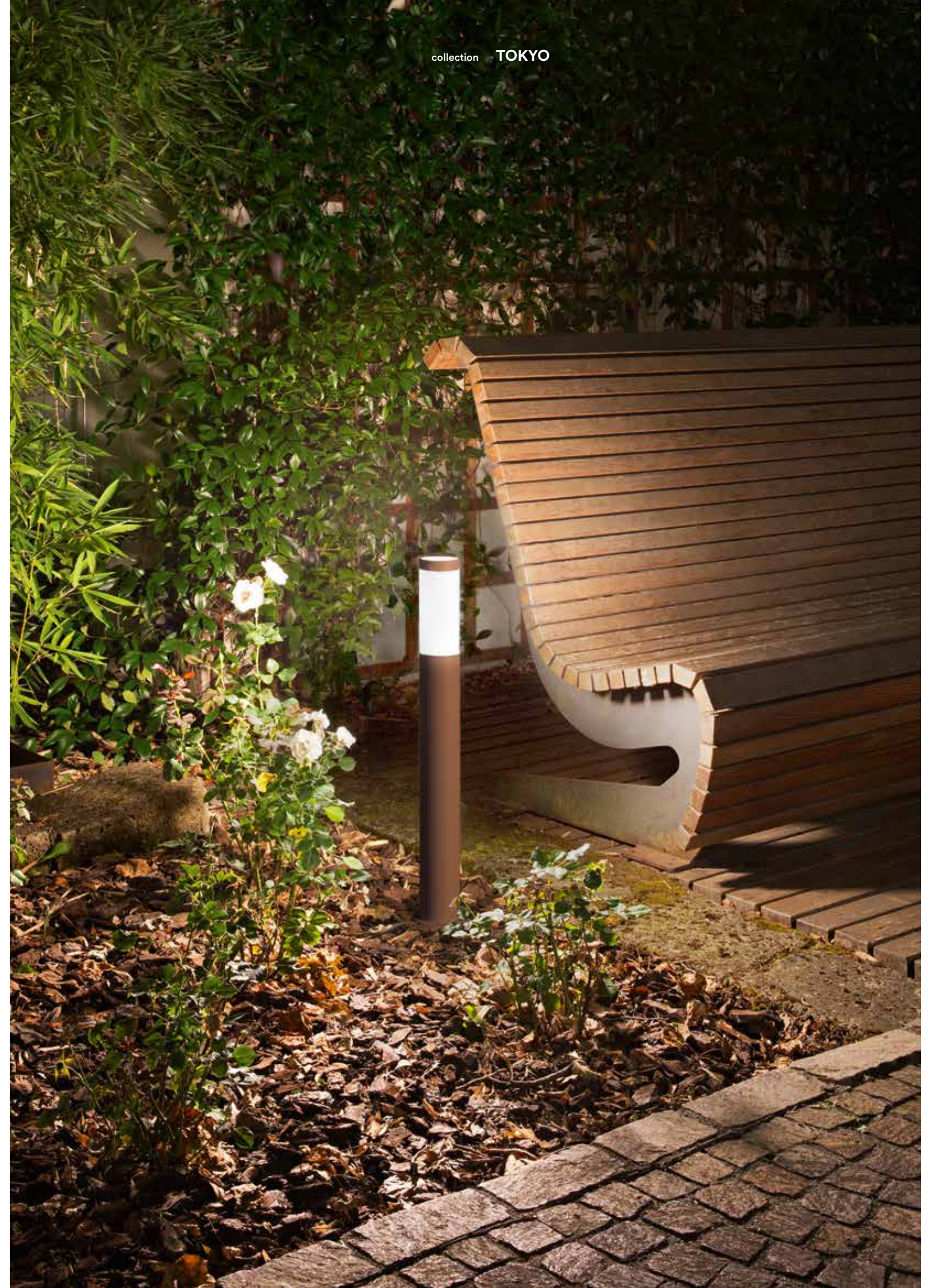
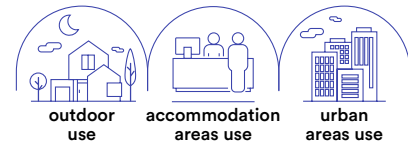

collection TOKYO

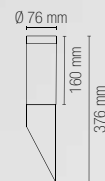

- | | |
|--|---|
| I-TOKYO-AP BCO
8031414864447 | ● |
| I-TOKYO-AP ANT
8031414888795 | ● |
| I-ST021
8031421451081 | ● |
| I-TOKYO-AP BRO
8031414864423 | ● |

colour

- | | |
|--|---|
| | Lampadina consigliata / Suggested light bulb |
| | Lampadina non inclusa / Light bulb not included |

1 x E27 MAX 40W

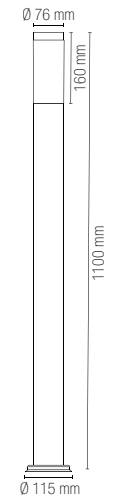

- | | |
|---------------------------------------|---|
| I-TOKYO-P BCO
8031414864416 | ● |
| I-TOKYO-P ANT
8031414888801 | ● |
| I-ST022-1100
8031421661084 | ● |
| I-TOKYO-P BRO
8031414864393 | ● |

colour

- | | |
|--|---|
| | Lampadina consigliata / Suggested light bulb |
| | Lampadina non inclusa / Light bulb not included |

1 x E27 MAX 40W

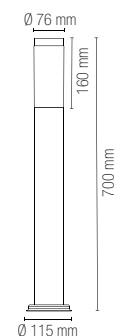

- | | |
|---|---|
| I-TOKYO-P70 BCO
8031414875320 | ● |
| I-TOKYO-P70 ANT
8031414888818 | ● |
| I-ST022-700
8031414877225 | ● |
| I-TOKYO-P70 BRO
8031414871780 | ● |

colour

- | | |
|--|---|
| | Lampadina consigliata / Suggested light bulb |
| | Lampadina non inclusa / Light bulb not included |

1 x E27 MAX 40W

DROP

Collezione in alluminio finitura antracite con diffusore in policarbonato.
Aluminum collection anthracite finish with PC diffuser.



technical information **DROP**



I-DROP-P33-ANT
8031414883073

colour

1 x G9 LED

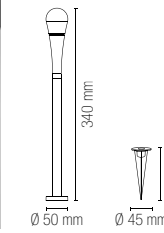

Lampadina consigliata / Suggested light bulb



Lampadina non inclusa / Light bulb not included



I-DROP-P53-ANT
8031414883080

colour

1 x G9 LED

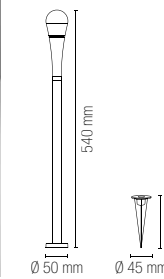

Lampadina consigliata / Suggested light bulb



Lampadina non inclusa / Light bulb not included



I-DROP-P73-ANT
8031414882793

colour

1 x G9 LED

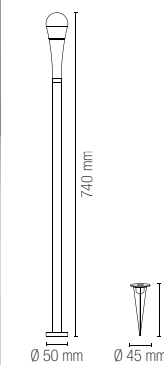

Lampadina consigliata / Suggested light bulb



Lampadina non inclusa / Light bulb not included

ETNA

Collezione in cemento grigio.
Gray concrete collection.



technical information **ETNA**



I-ETNA-AP4
8031414866762

4 x GU10 MAX 10W

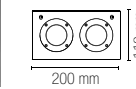
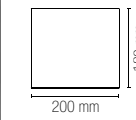

colour
●



Connettore IP65 incluso /
IP65 connector included



Lampadina non inclusa /
Light bulb not included



I-ETNA-P2
8031414867905

2 x GU10 MAX 10W

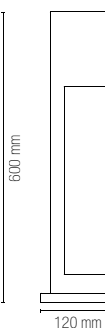
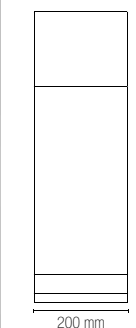

colour
●



Connettore IP65 incluso /
IP65 connector included



Lampadina non inclusa /
Light bulb not included

MASAI

Palo in cemento bianco.
Concrete post lamp white concrete colour.

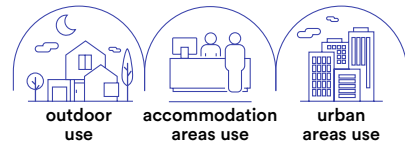

I-MASAI-P1
8031414868100

1 x R7S MAX 7W

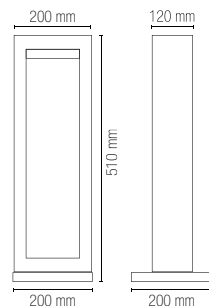

- Connettore IP65 incluso / IP65 connector included
- Lampadina non inclusa / Light bulb not included

PERRET

Collezione in cemento grigio con diffusore in acrilico.
Concrete collection gray finish with acrylic diffuser.

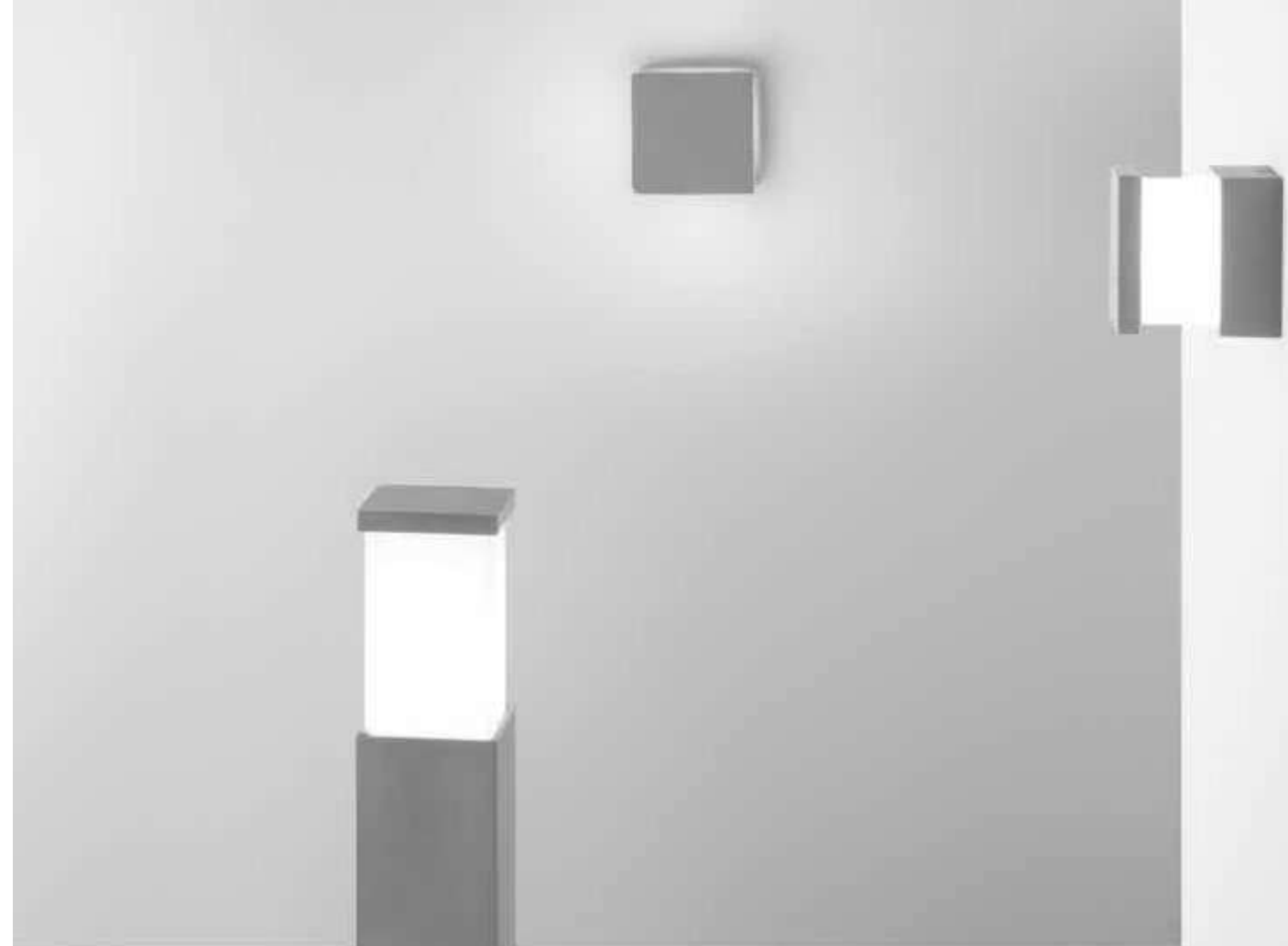

I-PERRET-AP
8031414871827

1 x E14 MAX 10W

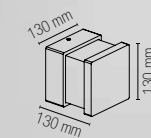

- Connettore IP65 incluso / IP65 connector included
- Lampadina non inclusa / Light bulb not included



I-PERRET-P60
8031414871834

1 x E27 MAX 15W

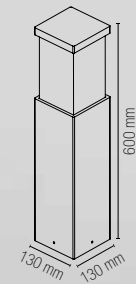

JAMMIN

Lampada da tavolo ricaricabile.
Rechargeable table lamp.



Materiale
metallo e PE

Colore
goffrato bianco
goffrato nero



Temperatura colore
3000K



Material
metal and PE

Colour
embossed white
embossed black



Colour temperature
3000K



LED-JAMMIN-L-BCO
8031414884377
lumen

colour temp.	colour
60 lm - 9h	

LED-JAMMIN-L-NER
8031414884384
lumen

60 lm - 9h	

watt 2,2W

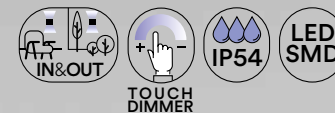
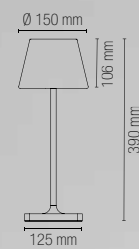

Accessori inclusi /
Included accessories

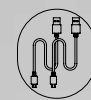

USB A 5V 2A
USB C 5V 2A
Cavo per ricarica /
Charging cable



5-7
hours
DC3.7V 4000 mAh
Batteria ricaricabile
non sostituibile /
Rechargeable battery
non replaceable



BRIO

Lampada da tavolo ricaricabile.
Rechargeable table lamp.



collection **BRIO**

Materiale
PC

Colore
bianco
nero



Temperatura colore
3000K



Material
PC

Colour
white
black



Colour temperature
3000K



LED-BRIO-BCO
8031414889594
lumen

colour temp.	colour
200 lm	

LED-BRIO-NER
8031414889587
lumen

200 lm	

watt

3,5W

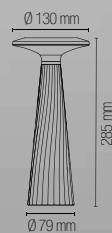

Accessori inclusi /
Included accessories



USB
Cavo per ricarica /
Charging cable



DC3.7V 1200 mAh
Batteria ricaricabile
non sostituibile /
Rechargeable battery
non replaceable



DRINK

Lampada da tavolo ricaricabile.
Rechargeable table lamp.



Materiale
metallo

Colore
goffrato bianco
goffrato nero
goffrato oro
goffrato corten



Temperatura colore
3000K



Material
metal

Colour
embossed white
embossed black
embossed gold
embossed corten



Colour temperature
3000K



LED-DRINK-BCO 8031414885299	colour temp.	colour
lumen	190 lm - 9h	
LED-DRINK-NER 8031414885312		
lumen	190 lm - 9h	
LED-DRINK-ORO 8031414885329		
lumen	190 lm - 9h	
LED-DRINK-BRO 8031414885305		
lumen	190 lm - 9h	

watt 2,2W

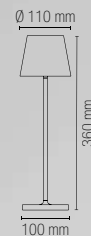

**Accessori inclusi /
Included accessories**



Base per ricarica con
USB e adattatore /
Charging base with
USB and adaptor



5-7 hours **DC3.7V 2x2200 mAh**
Batteria ricaricabile non sostituibile /
Rechargeable battery non replaceable



COCKTAIL

Lampada da tavolo ricaricabile.
Rechargeable table lamp.



Materiale
metallo

Colore
goffrato bianco
goffrato nero
goffrato oro
goffrato corten



Temperatura colore
3000K



Material
metal

Colour
embossed white
embossed black
embossed gold
embossed corten



Colour temperature
3000K



LED-COCKTAIL-BCO 8031414882496	colour temp.	colour
lumen	192 lm - 9h	
LED-COCKTAIL-NER 8031414882502		
lumen	192 lm - 9h	
LED-COCKTAIL-ORO 8031414885282		
lumen	192 lm - 9h	
LED-COCKTAIL-BRO 8031414882519		
lumen	192 lm - 9h	

watt 2,2W



**Accessori inclusi /
Included accessories**



Cavo per ricarica con
adattatore DC5V 1A 1,2 m /
Charging cable with
adaptor DC5V 1A 1,2 m



5-7 hours **DC3.7V 2x2200 mAh**
Batteria ricaricabile non sostituibile /
Rechargeable battery non replaceable

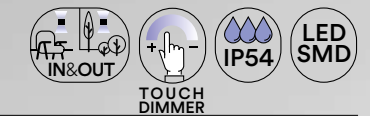



CLIMAX

Lanterna ricaricabile.
Rechargeable lamp.



collection **CLIMAX**

Materiale
metallo - acrilico

Colore
nero opaco



Temperatura colore
3000K



Material
metal - acrylic

Colour
matt black



Colour temperature
3000K



LED-CLIMAX-L1
8031414883141
lumen

colour temp.
140 lm - 8h

watt 2W

LED-CLIMAX-LG1
8031414883158
lumen

colour temp.
140 lm - 8h

watt 2W

Accessori inclusi / Included accessories



USB
Cavo per ricarica /
Charging cable



5-7 hours
DC3.7V 2600 mAh
Batteria ricaricabile
non sostituibile /
Rechargeable battery
non replaceable

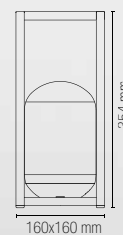
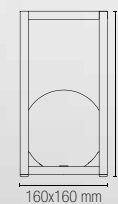



OBERON

Lanterna ricaricabile.
Rechargeable lamp.



Materiale
metallo

Colore
bianco

Temperatura colore
3000K

Material
metal

Colour
white

Colour temperature
3000K

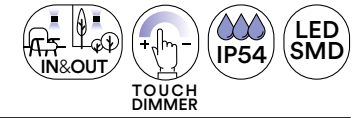

LANT-OBERON
8031414882526
lumen

colour temp. 3000K
colour white
168 lm - 9h

watt

2,2W

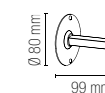
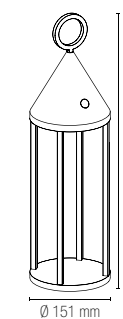

LANT-OBERON-KIT-AP
8031414882533

Kit staffa applique per lume /
Wall lamp bracket kit

LANT-OBERON-KIT-S
8031414882540

Kit sospensione per lume cavo 2 m /
Suspension kit 2 m cable

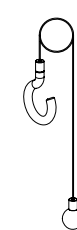

Accessori inclusi / Included accessories

Cavo per ricarica con adattatore DC5V 1A 1,2 m / Charging cable with adaptor DC5V 1A 1,2 m

6 hours DC3.7V 2x2200 mAh
Batteria ricaricabile non sostituibile / Rechargeable battery non replaceable

GECO DJ

Lampada portatile LED RGBW in polietilene con speaker bluetooth incorporato.
LED portable RGBW lamp with speaker bluetooth included polyethylene material.



collection **GECO**

Materiale

PE

Temperatura colore

RGB + 4000K



Driver

incluso

Material

PE

Colour temperature

RGB + 4000K



Driver

included



I-GECO-DJ-L25

8031414862542

lumen

watt

colour temp.
RGB + 180 lm - 8h



3W

Accessori inclusi / Included accessories



Cavo per ricarica con adattatore DC5V 1A 1,2 m / Charging cable with adaptor DC5V 1A 1,2 m 230V 50Hz



Telecomando infrarossi / IR remote control



Speaker 10W Bluetooth 4.0, distanza connessione max 15 m, durata 2h / 10w speaker bluetooth 4.0 connection distance max 15 m, lasting time 2h



Batteria ricaricabile non sostituibile / Rechargeable battery non replaceable

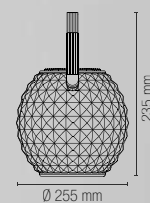

GECO LED

Vaso e lampada LED RGBW in polietilene.
Vase and RGBW LED lamp in polyethylene.



technical information **GECO LED**



Materiale

PE

Temperatura colore

RGB + 4000K



Driver

incluso

Material

PE

Colour temperature

RGB + 4000K



Driver

included



Accessori inclusi / Included accessories



Cavo per ricarica con adattatore DC5V 1A 1,2 m / Charging cable with adaptor DC5V 1A 1,2 m 230V 50Hz



Telecomando infrarossi / IR remote control



Batteria ricaricabile non sostituibile / Rechargeable battery non replaceable

I-GECO-VASO-Q-L

8031414862535

lumen



RGB 240 lm - 8h

I-GECO-VASO-Q-XL

8031414864713

lumen



RGB 240 lm - 8h

watt

4W

I-GECO-VASO-R-L

8031414862528

lumen

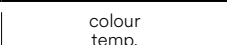

RGB 240 lm - 8h

I-GECO-VASO-R-XL

8031414864720

lumen



RGB 240 lm - 8h

watt

4W

I-GECO-SFERA-L30

8031414862436

lumen

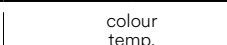

RGB 240 lm - 8h

I-GECO-SFERA-L40

8031414862443

lumen



RGB 240 lm - 8h

I-GECO-SFERA-L50

8031414862450

lumen



RGB 240 lm - 8h

watt

4W

I-GECO-CUBO-L30

8031414862467

lumen

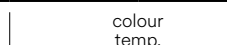

RGB 240 lm - 8h

I-GECO-CUBO-L40

8031414862474

lumen



RGB 240 lm - 8h

I-GECO-CUBO-L50

8031414862481

lumen



RGB 240 lm - 8h

watt

4W

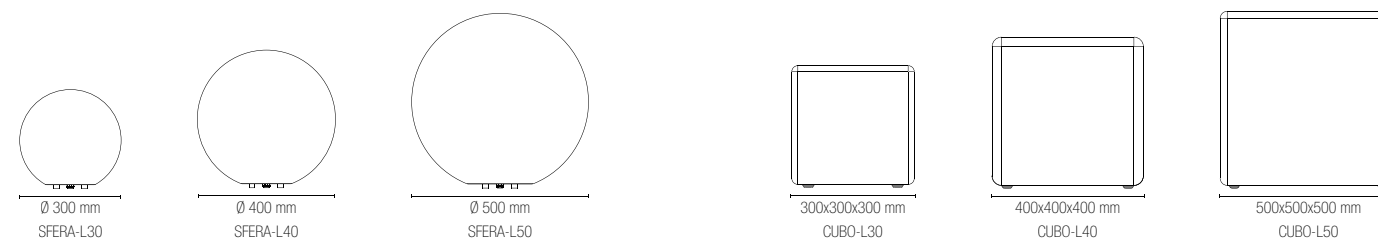
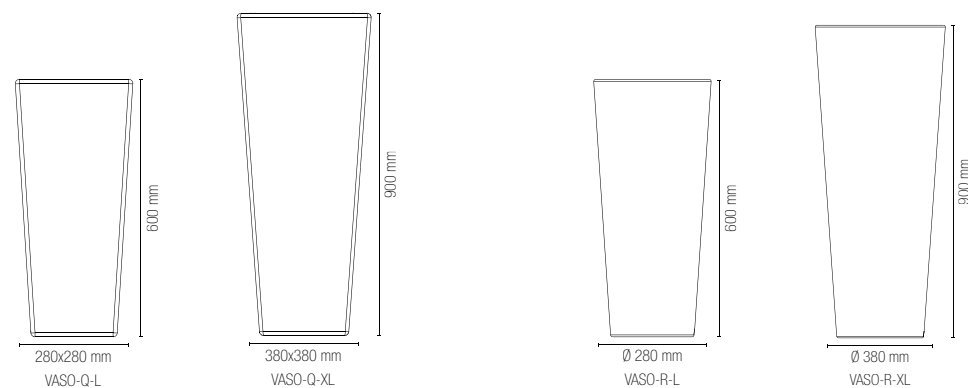

GECO E27

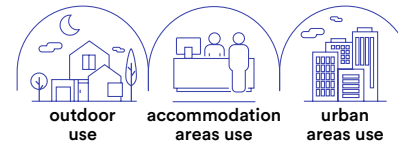

Lampadine LED Intec consigliate per illuminazione multicolor o bianco dinamico presenti nel catalogo BULBS COLLECTION / Suggested LED Intec bulbs for multicolor or dynamic white lighting included in the catalogue BULBS COLLECTION

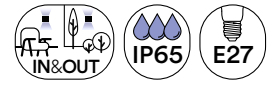

Lampada LED SMART / LED SMART bulb

colour temp.

SMART-E27-RGBCCT
8031414872657



watt

10W



Control system easy installation



Lampada LED RGBW classe F / LED RGBW bulb class F

colour temp.

I-LUMYA-E27-RGB
8031440354431



watt

10W



IR Control system

GECO E27

Collezione di lampade con attacco E27 in polietilene.
PE lamp with E27 lampholder.

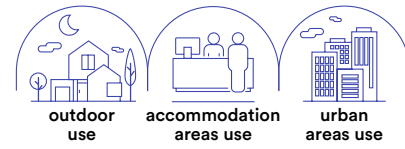

collection **GECO E27**



I-GECO-SFERA-S30
8031414864461

1 x E27 MAX 42W

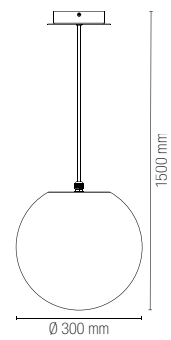

I-GECO-SFERA-S40
8031414864454

1 x E27 MAX 42W

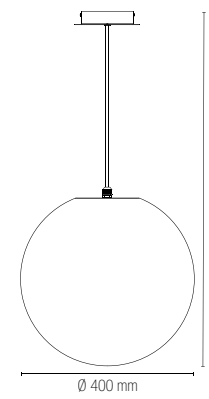

Lampadina non inclusa /
Light bulb not included



Accessori inclusi / Included accessories

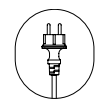

Cavo 2,5 m con spina shuko / 2,5 m of cable with schuko plug



I-GECO-VASO-E-Q-L
8031414868506
I-GECO-VASO-E-Q-XL
8031414868131

1 x E27 MAX 42W

I-GECO-VASO-E-R-L
8031414868513
I-GECO-VASO-E-R-XL
8031414868520

1 x E27 MAX 42W

I-GECO-SFERA-E-L30
8031414868476
I-GECO-SFERA-E-L40
8031414868483
I-GECO-SFERA-E-L50
8031414868490

1 x E27 MAX 42W

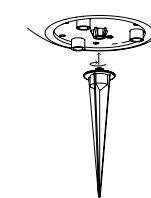

I-GECO-SPK
8031414878437

Picchetto alluminio per lampade GECO E27 / Aluminum spike for E27 GECO family

I-GECO-CUBO-E-L30
8031414867943
I-GECO-CUBO-E-L40
8031414868117
I-GECO-CUBO-E-L50
8031414868124

1 x E27 MAX 42W

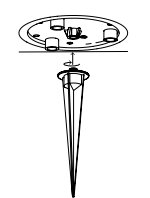

I-GECO-SPK
8031414878437

Picchetto alluminio per lampade GECO E27 / Aluminum spike for E27 GECO family

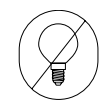

Lampadina non inclusa / Light bulb not included

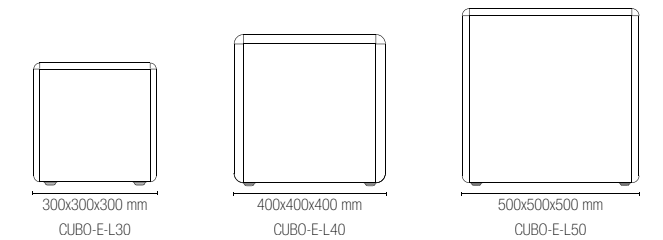
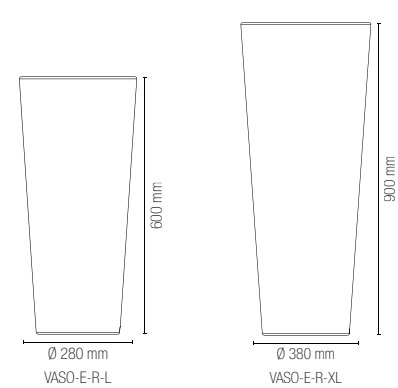
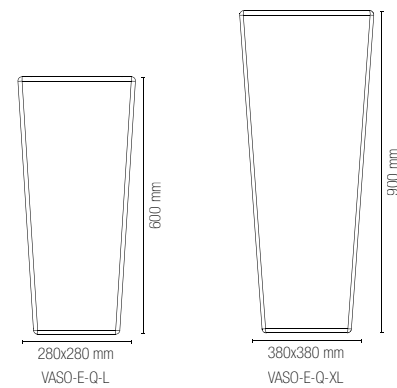

GECO E27

Piantana in polietilene con struttura in metallo bianco opaco o antracite.
PE floor lamp with metal structure white or anthracite colour.



technical information

GECO E27

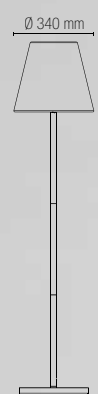



colour 

I-GECO-BAR-PT
8031414868599

1 x E27 MAX 42W

Accessori inclusi / Included accessories

 Cavo 2,5 m con spina shuko / 2,5 m of cable with schuko plug 

 Lampadina non inclusa / Light bulb not included

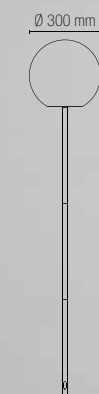



colour 

I-GECO-SFERA-PT30
8031414864430

1 x E27 MAX 42W

Accessori inclusi / Included accessories

 Cavo 2,5 m con spina shuko / 2,5 m of cable with schuko plug 

 Lampadina non inclusa / Light bulb not included



GECO LED SOLAR

Lampada portatile e galleggiante LED RGBW in polietilene con autoricarica solare.
PE LED portable and floating RGBW lamp with solar self charge.

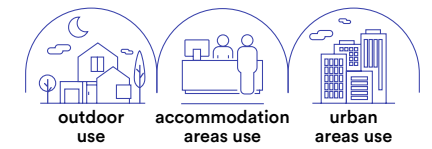

Materiale

PE

Temperatura colore

RGB + 4000K



Driver

incluso

Material

PE

Colour temperature

RGB + 4000K



Driver

included

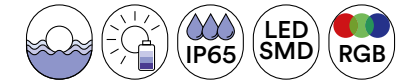

Accessori inclusi / Included accessories

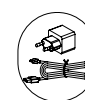

Cavo per ricarica con adattatore DC5V 1A 1,2 m / Charging cable with adaptor DC5V 1A 1,2 m 230V 50Hz

IP20



Telecomando infrarossi / IR remote control



Carica alimentatore / DC charge
Batteria ricaricabile non sostituibile / Rechargeable battery non replaceable



Carica solare / Auto solar charge
Batteria ricaricabile non sostituibile / Rechargeable battery non replaceable

	colour temp.
I-GECO-CUBO-SOL30 8031414870837 lumen	+ RGB 90 lm - 12h
I-GECO-CUBO-SOL40 8031414870844 lumen	+ RGB 90 lm - 12h

watt 1,5W

	colour temp.
I-GECO-SFERA-SOL30 8031414870868 lumen	+ RGB 90 lm - 12h
I-GECO-SFERA-SOL40 8031414870875 lumen	+ RGB 90 lm - 12h

watt 1,5W

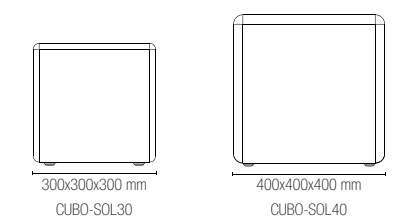
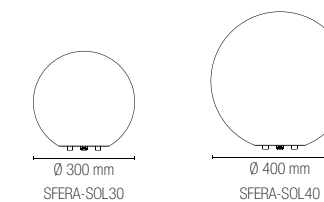



MANDALA

Collezione in metallo antracite con diffusore in vetro trasparente.
Metal collection anthracite finish with transparent glass diffuser.



Lampadina consigliata /
Suggested light bulb



Lampadina non inclusa /
Light bulb not included

LANT-MANDALA/S1
8031414870684

1 x E27 MAX 60W

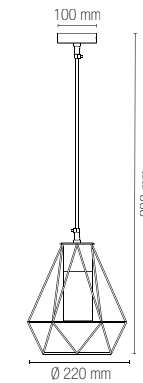

LANT-MANDALA/AP
8031414862641

1 x E27 MAX 60W

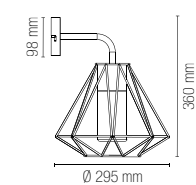



YORK

Collezione in alluminio nero con diffusore in policarbonato.
Black aluminum collection with PC diffuser.



Lampadina consigliata /
Suggested light bulb



Lampadina non inclusa /
Light bulb not included

LANT-YORK/S1
8031414862764

1 x E27 MAX 60W

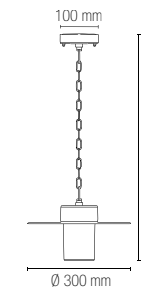

colour



LANT-YORK/AP
8031414862757

1 x E27 MAX 60W

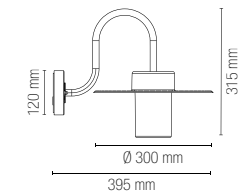

colour



MIRAGE

Lanterna in metallo colore bianco o antracite diffusore in vetro trasparente.
Metal lantern white or anthracite finish with clear glass diffuser.

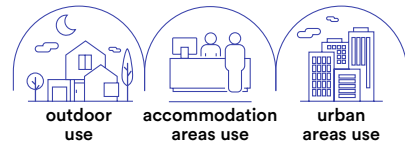

technical information **MIRAGE**



	colour
LANT-MIRAGE-AP-BCO 8031414896394	●
LANT-MIRAGE-AP 8031414867059	●
1 x E27 MAX 60W	

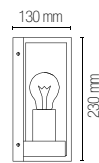

Lampadina non inclusa /
Light bulb not included



	colour
LANT-MIRAGE-S1-BCO 8031414896431	●
LANT-MIRAGE-S1 8031414867066	●
1 x E27 MAX 60W	

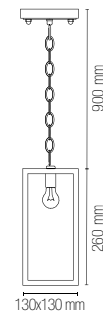

	colour
LANT-MIRAGE-L1-BCO 8031414896400	●
LANT-MIRAGE-L1 8031414869190	●
1 x E27 MAX 60W	

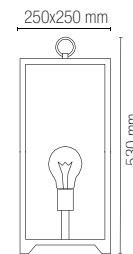

Accessori inclusi / Included accessories

Cavo 2,5 m
con spina shuko /
2,5 m of cable
with schuko plug



	colour
LANT-MIRAGE-P90-BCO 8031414896424	●
LANT-MIRAGE-P90 8031414869206	●
1 x E27 MAX 60W	

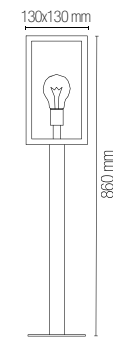

	colour
LANT-MIRAGE-P200-BCO 8031414896417	●
LANT-MIRAGE-P200 8031414869213	●
1 x E27 MAX 60W	

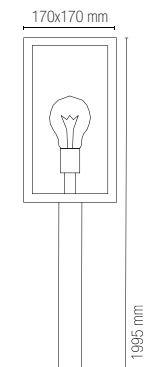

SKITTLE

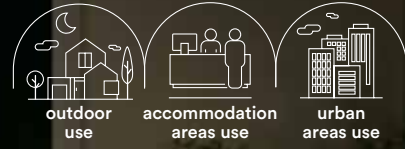

technical information **SKITTLE**



Collezione in alluminio pressofuso colore antracite con diffusore in PC.
Collection in die-cast aluminum in anthracite colour with PC diffuser.



	colour		colour		colour		colour
I-SKITTLE-AP 8031414881819	●	I-SKITTLE-PL 8031414881826	●	I-SKITTLE-P65 8031414881833	●	I-SKITTLE-P100 8031414882434	●
1 x E27 MAX 28W		1 x E27 MAX 28W		1 x E27 MAX 28W		1 x E27 MAX 28W	



Lampadina consigliata / Suggested light bulb



Lampadina non inclusa / Light bulb not included

OUTDOOR APPLIQUE SCSPENSIONI E PALETTI CORRELATI / WALL SUSPENSION AND FLOOR LAMPS COMBINED

In.tec light

ORBIT

Lantern in acrilico PMMA e base in alluminio pressofuso nero.
Acrylic PMMA lantern with base in die cast aluminum black finish.

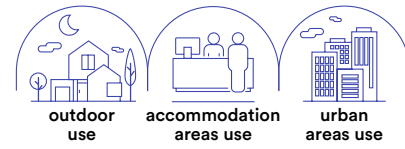

technical information **ORBIT**



LANT-ORBIT/AP
8031414862658

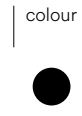

1 x E27 MAX 60W

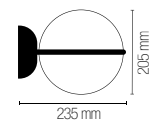

LANT-ORBIT/S1
8031414862665



1 x E27 MAX 60W

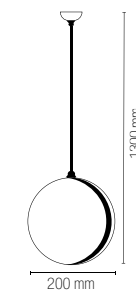

LANT-ORBIT/L1
8031414866335



1 x E27 MAX 60W

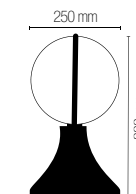

LANT-ORBIT/P1
8031414862689



1 x E27 MAX 60W

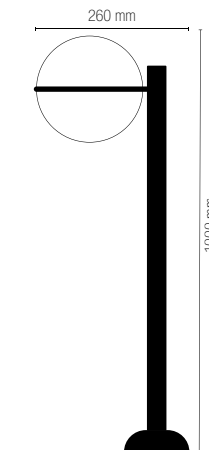

LANT-ORBIT/P3
8031414862702



3 x E27 MAX 60W

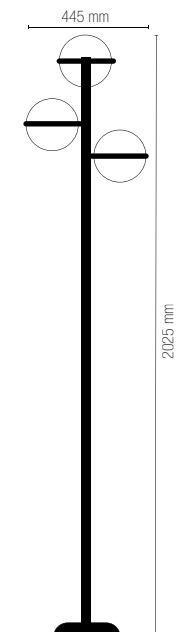

 Lampadina non inclusa /
Light bulb not included

PRISMA

Lanterna in alluminio pressofuso colore antracite diffusore in vetro trasparente.
Die cast aluminum lantern anthracite finish with clear glass diffuser.



technical information **PRISMA**



	colour		colour		colour		colour
LANT-PRISMA/APIA 8031414867103	●	LANT-PRISMA/APIB 8031414867073	●	LANT-PRISMA/S1 8031414867080	●	LANT-PRISMA/P1 8031414869183	●

1 x E27 MAX 60W 1 x E27 MAX 60W 1 x E27 MAX 60W 1 x E27 MAX 60W

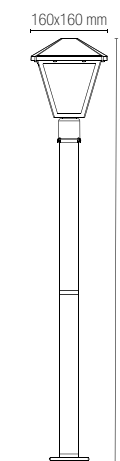
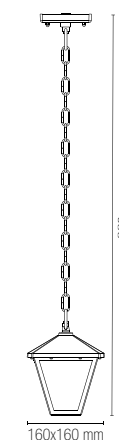
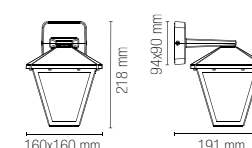
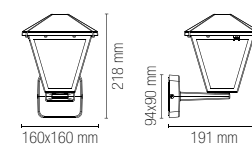

Lampadina consigliata / Suggested light bulb



Lampadina non inclusa / Light bulb not included

CLOE

Lanterna LED integrato in alluminio pressofuso
colore nero goffrato diffusore in policarbonato.

Die cast aluminum built-in LED lantern
black embossed finish with PC diffuser.



technical information **CLOE**



Materiale
alluminio pressofuso
+ policarbonato

Colore
goffrato nero

Temperatura colore
4000K

Driver
integrato

Material
die cast aluminum
+ polycarbonate

Colour
embossed black

Colour temperature
4000K

Driver
built-in

Life time and on/off
15.000h
>10.000 on/off



	colour temp.		colour temp.		colour temp.
LANT-CLOE/APIA 8031440361385	●	LANT-CLOE/APIA-S 8031440361408	●	LANT-CLOE/APIB 8031440361392	●
lumen	1300 lm	lumen	1300 lm	lumen	1300 lm
watt	12W	watt	12W	watt	12W

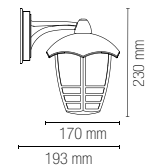
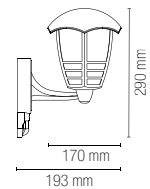
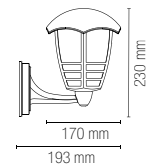

**Accessori integrati /
Built in accessories**



**Sensore di movimento regolabile /
Adjustable motion sensor**

ON	10lux
distanza / distance	1-8m
	90°
5 seconds - 5 minutes	



	colour temp.
LANT-CLOE/S1 8031440361422	●
lumen	1300 lm
watt	12W

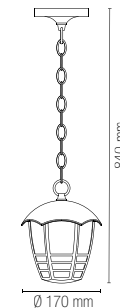

	colour temp.
LANT-CLOE/L1 8031440361415	●
lumen	1300 lm
watt	12W

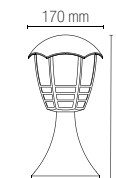

	colour temp.
LANT-CLOE/P1 8031440361439	●
lumen	1300 lm
watt	12W

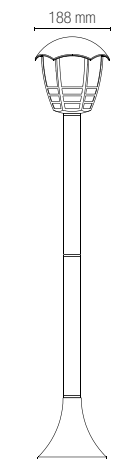

	colour temp.
LANT-CLOE/P3 8031440361446	●
lumen	3900 lm
watt	3 x 12W

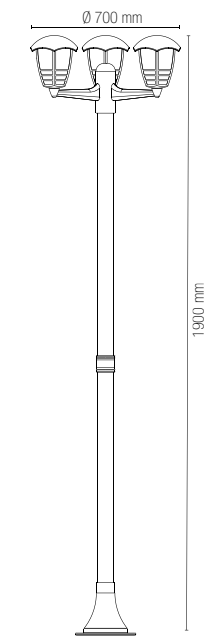



MEGAN

Lanterna LED integrato in alluminio pressofuso
colore nero goffrato diffusore in policarbonato.

Die cast aluminum built-in LED lantern
black embossed finish with PC diffuser.

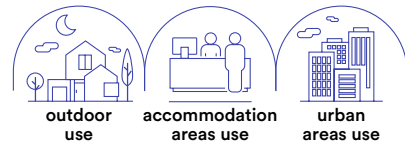

technical information **MEGAN**



Materiale
alluminio pressofuso
+ policarbonato

Colore
goffrato nero

Temperatura colore
4000K

Driver
integrato

Material
die cast aluminum
+ polycarbonate

Colour
embossed black

Colour temperature
4000K

Driver
built-in



	colour temp.		colour temp.		colour temp.
LANT-MEGAN/AP1A 8031440361453	●	LANT-MEGAN/AP1A-S 8031440361460	●	LANT-MEGAN/AP1B 8031440361477	●
lumen	1300 lm	lumen	1300 lm	lumen	1300 lm
watt	12W	watt	12W	watt	12W

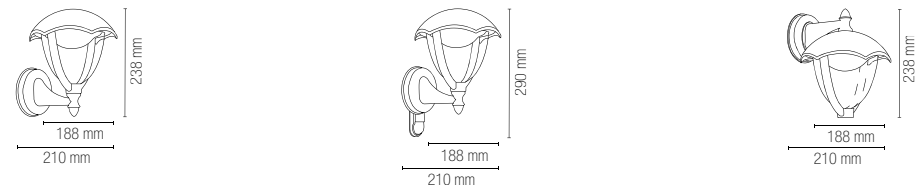

	colour temp.		colour temp.		colour temp.		colour temp.
LANT-MEGAN/S1 8031440361507	●	LANT-MEGAN/L1 8031440361484	●	LANT-MEGAN/P1 8031440361491	●	LANT-MEGAN/P3 8031440361606	●
lumen	1300 lm	lumen	1300 lm	lumen	1300 lm	lumen	3900 lm
watt	12W	watt	12W	watt	12W	watt	3 x 12W

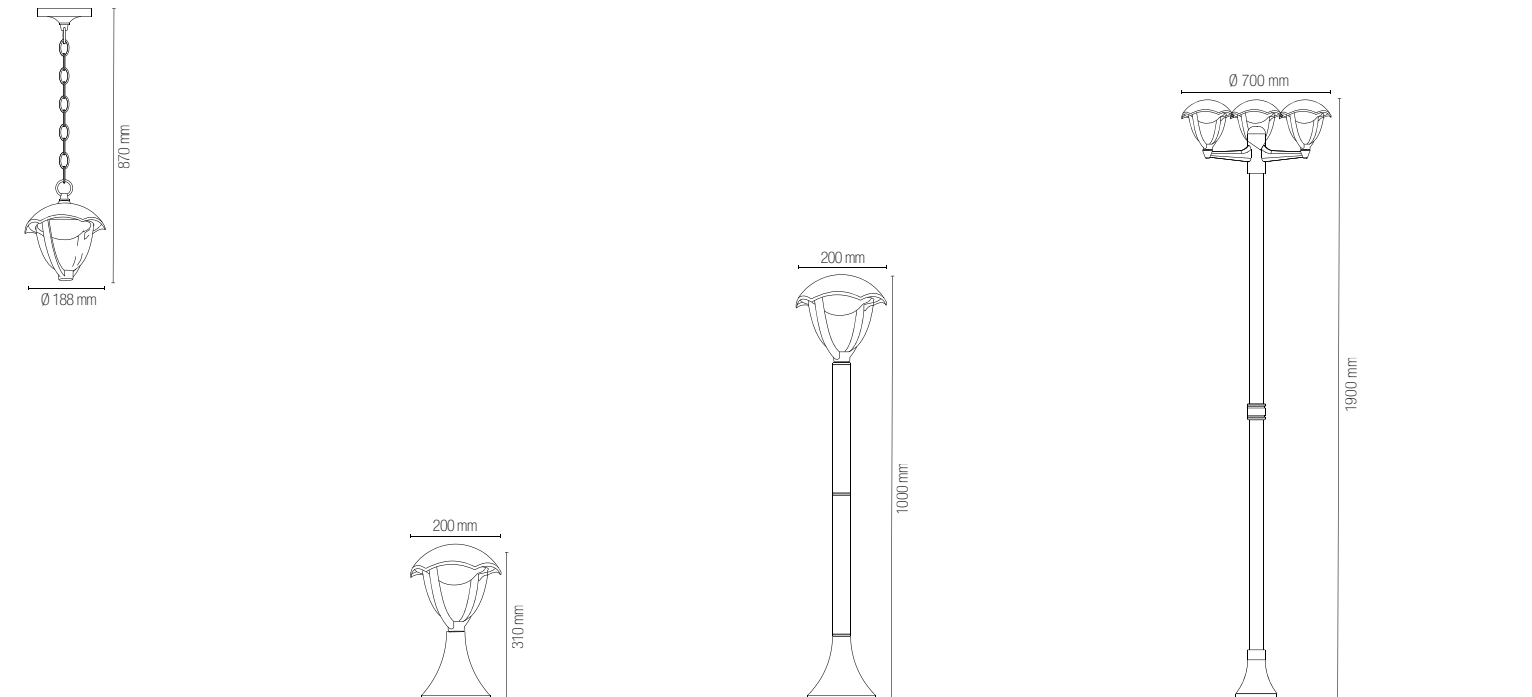

Accessori integrati /
Built in accessories



Sensore di movimento regolabile /
Adjustable motion sensor

ON	10lux
distanza / distance	1-8m
	90°
5 seconds - 5 minutes	

ROMA

Lanterne in alluminio pressofuso con diffusore in vetro trasparente.

Die-cast aluminum lantern with clear glass diffuser.

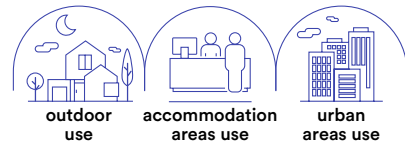

technical information **ROMA**



LANT-ROMA/APIA BCO 8031434661217	colour	LANT-ROMA/API1B BCO 8031434671216	colour	LANT-ROMA/S1 BCO 8031434681215	colour
LANT-ROMA/APIA 8031430751172	●	LANT-ROMA/APIA-S 8031435921235	●	LANT-ROMA/API1B 8031430761171	●
1 x E27 MAX 60W		1 x E27 MAX 60W		1 x E27 MAX 60W	

LANT-ROMA/L1 BCO 8031436951248	colour	LANT-ROMA/P1 BCO 8031436941249	colour	LANT-ROMA/P3 8031430781179	colour	LANT-ROMA-HEAD21 8031414878512	colour
LANT-PALETTO 8031414042203	●	LANT-ROMA/P1 8031430771170	●	●	●	●	
1 x E27 MAX 60W		1 x E27 MAX 60W		3 x E27 MAX 60W		1 x E27 MAX 60W	

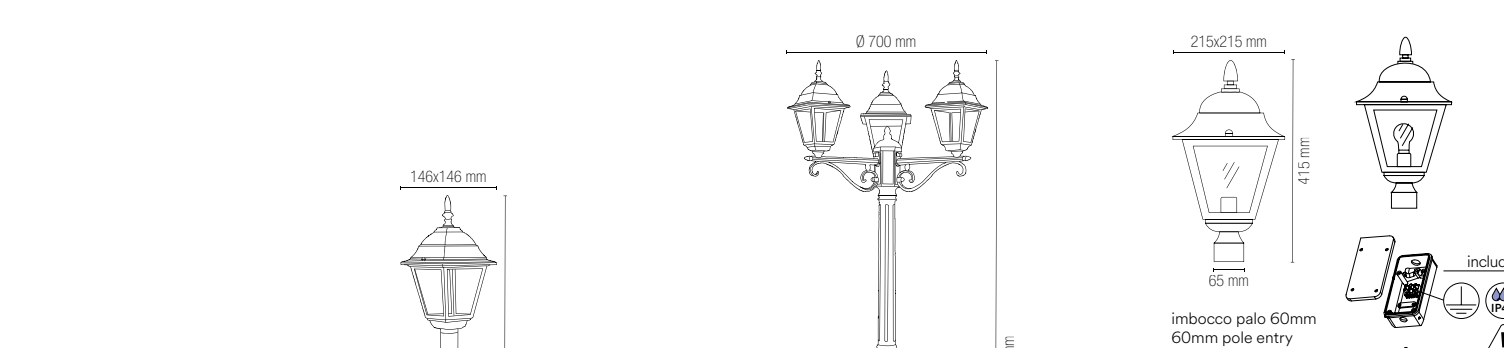
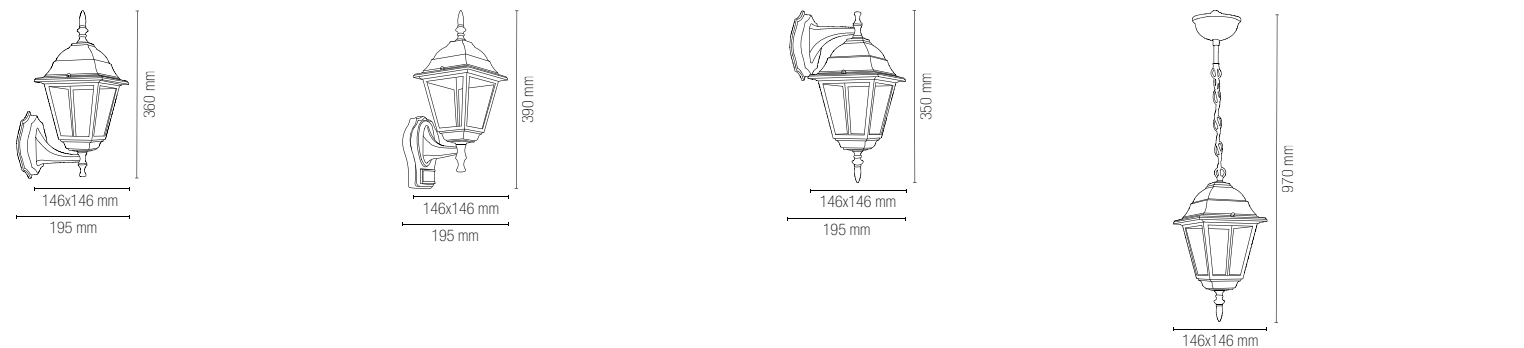

Accessori integrati / Built in accessories

Sensore di movimento regolabile / Adjustable motion sensor

ON	10lux
distanza / distance	1-8m
	90°
5 seconds - 5 minutes	

Lampadina non inclusa / Light bulb not included

on photo: ROMA



on photo: MILANO



In.tec light **OUTDOOR** APPLIQUE, SCOPERSONI E PALETTI CORRELATI / WALL SUSPENSION AND FLOOR LAMPS COMBINED

MILANO

Lanterne in alluminio pressofuso con diffusore in vetro trasparente.

Die-cast aluminum lantern with clear glass diffuser.



technical information **MILANO**



	colour		colour
LANT-MILANO/APIA BCO 8031436931240	●	LANT-MILANO/APIB BCO 8031436911242	●
LANT-MILANO/APIA 8031436921241	●	LANT-MILANO/APIB 8031436901243	●
1 x E27 MAX 60W		1 x E27 MAX 60W	

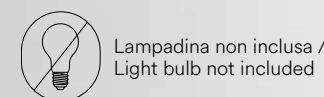
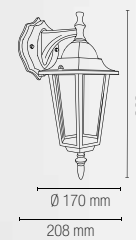
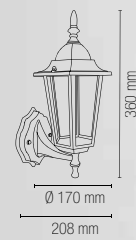

	colour		colour		colour		colour
LANT-MILANO/S1 BCO 8031436851234	●	LANT-MILANO/L1 BCO 8031436891247	●	LANT-MILANO/P1 BCO 8031436871232	●	LANT-MILANO-HEAD23 8031414878529	●
LANT-MILANO/S1 8031436841235	●	LANT-MILANO/L1 8031436881248	●	LANT-MILANO/P1 8031436971246	●		
1 x E27 MAX 60W		1 x E27 MAX 60W		1 x E27 MAX 60W		1 x E27 MAX 60W	

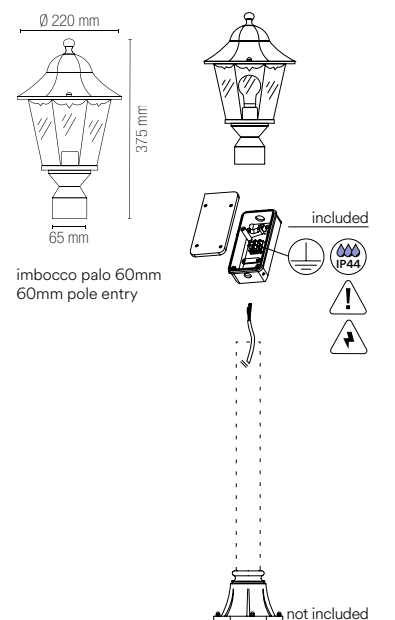
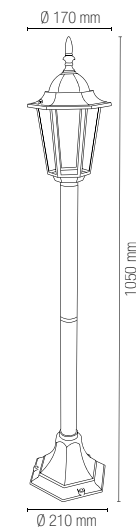
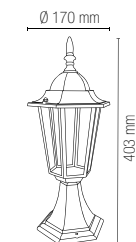
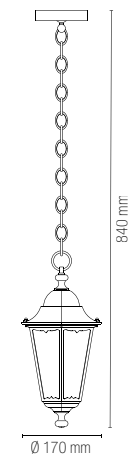

FIRENZE

Lanterne in alluminio pressofuso nero pennellato argento con diffusore in vetro trasparente.

Diecast aluminum lantern black brush silver with clear glass diffuser.





technical information **FIRENZE**

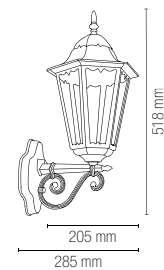

colour 
LANT-FIRENZE/AP1A
8031430701177

1 x E27 MAX 60W



colour 
LANT-FIRENZE/AP1B
8031430711176

1 x E27 MAX 60W

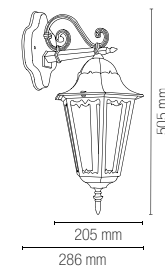

colour 
LANT-FIRENZE/S1
8031430741173

1 x E27 MAX 60W

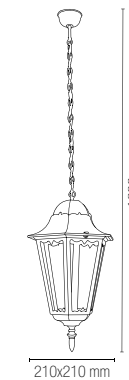

colour 
LANT-FIRENZE/P1
8031430721175

1 x E27 MAX 60W

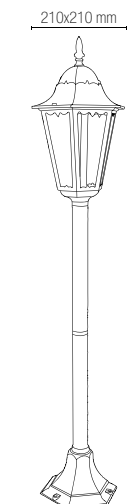

colour 
LANT-FIRENZE/P3
8031430731174

3 x E27 MAX 60W

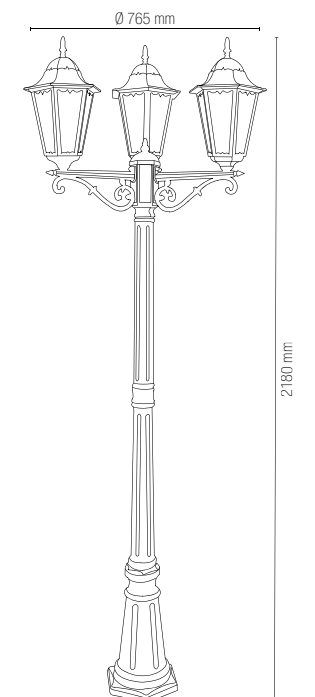

 Lampadina non inclusa /
Light bulb not included

SANTIAGO

Lanterne in alluminio pressofuso nero pennellato
verde con diffusore in vetro trasparente.
Diecast aluminum lantern black
brush green with clear glass diffuser.



technical information **SANTIAGO**



colour ●
LANT-SANTIAGO/AP1A
8031430801174

1 x E27 MAX 60W

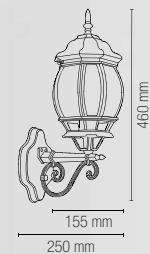

colour ●
LANT-SANTIAGO/AP1B
8031430811173

1 x E27 MAX 60W

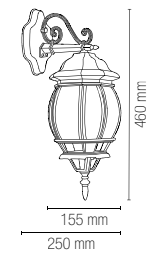

colour ●
LANT-SANTIAGO/S1
8031430841170

1 x E27 MAX 60W



colour ●
LANT-SANTIAGO/P1
8031430821172

1 x E27 MAX 60W

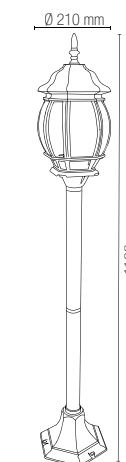

colour ●
LANT-SANTIAGO/P3
8031430831171

3 x E27 MAX 60W

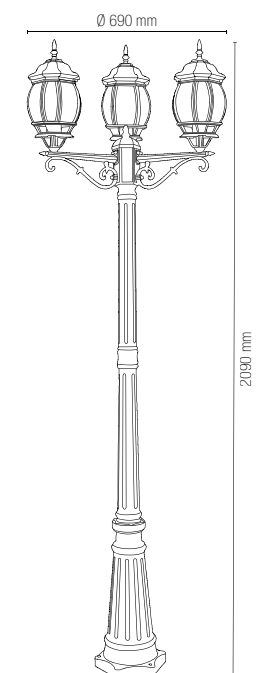

Lampadina non inclusa /
Light bulb not included

on photo: SANTIAGO



on photo: VENEZIA



In.tec light

OUTDOOR APPLIQUE, SCOPERSONI E PALETTI CORRELATI / WALL SUSPENSION AND FLOOR LAMPS COMBINED

VENEZIA

Lanterne in alluminio pressofuso con finiture in colore rame con diffusore in policarbonato trasparente.
Aluminum die-cast lantern with copper colour finish and clear polycarbonate diffuser.



technical information **VENEZIA**



LANT-VENEZIA-AP1A
8031440312004

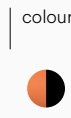

1 x E27 MAX 60W

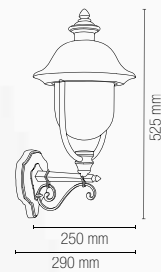

LANT-VENEZIA-AP1B
8031440311991



1 x E27 MAX 60W

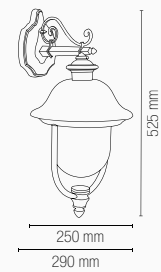

LANT-VENEZIA-S1
8031440313285



1 x E27 MAX 60W

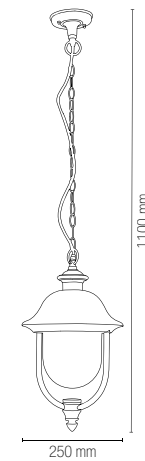

LANT-VENEZIA-L1
8031440311984



1 x E27 MAX 60W

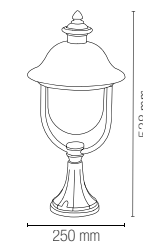

LANT-VENEZIA-P1
8031440313308



1 x E27 MAX 60W

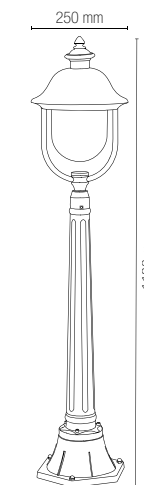

LANT-VENEZIA-P3
8031440313292



3 x E27 MAX 60W

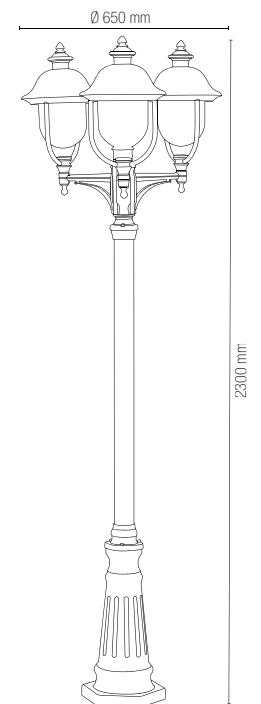

 Lampadina non inclusa /
Light bulb not included

PAVIA

Lanterne in alluminio pressofuso nero goffrato con diffusore in acrilico trasparente.
Die-cast aluminum lantern in embossed black colour with clear acrylic diffuser.

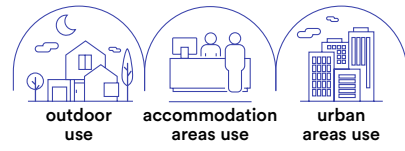

technical information **PAVIA**



	colour		colour		colour		colour
LANT-PAVIA-API 8031440312028	●	LANT-PAVIA-S1 8031440312042	●	LANT-PAVIA-P1 8031440312035	●	LANT-PAVIA-P3 8031440312011	●
1 x E27 MAX 60W		1 x E27 MAX 60W		1 x E27 MAX 60W		3 x E27 MAX 60W	

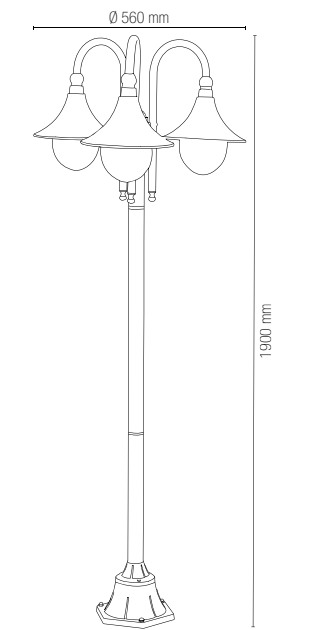
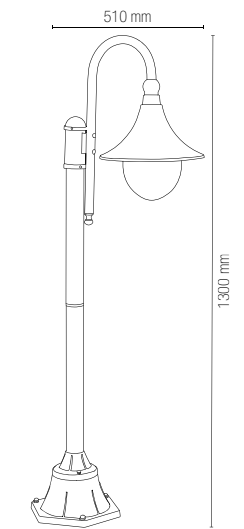
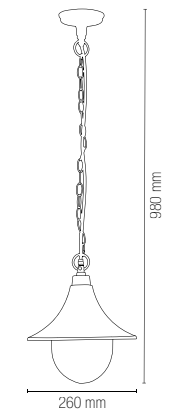
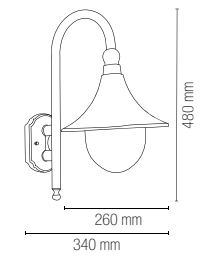

Lampadina non inclusa / Light bulb not included

OUTDOOR APPLIQUE, SCOPERSONI E PALETTI CORRELATI / WALL SUSPENSION AND FLOOR LAMPS COMBINED

In.tec light

BRIGHTMAX

Modulo LED per lampioni con alimentatore OSRAM OT60 dali e mezzanotte virtuale
LED module for lampposts with OSRAM OT60 dali power supply and virtual midnight.

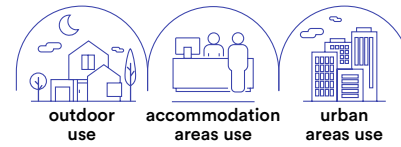

technical information **BRIGHTMAX**



- Materiale**
alluminio
- Colore**
nero
- Temperatura colore**
2700K / 4000K
- Driver incluso**
- Durata e on/off**
50.000h
>25.000 on/off
- Material**
aluminum
- Colour**
black
- Colour temperature**
2700K / 4000K
- Driver included**
- Life time and on/off**
50.000h
>25.000 on/off

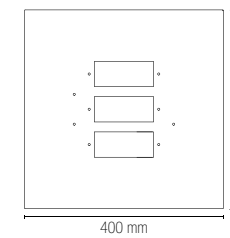
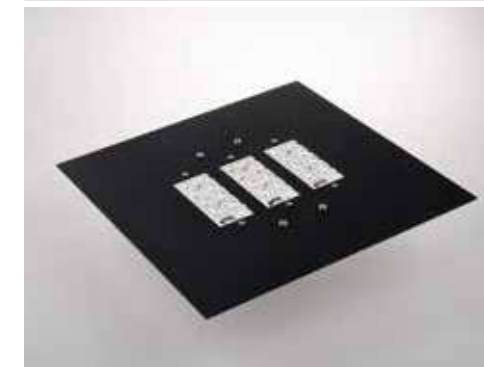

Staffa di fissaggio /
Mounitng bracket

* La piastra può essere tagliata fino a una dimensione di 220x220mm /
* The plate can be cut up to a size of 220x220mm

	colour temp.	colour
BRIGHTMAX-60C 8031414883899 lumen		
BRIGHTMAX-60M 8031414883905 lumen		
watt	60W	
beam angle	360°	

Fotometria del prodotto /
Photometric curve

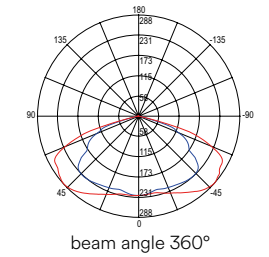

BRIGHTMAX-LENS
8031414883912
Lente bi-asimmetrico e tri-asimmetrico /
Be-asymmetric and three-asymmetric lens

Fotometria del prodotto /
Photometric curve

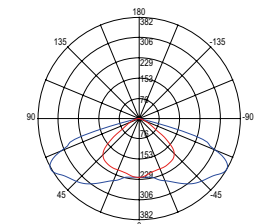

beam angle be-asymmetric

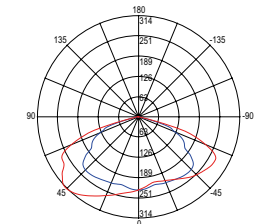

beam angle three-asymmetric

Mezzanotte Virtuale / Virtual Midnight

Sistema indipendente della riduzione della luce in 5 STEP. Il modulo LED è programmato con un determinato programma (personalizzabile su richiesta) per ottimizzare il risparmio energetico durante le ore notturne. L'apparecchio prevede un sistema di autoapprendimento che determina in maniera autonoma, in base alle accensioni e agli spegnimenti pregressi, il punto di Mezzanotte Virtuale. La Mezzanotte Virtuale è il punto che determina la riduzione di flusso in base al profilo impostato, lasciando invariato l'impianto. Per un corretto funzionamento del sistema Mezzanotte Virtuale è necessario un'accensione e uno spegnimento regolare quotidiano.

Independent system of light reduction in 5 steps. The LED module is set with a specific program (customizable) to optimize the energy saving time during night hours. The device is equipped with a auto-feedback system which determine independently, the Virtual Midnight point based on the past switch on-switch-off time record. Virtual Midnight is the point which determines the light flux reduction based on the set profile, keeping the electrical system untouched. For a correct working of the system of Virtual Midnight it is necessary a daily regular cycle of switching on-off.

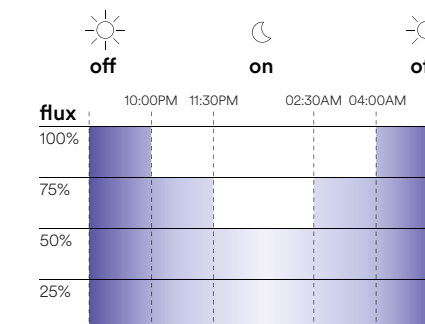

Impostazioni di fabbrica / Default Settings

hours	flux
ON ÷ 10:00	100%
10:00 ÷ 11:30	75%
11:30 ÷ 02:30	50%
02:30 ÷ 04:00	75%
04:00 ÷ OFF	100%

OUTDOOR

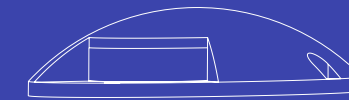

INCASSI E SEGNAPASSI

INGROUND AND WALK LIGHTS

BARRET

Segnapassi incasso.
Recessed light.

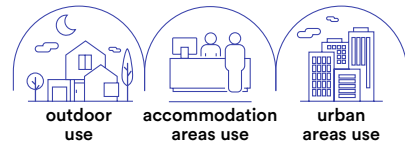

- Materiale**
alluminio
- Colore**
nikel
- Temperatura colore**
3000K / 4000K
- Driver**
350mA 3,5V
corrente costante
non incluso
- Material**
aluminum
- Colour**
nikel
- Colour temperature**
3000K / 4000K
- Driver**
350mA 3,5V
constant current
not included

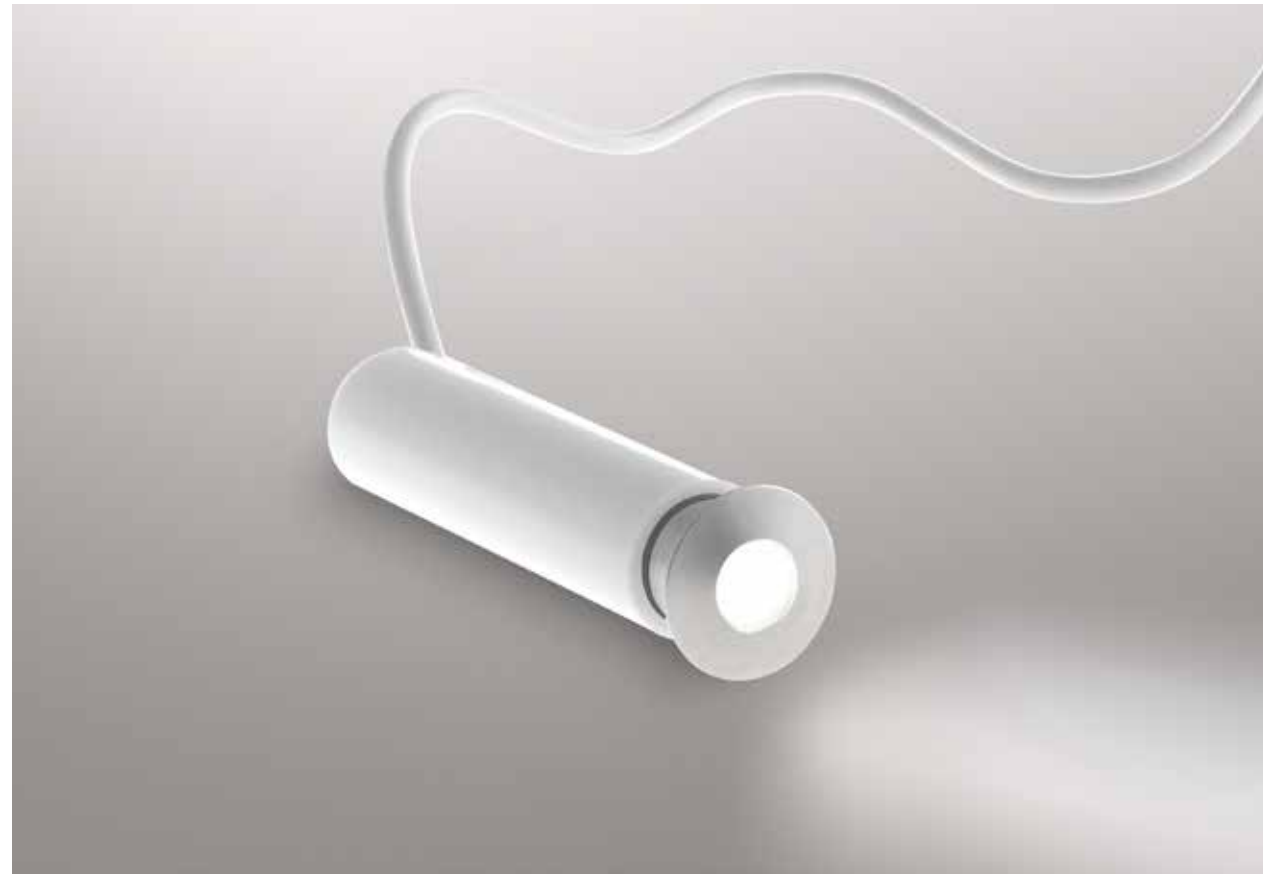

	colour temp.	colour	recessed box
LED-BARRET-R24C 8031440355070	85 lm		Ø 20 mm 80 mm
LED-BARRET-R24 8031440364416	85 lm		Ø 24 mm 35 mm
watt	1W		
driver	3,5V DC		
beam angle	40°		
	Ø 16 mm		

Fotometria del prodotto /
Photometric curve

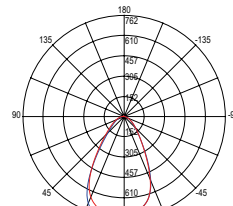

LED-BARRET-R24

Connessione in serie /
Serie connection system

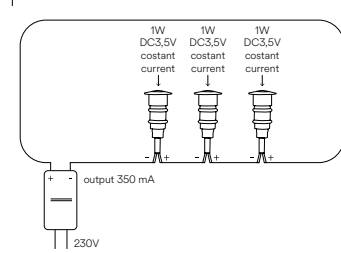

Driver p. 837-846

Accessori inclusi /
Included accessories



x1
Cavo 1 m /
1 m cable

SUBWAY

Segnapassi incasso.
Recessed light.



- Materiale**
alluminio
- Colore**
nikel
- Temperatura colore**
3000K / 4000K / BLU
- Driver**
DC 12-24V
tensione costante
non incluso
- Material**
aluminum
- Colour**
nikel
- Colour temperature**
3000K / 4000K
- Driver**
DC 12-24V
constant voltage
not included



	colour temp.	colour	recessed box
LED-SUBWAY-R1C 8031414879342	385 lm		Ø 32 mm 75 mm
LED-SUBWAY-R1M 8031414877263	420 lm		Ø 22 mm
LED-SUBWAY-R1B 8031414877270	53 lm		
watt	12W		
driver	24V		
beam angle	15°		
	Ø 24 mm		

Fotometria del prodotto /
Photometric curve

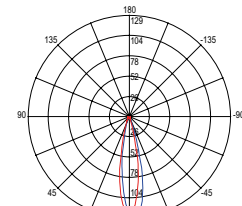

LED-SUBWAY-R1

Connessione in parallelo /
Serie connection system

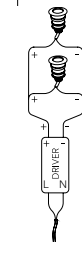

Driver p. 837-846
Controller p. 848-851

Accessori inclusi /
Included accessories

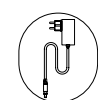

x1
Cavo 1 m /
1 m cable

RIDER

Kit 6 pz segnapassi incasso.
Kit 6pcs recessed light.

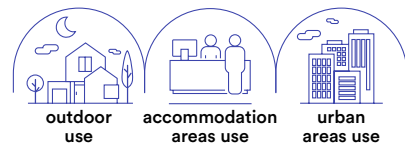

- Materiale**
acciaio
- Colore**
acciaio
- Temperatura colore**
4000K
- Driver**
12V 6W DC
incluso
- Material**
steel
- Colour**
stainless steel
- Colour temperature**
4000K
- Driver**
12V 6W DC
included



LED-RIDER-R6
8031436141236
lumen

watt	6 × 0,6W
driver	12V 6W DC
beam angle	120°
	Ø 23 mm

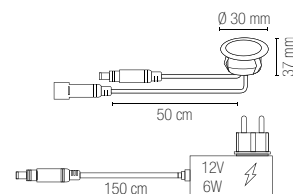

Fotometria del prodotto /
Photometric curve

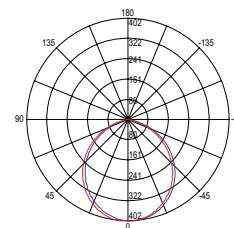

LED-RIDER-R6

Accessori inclusi /
Included accessories

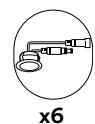

x6



x6

Cavo 1,5 m /
1,5 m cable



IP44

RIDER

Kit 6 pz segnapassi incasso.
Kit 6pcs recessed light.

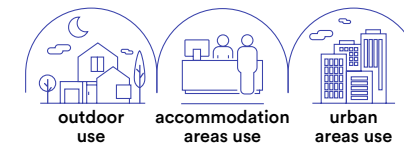

- Materiale**
acciaio
- Colore**
acciaio
- Temperatura colore**
RGB
- Driver**
12V 6W
incluso
- Material**
steel
- Colour**
stainless steel
- Colour temperature**
RGB
- Driver**
12V 6W
included



LED-RIDER-R6-RGB
8031439871260
lumen

watt	6 × 0,6W
driver	12V 6W DC
beam angle	120°
	Ø 23 mm

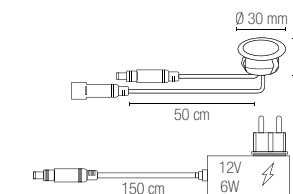

Accessori inclusi /
Included accessories

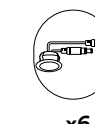

x6

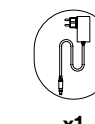

x1

Cavo 1,5 m /
1,5 m cable



IP44



IR

Control system

RIDER

Kit 6 pz segnapassi incasso.
Kit 6pcs recessed light.

Materiale
lega di zinco

Colore
silver

Temperatura colore
4000K

Driver

12V 6W DC
incluso

Material
zinc alloy

Colour
silver

Colour temperature
4000K

Driver

12V 6W DC
included

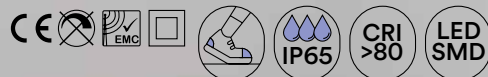

LED-RIDER-R6-DIR

8031439921279

lumen 100 lm

watt 6 x 0,6W

driver 12V 6W DC

beam angle 105°

Ø 23 mm

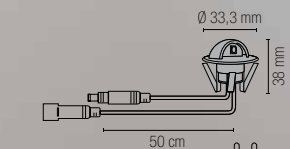

Fotometria del prodotto / Photometric curve

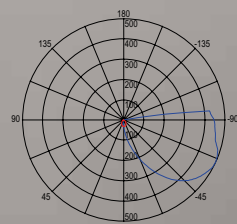

LED-RIDER-R6-DIR

Accessori inclusi / Included accessories

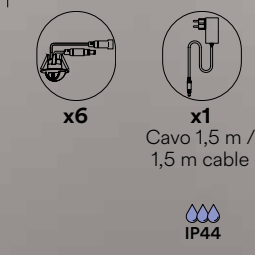

x1
Cavo 1,5 m /
1,5 m cable

IP44

IMPACT

Segnapassi incasso in alluminio.
Aluminum recessed steplight.

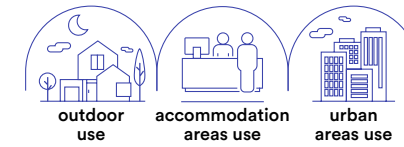

Materiale
alluminio

Colore
nikel

Temperatura colore
3000K / 4000K

Driver

DC 24V
tensione costante
non incluso

Material
aluminum

Colour
nikel

Colour temperature
3000K / 4000K

Driver

DC 24V
constant voltage
not included



Connessione in parallelo /
Serie connection system
Driver p. 837-846
Controller p. 848-851



EASY DOMOTICA



LED-IMPACT24V-R1C

8031414879298

lumen 170 lm

LED-IMPACT24V-R1M

8031414879304

lumen 170 lm

watt 2W

driver DC 24V

beam angle 105°

Ø 35 mm



recessed box

Ø 35 mm

90 mm

Ø 40 mm

57 mm

Fotometria del prodotto / Photometric curve

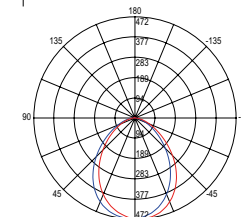

LED-IMPACT24V-R1C
LED-IMPACT24V-Q1C

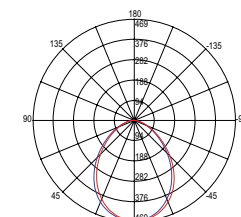

LED-IMPACT24V-R1M
LED-IMPACT24V-Q1M

Accessori inclusi / Included accessories

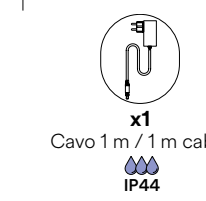

x1
Cavo 1 m / 1 m cable

IP44

OUTDOOR INCASSI E SEGNAPASSI / INGROUND AND WALK LIGHTS

In.tec light

STEP

Segnapassi incasso in alluminio.
Aluminum recessed steplight.

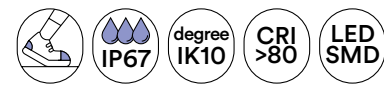
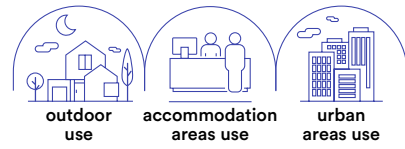

technical information **STEP**

EASY DOMOTICA



- Materiale**
alluminio
- Colore**
silver
- Temperatura colore**
3000K / 4000K
- Driver**
DC 24V
tensione costante
non incluso
- Material**
aluminum
- Colour**
silver
- Colour temperature**
3000K / 4000K
- Driver**
DC 24V
constant voltage
not included



	colour temp.	colour	recessed box
LED-STEP24V-R1C 8031414879250	170 lm		
LED-STEP24V-R1M 8031414879267	170 lm		
watt	2W		
driver	DC 24V		
beam angle	105°		
	Ø 35 mm		

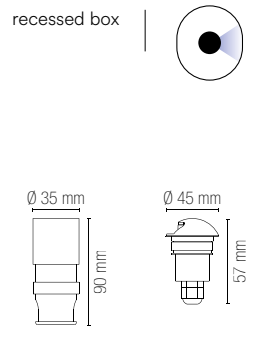

	colour temp.	colour	recessed box
LED-STEP24V-R4C 8031414879274	170 lm		
LED-STEP24V-R4M 8031414879281	170 lm		
watt	2W		
driver	DC 24V		
beam angle	105°		
	Ø 35 mm		

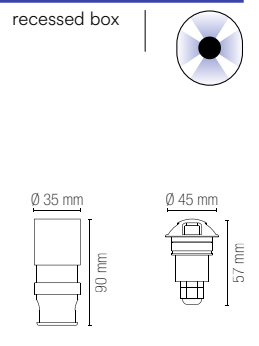

Connessione in parallelo /
Serie connection system
Driver p. 837-846
Controller p. 848-851

Fotometria del prodotto / Photometric curve

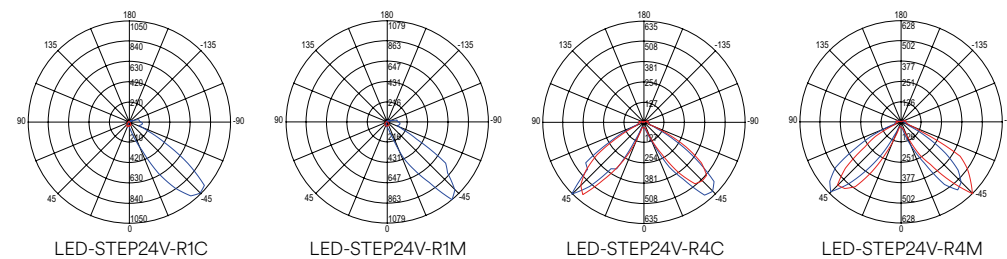

Accessori inclusi /
Included accessories

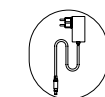

x1
Cavo 1 m /
1 m cable

WALK

Faro calpestabile ad incasso in acciaio inox.
Walkable recessed light in stainless steel.

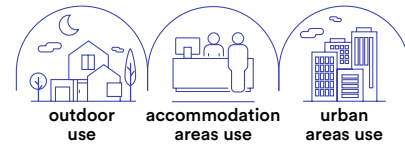

collection **WALK**

- Materiale**
acciaio inox

- Temperatura colore**
4000K
-
- Driver**
integrato

- Material**
stainless steel

- Colour temperature**
4000K
-
- Driver**
built-in





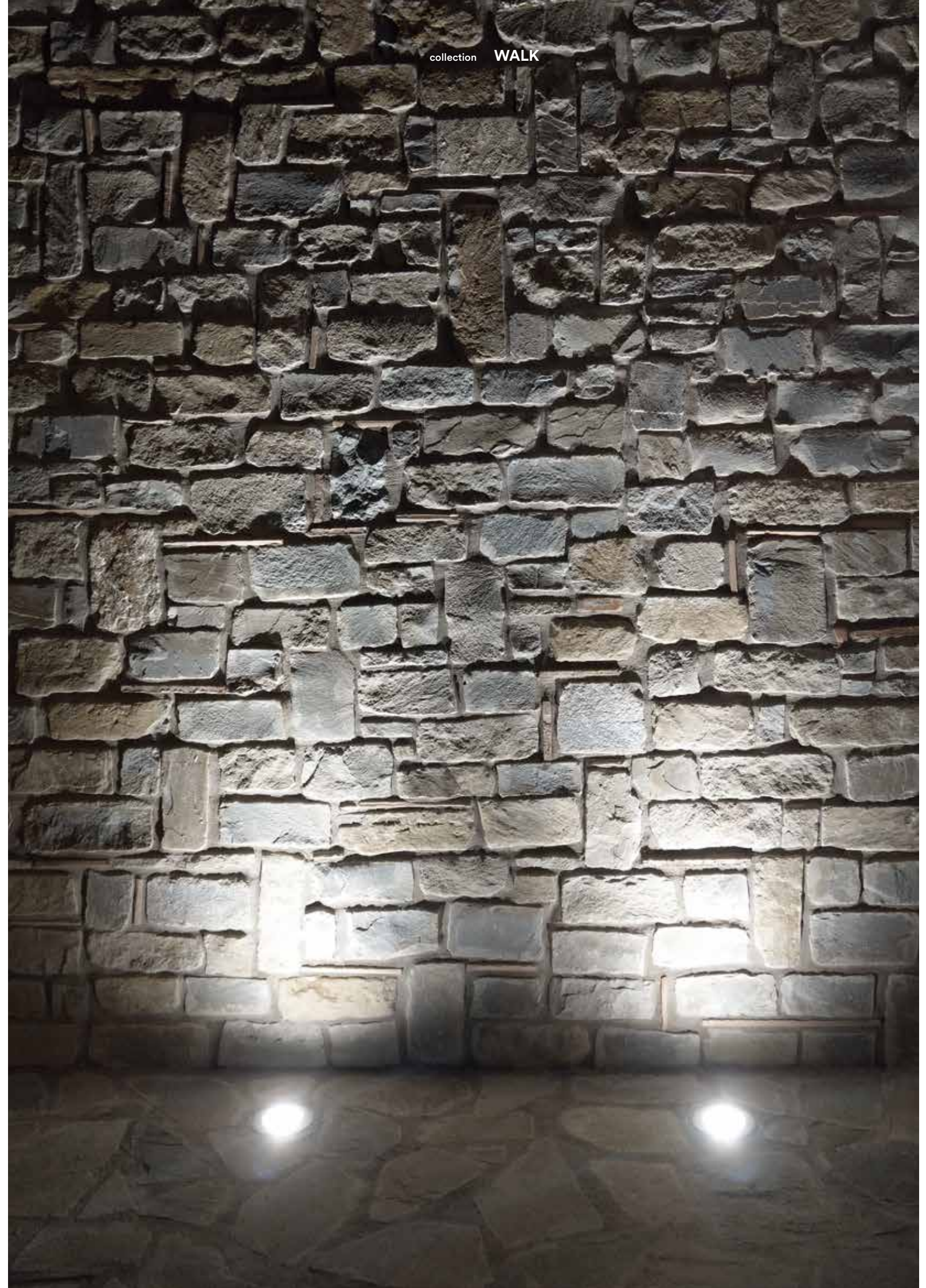



colour temp.	●	●	recessed box
lumen	1500 lm		
watt	12W		
beam angle	30°		



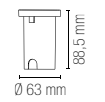
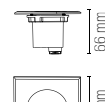

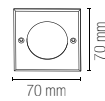

In.tec light **OUTDOOR** INCASSI E SEGNAPASSI / INGROUND AND WALK LIGHTS





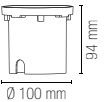
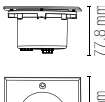

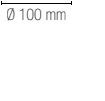
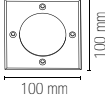

	colour temp.	colour	recessed box
LED-WALK-Q7C 8031414885824			 
lumen	345 lm		
LED-WALK-Q7 8031440355599			 
lumen	375 lm		
watt		3W	
beam angle		30°	



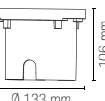
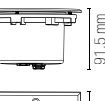



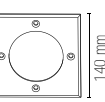

	colour temp.	colour	recessed box
LED-WALK-Q11C 8031414885800			 
lumen	930 lm		
LED-WALK-Q11 8031440355575			 
lumen	990 lm		
watt		8W	
beam angle		30°	

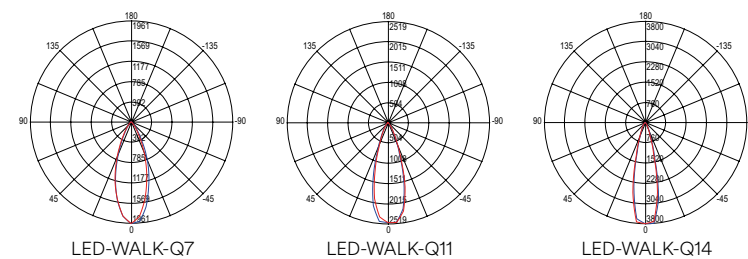



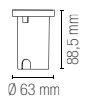
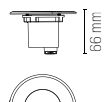

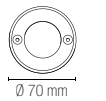

	colour temp.	colour	recessed box
LED-WALK-Q14C 8031414885817			 
lumen	1400 lm		
LED-WALK-Q14 8031440355551			 
lumen	1500 lm		
watt		12W	
beam angle		30°	

Fotometria del prodotto / Photometric curve



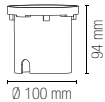
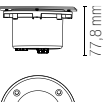



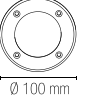

	colour temp.	colour	recessed box
LED-WALK-R7C 8031414885855			 
lumen	345 lm		
LED-WALK-R7 8031440355582			 
lumen	375 lm		
watt		3W	
beam angle		30°	

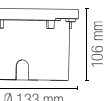
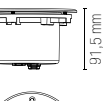

	colour temp.	colour	recessed box
LED-WALK-R11C 8031414885831			 
lumen	930 lm		
LED-WALK-R11 8031440355568			 
lumen	990 lm		
watt		8W	
beam angle		30°	

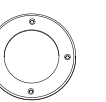

	colour temp.	colour	recessed box
LED-WALK-R14C 8031414885848			 
lumen	1400 lm		
LED-WALK-R14 8031440355544			 
lumen	1500 lm		
watt		12W	
beam angle		30°	

Fotometria del prodotto / Photometric curve

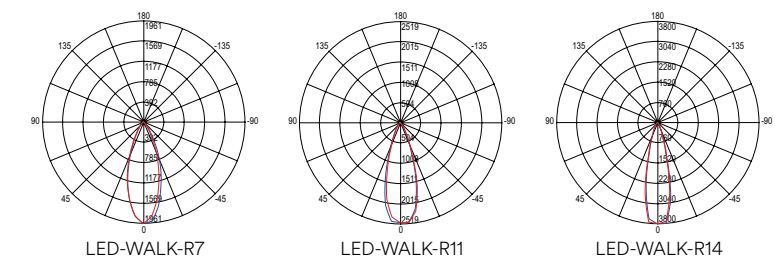

HUMMER

Faro carrabile ad incasso in acciaio inox.
Driveover recessed light in stainless steel.



technical information **HUMMER**



I-HUMMER-R1
8031414893188
I-HUMMER-R1-ANT
8031414895830
I-HUMMER-R1-BRO
8031414893195

1 x GU10 MAX 35W

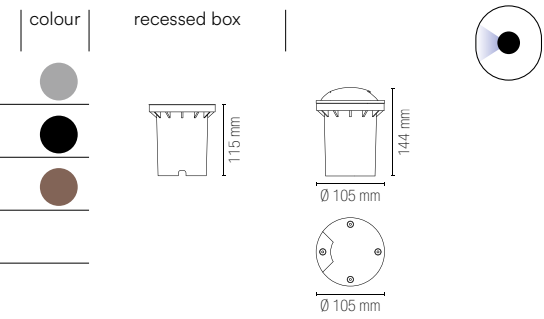

Lampadina non inclusa / Light bulb not included



I-HUMMER-R2
8031414893201
I-HUMMER-R2-ANT
8031414895847
I-HUMMER-R2-BRO
8031414893218

1 x GU10 MAX 35W

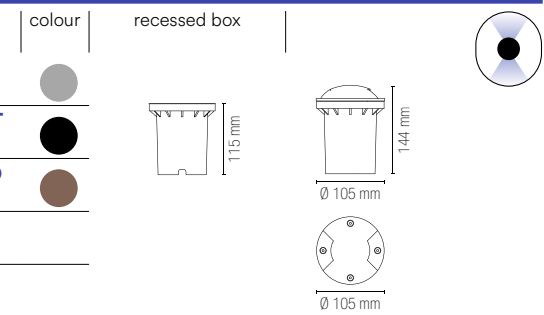

Lampadina non inclusa / Light bulb not included



I-HUMMER-R4
80314148772249
I-HUMMER-R4-ANT
8031414895854
I-HUMMER-R4-BRO
8031414893225

1 x GU10 MAX 35W

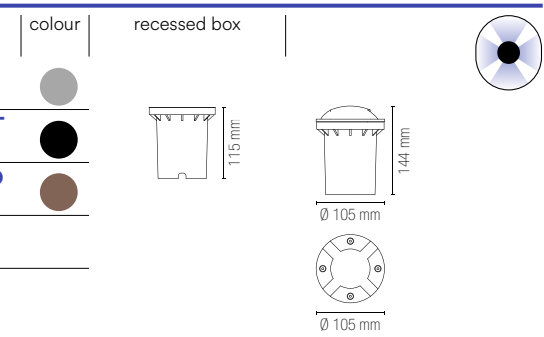

Lampadina non inclusa / Light bulb not included



I-HUMMER-UP
8031414893232
I-HUMMER-UP-ANT
8031414895861
I-HUMMER-UP-BRO
8031414893249

1 x GU10 MAX 35W

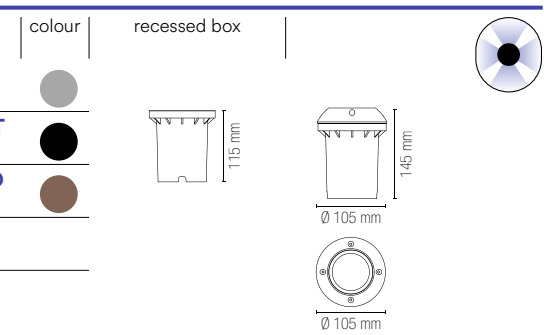

Lampadina non inclusa / Light bulb not included

DRIVE

Faro calpestabile ad incasso in acciaio inox.
Walkable recessed light in stainless steel.

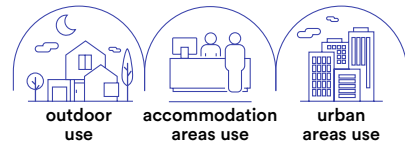

technical information **DRIVE**



colour | recessed box |

I-DRIVE-R1
8031440313261

1 x GU10 MAX 42W

118 mm
111 mm
Ø 103 mm
Ø 108 mm

Lampadina non inclusa /
Light bulb not included



colour | recessed box |

I-DRIVE-Q1
8031440313254

1 x GU10 MAX 42W

118 mm
111 mm
108 mm
108 mm

Lampadina non inclusa /
Light bulb not included



colour | recessed box |

I-DRIVE-M-R1
8031440313247

1 x GU10 MAX 42W

60°

150 mm
134 mm
Ø 134 mm
Ø 140 mm

Lampadina non inclusa /
Light bulb not included



colour | recessed box |

I-DRIVE-E27
8031440313230

1 x E27 MAX 60W

247 mm
243 mm
Ø 180 mm
Ø 186 mm

Lampadina non inclusa /
Light bulb not included

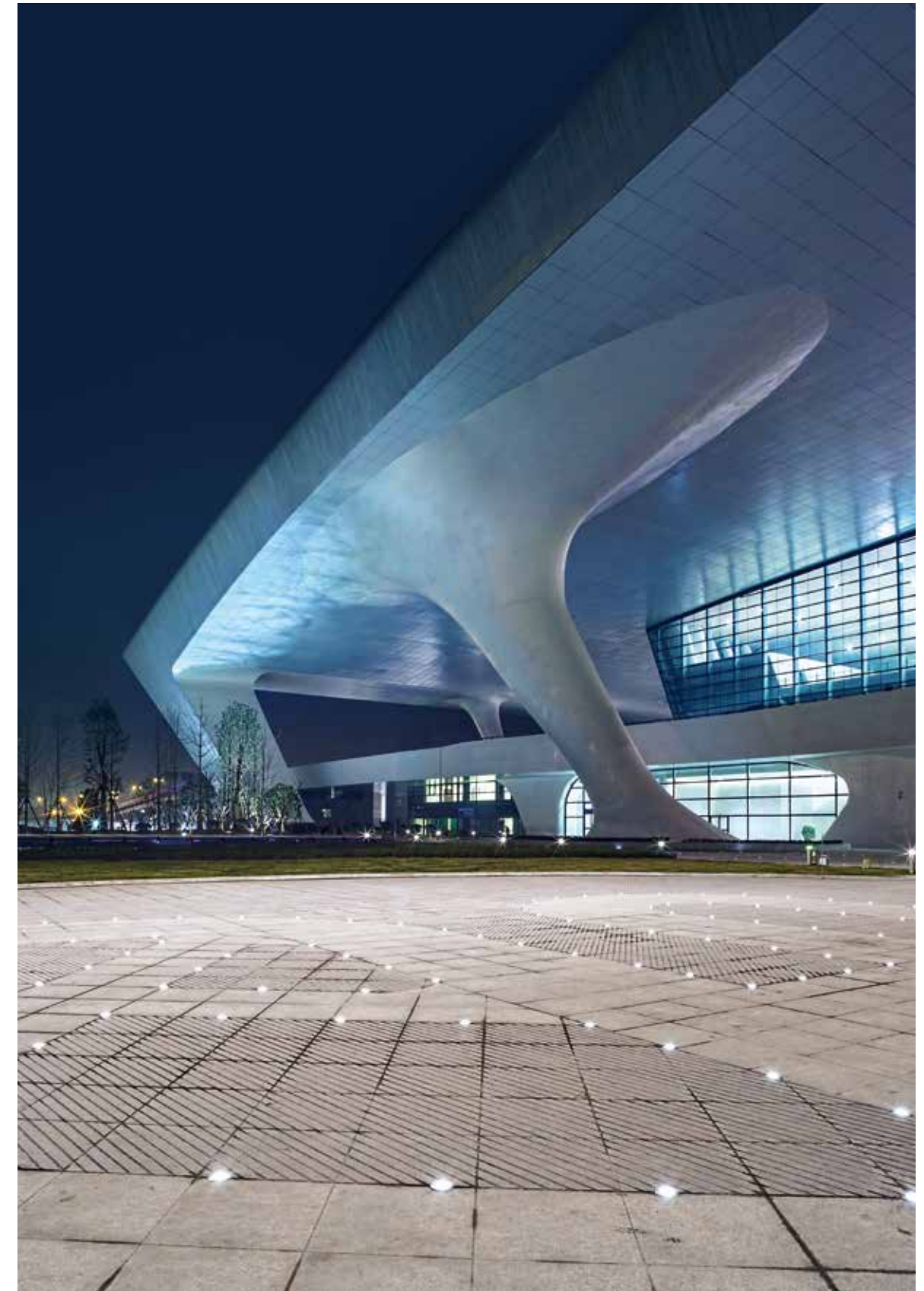

Segnapassi in alluminio pressofuso.
Die-cast aluminum steplight.



technical information **ELMO**



Materiale
alluminio

Colore
silver

Temperatura colore
3000K / 4000K



Driver
DC 24V
tensione costante
non incluso

Material
aluminum

Colour
silver

Colour temperature
3000K / 4000K



Driver
DC 24V
constant voltage
not included

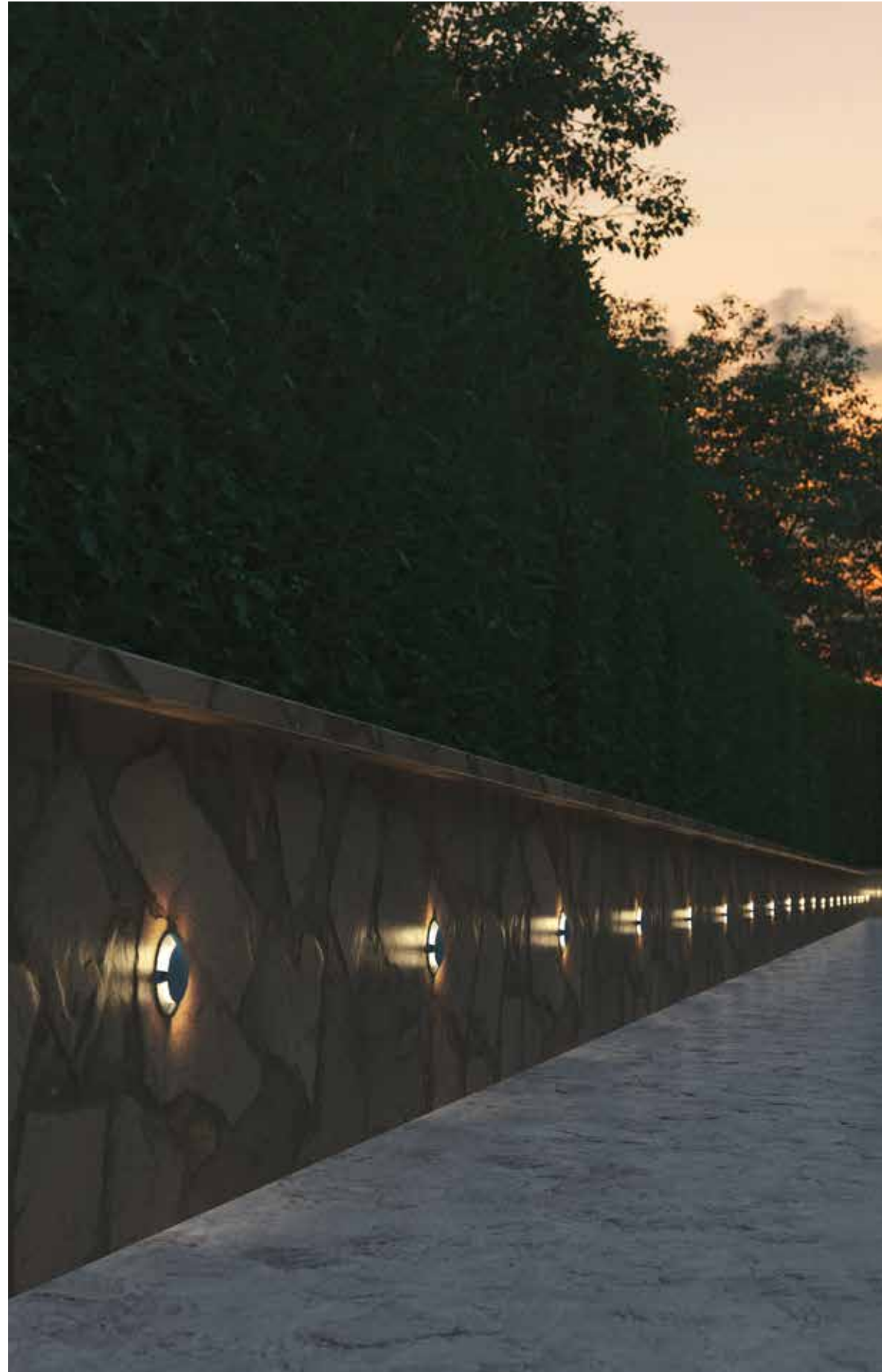

	colour temp.	colour
LED-ELMO-R1C 8031414882823 lumen		
LED-ELMO-R1M 8031414882830 lumen		
watt	0,5W	
beam angle	90°	

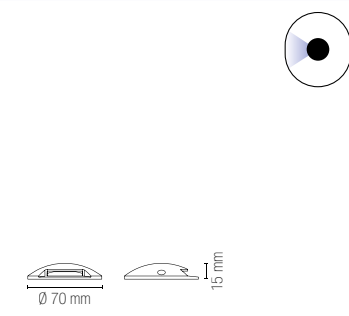

	colour temp.	colour
LED-ELMO-R2C 8031414882847 lumen		
LED-ELMO-R2M 8031414882854 lumen		
watt	1W	
beam angle	90° x 2	

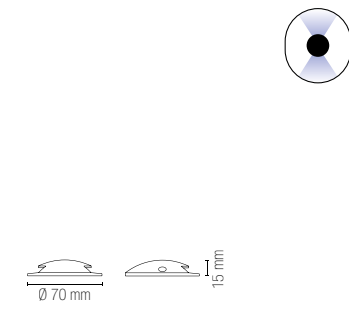

	colour temp.	colour
LED-ELMO-R4C 8031414882861 lumen		
LED-ELMO-R4M 8031414882878 lumen		
watt	2W	
beam angle	90° x 4	

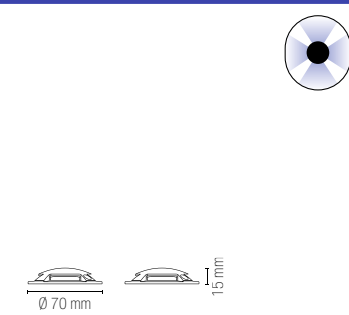

	colour temp.	colour
LED-ELMO-UPC 8031414897247 lumen		
LED-ELMO-UPM 8031414897254 lumen		
watt	3W	
beam angle	180°	

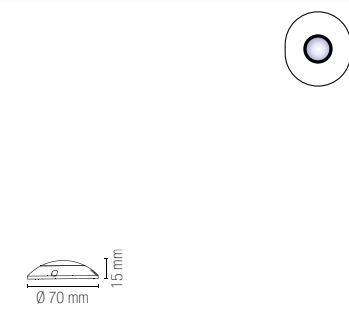

I-ELMO-SPK
8031414888092

**Accessori inclusi /
Included accessories**



x1
Cavo 30 cm /
30 cm cable

GROUND

Segnapassi in alluminio pressofuso colore antracite.
Die-cast aluminum steplight in anthracite colour.

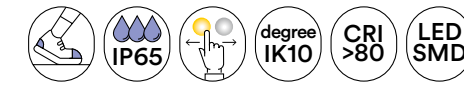

technical information **GROUND**



Materiale
alluminio

Colore
antracite

**Temperatura colore
selezionabile**
3000K / 4000K



Driver
DC 24V
tensione costante
non incluso

Material
aluminum

Colour
anthracite

**Selectable color
temperature**
3000K / 4000K



Driver
DC 24V
constant voltage
not included



LED-GROUND-R1
8031414897261
lumen 730 lm
watt 6W
beam angle 120°

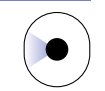
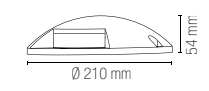
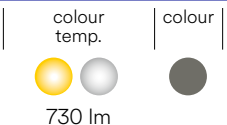

LED-GROUND-R2
8031414897278
lumen 1460 lm
watt 12W
beam angle 120°

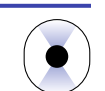
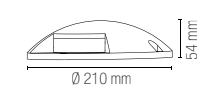
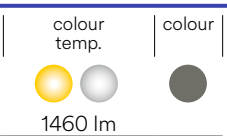

LED-GROUND-R4
8031414897285
lumen 1960 lm
watt 16W
beam angle 120°

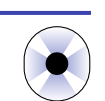
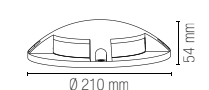
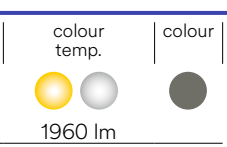

LED-GROUND-UP
8031414897292
lumen 1480 lm
watt 12W
beam angle 120°

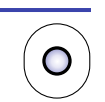
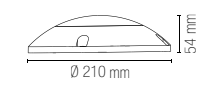
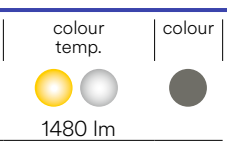

LED-GROUND-SPK
8031414897308

**Accessori inclusi /
Included accessories**

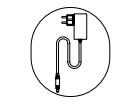

x1
Cavo 1 m /
1 m cable

In.tec light **OUTDOOR** INCASSI E SEGNAPASSI / INGROUND AND WALK LIGHTS

Segnapassi in alluminio pressofuso finitura nero o bianco goffrato.
Die-cast aluminum steplight in embossed black or white finish.

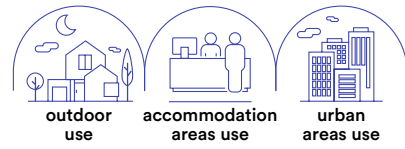

technical information **ONYX**



- Materiale**
alluminio
- Colore**
bianco
nero
- Temperatura colore**
4000K
- Driver**
integrato
- Material**
aluminum
- Colour**
white
black
- Colour temperature**
4000K
- Driver**
built-in



	colour temp.	colour
INC-ONYX-Q1 BCO 8031414864089 lumen		
INC-ONYX-Q1 NERO 8031440361262 lumen		
	420 lm	420 lm
watt	2W	
beam angle	45°	
	Ø 68 mm	

recessed box

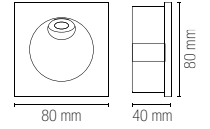
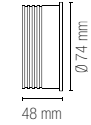

	colour temp.	colour
INC-ONYX-R1 BCO 8031440361248 lumen		
INC-ONYX-R1 NERO 8031440361255 lumen		
	420 lm	420 lm
watt	2W	
beam angle	45°	
	Ø 68 mm	

recessed box

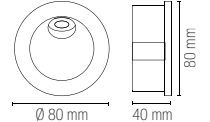
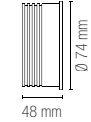

STRATOS

Incasso segnapassi alloggio in cassetta di derivazione 503 o 504 o 506, con mascherine in alluminio nei colori bianco, antracite, silver o corten.

Downlight for recess box 503, 504 or 506, with aluminum masks in white, anthracite, silver or corten.



technical information **STRATOS**



- Materiale**
alluminio
- Colore**
bianco
silver
nero
corten
- Temperatura colore selezionabile**
3000K / 4000K / 6000K
- Driver**
integrato
- Material**
aluminum
- Colour**
white
silver
black
corten
- Selectable color temperature**
3000K / 4000K / 6000K
- Driver**
built-in



Model	Part Number	Colour Temp. Options	Lumen	Watt	Beam Angle
INC-STRATOS-503	8031414888184	3000K, 4000K, 6000K	360 lm	3W	120°
INC-STRATOS-504	8031414888221	3000K, 4000K, 6000K	360 lm	3W	120°
INC-STRATOS-506	8031414888276	3000K, 4000K, 6000K	600 lm	5W	120°

Model	Part Number	Colour Options
INC-STRATOS-503W	8031414886890	White
INC-STRATOS-503S	8031414888214	Silver
INC-STRATOS-503B	8031414888191	Black
INC-STRATOS-503C	8031414888207	Corten
INC-STRATOS-504W	8031414888269	White
INC-STRATOS-504S	8031414888252	Silver
INC-STRATOS-504B	8031414888238	Black
INC-STRATOS-504C	8031414888245	Corten
INC-STRATOS-506W	8031414888313	White
INC-STRATOS-506S	8031414888306	Silver
INC-STRATOS-506B	8031414888283	Black
INC-STRATOS-506C	8031414888290	Corten



scatola derivazione 503
503 junction box
non inclusa / not included

scatola derivazione 503
503 junction box
non inclusa / not included

scatola derivazione 504
504 junction box
non inclusa / not included

scatola derivazione 506L
506L junction box
non inclusa / not included

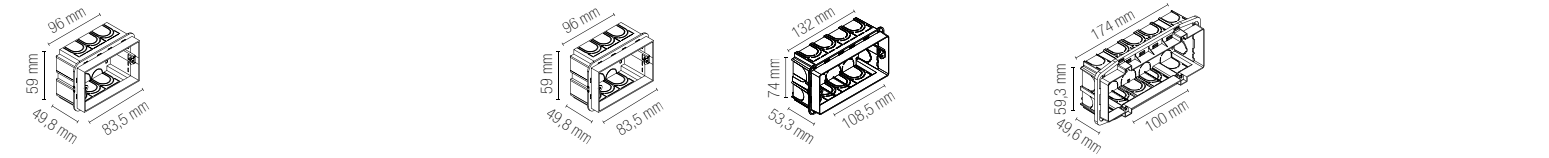

OUTDOOR INCASSI E SEGNAPASSI / INGROUND AND WALK LIGHTS
In.tec light

SLAB

Incasso segnapassi alloggio in cassetta di derivazione
503 o 502 o 506, con diffusore in vetro temperato bianco.

Down light for recess box 503 or 502 or 506
with white tempered glass diffuser.



Materiale

struttura in alluminio e diffusore in vetro temperato

Temperatura colore

4000K

Temperatura colore selezionabile

3000K / 4000K / 5500K



Driver

integrato

Material

structure in aluminum and tempered glass diffuser

Colour temperature

4000K

Selectable color temperature

3000K / 4000K / 5500K



Driver

built-in

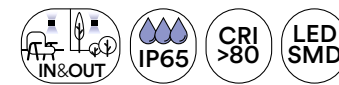

technical information **SLAB**



INC-SLAB-502
8031414888177
lumen

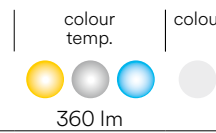

watt 3W
beam angle 120°
Ø 60 mm

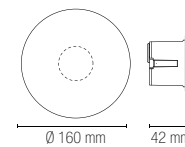

molle incluse / spring included



INC-SLAB-503
8031414864683
lumen

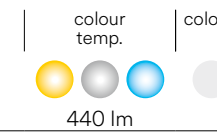

watt 3W
beam angle 120°
92 × 55 × 31 mm

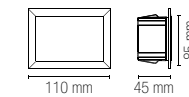

INC-SLAB-506
8031414877232
lumen

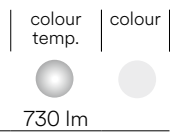

watt 5W
beam angle 120°
163 × 60 × 50 mm

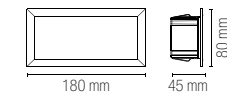

Doppio sistema di fissaggio / Double fixing system

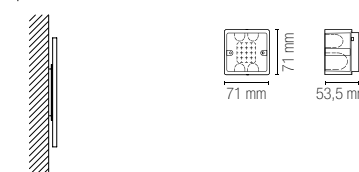

fissaggio incasso a muro o soffitto / Recessed wall or ceiling mounting

scatola derivazione 502E
502E junction box
non inclusa / not included

scatola derivazione 503
503 junction box
non inclusa / not included

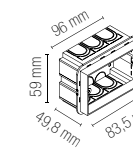

scatola derivazione 506L
506L junction box
non inclusa / not included

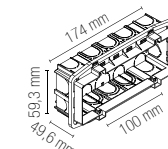



BREEN

Incasso segnapassi alloggio in cassetta di derivazione 503 o 506, nei colori bianco, antracite gofrato o corten.
Downlight for recess box 503 or 506 in white, embossed anthracite or corten.

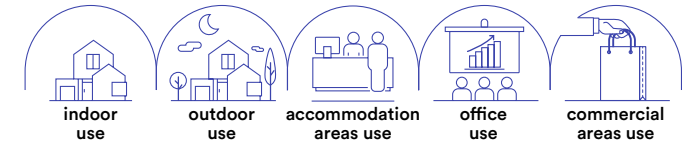

Materiale

polycarbonato

Colore

bianco gofrato
antracite gofrato
corten



Temperatura colore

4000K



Temperatura colore selezionabile

3000K / 3500K / 4000K



Driver

integrato

Material

polycarbonate

Colour

embossed white
embossed anthracite
corten



Colour temperature

4000K



Selectable color temperature

3000K / 3500K / 4000K



Driver

built-in

Doppio sistema di fissaggio / Double fixing system



fissaggio a muro / wall fixing

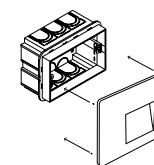

fissaggio su cassetta 503 / fixing on box 503
non inclusa / not included

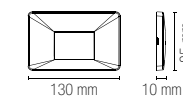

scatola derivazione 503
503 junction box
non inclusa / not included

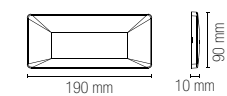
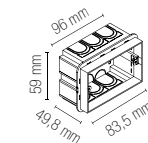

scatola derivazione 506L
506L junction box
non inclusa / not included

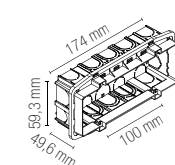

	colour temp.	colour		colour temp.	colour		
INC-BREEN-503 BCO 8031414864690 lumen							
		290 lm			380 lm		
INC-BREEN-503 ANT 8031414866809 lumen							
		300 lm			380 lm		
INC-BREEN-503 BRO 8031414888139 lumen							
		290 lm			380 lm		
watt			3W		4W		
				INC-BREEN-506 BCO 8031414888153 lumen			
						380 lm	
				INC-BREEN-506 ANT 8031414888146 lumen			
						380 lm	
				INC-BREEN-506 BRO 8031414888160 lumen			
						380 lm	
				watt			

OUTDOOR INCASSI E SEGNAPASSI / INGROUND AND WALK LIGHTS

In.tec light

SMILE

Applique segnapassi a LED doppio fissaggio.
Fissaggio a muro e su cassetta 502E.

Aluminum LED walk light double mounting system.
Wall or 502E junction box mounting.



technical information **SMILE**



Materiale
alluminio

Colore
bianco
nero



Temperatura colore
4000K



Driver
integrato

Material
aluminum

Colour
white
black



Colour temperature
4000K



Driver
built-in



LED-SMILE-BCO
8031414881574
lumen

colour temp.	colour
300 lm	

watt	2,5W
beam angle	100°

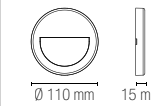

Doppio sistema di fissaggio / Double fixing system



fissaggio a muro /
wall fixing

fissaggio su cassetta 502E /
fixing on box 502E
non inclusa / not included



LED-SMILE-ANT
8031414881567
lumen

colour temp.	colour
300 lm	

watt	2,5W
beam angle	100°

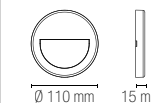

Doppio sistema di fissaggio / Double fixing system



fissaggio a muro /
wall fixing

fissaggio su cassetta 502E /
fixing on box 502E
non inclusa / not included

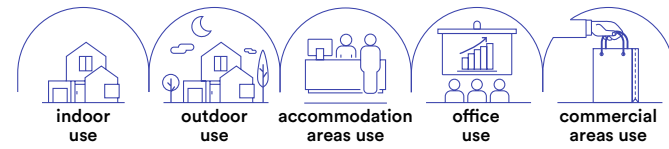

Materiale
alluminio e
placchette in acciaio

Colore
nikel
bianco



Temperatura colore
4000K



Driver
integrato

Material
aluminum and
steel frames

Colour
nikel
white



Colour temperature
4000K



Driver
built-in

**Incasso segnapassi alloggio in cassetta di derivazione 503
funzione con sensore di movimento e crepuscolare con doppia
placchetta in acciaio intercambiabile nei colori nikel o bianco.**
Down light for recess box 503 and double sensor function
motion and crepuscular with double interchangeable
steel frame in nikel or white colours.

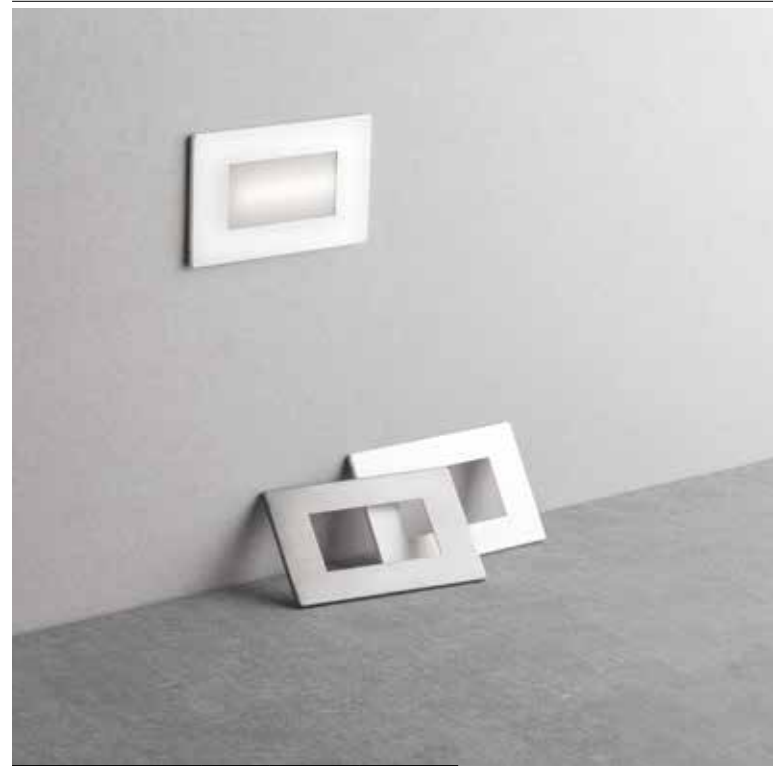

INC-BOLT-503S
8031414866281
lumen 200 lm

watt 3W
beam angle 120°

Installare più prodotti lateralmente
ad una distanza minimo di 2 m /
Install multiple bolt 503S within
2 m of each other



Non installare i prodotti uno di
fronte all'altro per possibile conflitto /
Do not install products one of facing
each other for possible conflict



Il prodotto non va installato
vicino ad una fonte di luce intensa
e costante superiore di 20 LUX /
Do not install the bolt 503S
near a light source with
intensity over 20 LUX

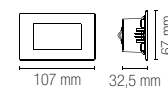
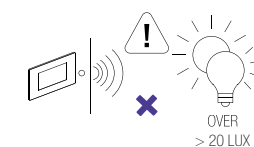

scatola derivazione 503
503 junction box
non inclusa / not included

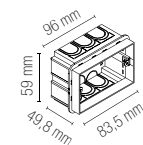

**Accessori inclusi /
Included accessories**



2x
placchette /
frames



2x
staffette /
brackets

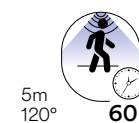

5m
120°
60"

Sensore di
movimento
regolabile /
Adjustable
motion sensor



on 2 LUX
off 1000 LUX

Sensore
crepuscolare /
Crepuscular
sensor

Materiale
PC e
placchette in acciaio

Colore
nikel
bianco



**Temperatura colore
selezionabile**
3000K / 4000K / 6500K



Driver
integrato

Material
PC and
steel frames

Colour
nikel
white



**Selectable color
temperature**
3000K / 4000K / 6500K



Driver
built-in

**Incasso segnapassi alloggio in cassetta di derivazione 503 o 506L con
doppia placchetta in acciaio intercambiabile nei colori nikel o bianco.**
Down light for recess box 503 or 506L with double
interchangeable steel frame in nikel or white colours.



INC-BOLT-503CCCT
8031414881543
lumen 350 lm

watt 3W
beam angle 120°



INC-BOLT-506CCCT
8031414881550
lumen 650 lm

watt 5W
beam angle 120°

**Accessori inclusi /
Included accessories**



2x
placchette /
frames



2x
staffette /
brackets

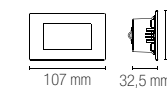

scatola derivazione 503
503 junction box
non inclusa / not included

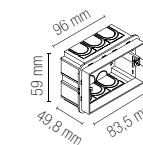

scatola derivazione 506L
506L junction box
non inclusa / not included

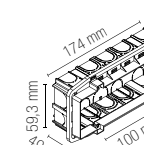

STEPLIGHT

Applique segnapassi a LED in termoplastica antracite.
Thermoplastic LED walk light anthracite finish.



technical information **STEPLIGHT**



Materiale
termoplastica

Colore
antracite goffrato



Temperatura colore
4000K



Driver
integrato

Material
thermoplastic

Colour
embossed antracite



Colour temperature
4000K



Driver
built-in



LED-STEPLIGHT 8031414882304 lumen	colour temp.  
watt	1,5W
beam angle	120°

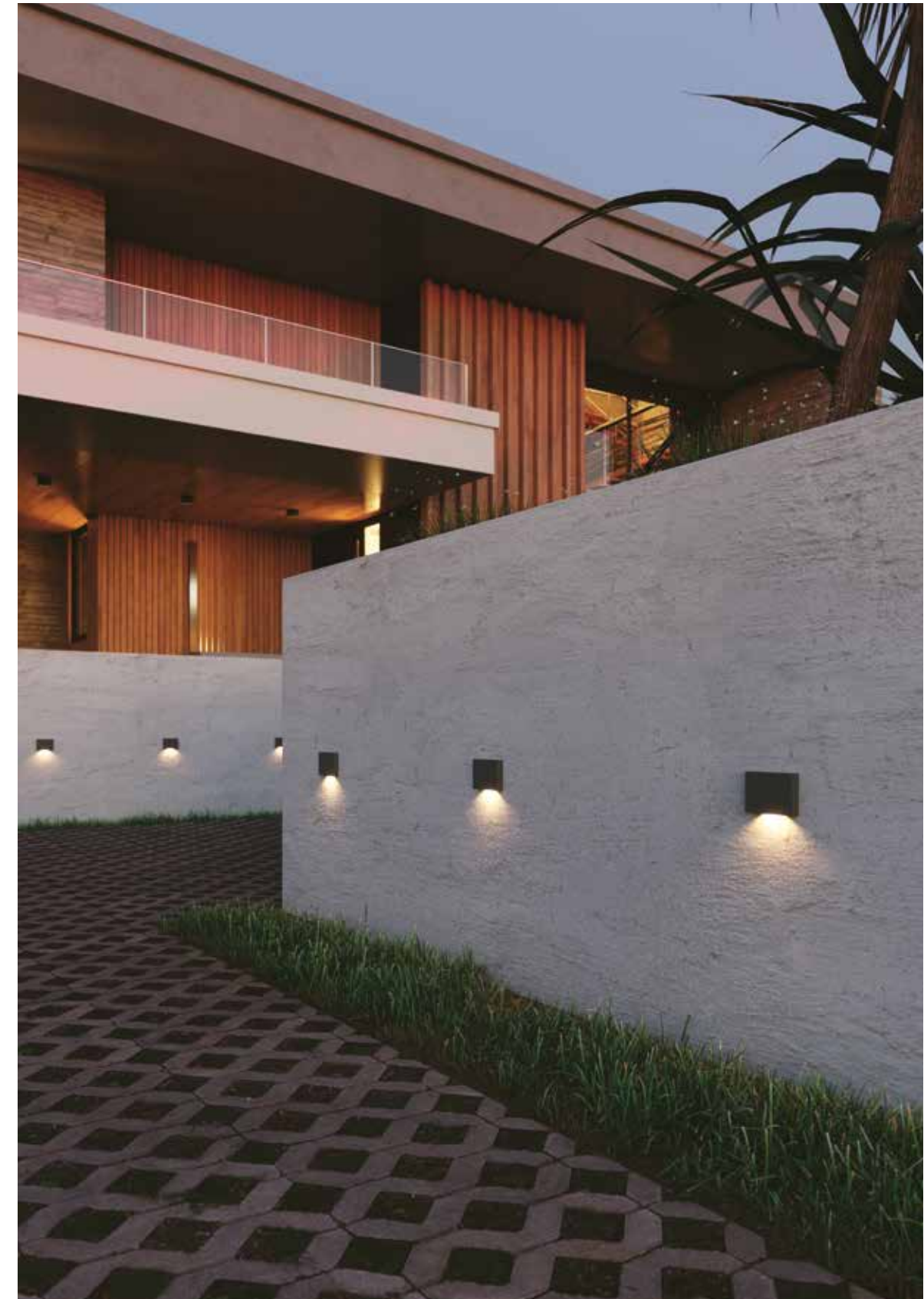
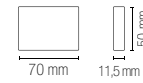

In.tec light **OUTDOOR** INCASSI E SEGNAPASSI / INGROUND AND WALK LIGHTS

SHELBY

Applique segnapassi a LED in alluminio antracite.
Aluminum LED walk light anthracite finish.

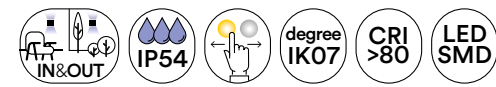
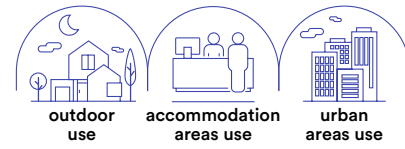

technical information **SHELBY**



Materiale
alluminio

Colore
antracite goffrato

Temperatura colore selezionabile
3000K / 4000K



Driver
integrato

Material
aluminum

Colour
embossed antracite

Selectable color temperature
3000K / 4000K



Driver
built-in



LED-W-SHELBY-130 8031440361002	colour temp.	colour
lumen	445 lm	
watt	4W	
beam angle	120°	

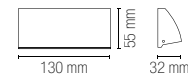

LED-W-SHELBY-170 8031440361019	colour temp.	colour
lumen	670 lm	
watt	6W	
beam angle	120°	

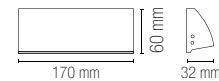

In.tec light **OUTDOOR** INCASSI E SEGNAPASSI / INGROUND AND WALK LIGHTS

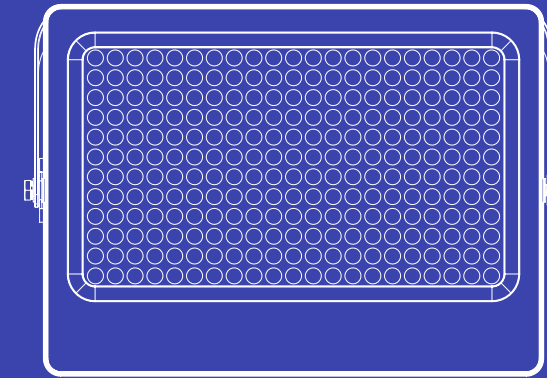

SOLARI

SOLAR LAMPS

KYOTO

Collezione in alluminio antracite con sensore e pannello solare.
Anthracite aluminum collection with sensor and solar panel.

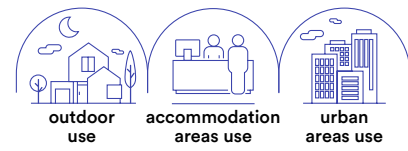

- Materiale**
alluminio
- Colore**
antracite goffrato
- Temperatura colore**
4000K
- Driver**
integrato
- Material**
aluminum
- Colour**
embossed anthracite
- Colour temperature**
4000K
- Driver**
built-in



LED-KYOTO-AP
8031414883868
lumen

colour temp. 300 lm
colour

watt 2,5W
beam angle 120°

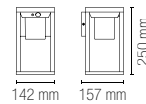

LED-KYOTO-P80
8031414883875
lumen

colour temp. 300 lm
colour

watt 2,5W
beam angle 120°



Accessori inclusi / Included accessories

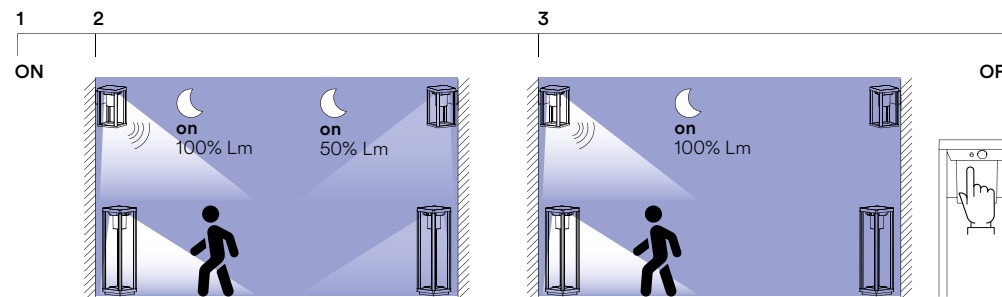
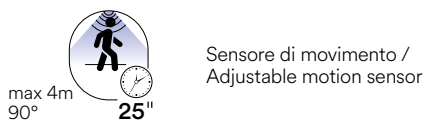

Sensore di movimento 100% luce
Dopo 25 secondi 50% luce /
Motion sensor 100% light
After 25 seconds 50% light

Sensore di movimento 100% luce
Dopo 25 secondi spegnimento luce /
Motion sensor 100% light
Light turns off after 25 seconds

ENYA

Collezione in alluminio antracite con sensore e pannello solare.
Anthracite aluminum collection with sensor and solar panel.



- Materiale**
alluminio
- Colore**
antracite goffrato
- Temperatura colore**
4000K
- Driver**
integrato
- Material**
aluminum
- Colour**
embossed anthracite
- Colour temperature**
4000K
- Driver**
built-in



LED-ENYA-AP
8031414883844
lumen

colour temp. 600 lm
colour

watt 5W
beam angle 120°

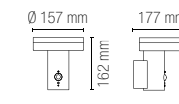

LED-ENYA-P80
8031414883851
lumen

colour temp. 600 lm
colour

watt 5W
beam angle 120°

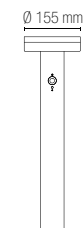

Accessori inclusi / Included accessories



Sensore di movimento 100% luce
Dopo 25 secondi 50% luce /
Motion sensor 100% light
After 25 seconds 50% light

Sensore di movimento 100% luce
Dopo 25 secondi spegnimento luce /
Motion sensor 100% light
Light turns off after 25 seconds

TED

Applique LED in alluminio antracite con sensore e pannello solare.
Aluminum LED wall light anthracite finish with sensor and solar panel.

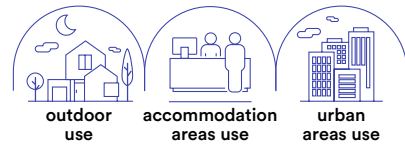

- Materiale**
alluminio
- Colore**
antracite
- Temperatura colore**
4000K
- Driver**
integrato
- Material**
aluminum
- Colour**
anthracite
- Colour temperature**
4000K
- Driver**
built-in



LED-TED-AP
8031414883837
lumen

colour temp.	colour
3000K	300 lm

watt	3W
beam angle	120°

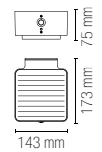

Accessori inclusi / Included accessories

- Pannello solare / Solar panel
- Li-ion 3,7V 2200 mAh**
Batteria non sostituibile /
Battery non replaceable
- Sensore di movimento /
Adjustable motion sensor
max 4m
90°
25"

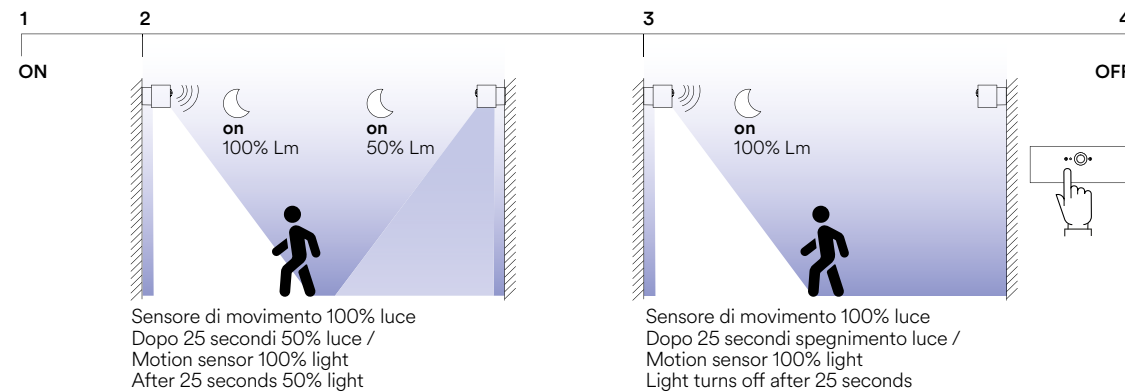

ALBERT

Applique LED in alluminio antracite con sensore e pannello solare.
Aluminum LED wall light anthracite finish with sensor and solar panel.



- Materiale**
alluminio
- Colore**
antracite
- Temperatura colore**
4000K
- Driver**
integrato
- Material**
aluminum
- Colour**
anthracite
- Colour temperature**
4000K
- Driver**
built-in



LED-ALBERT-AP
8031414058716
lumen

colour temp.	colour
3000K	300 lm

watt	2,5W
beam angle	120°

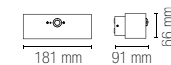

Accessori inclusi / Included accessories

- Pannello solare / Solar panel
- Li-ion 3,7V 2000 mAh**
Batteria non sostituibile /
Battery non replaceable
- Sensore di movimento /
Adjustable motion sensor
max 4m
90°
25"

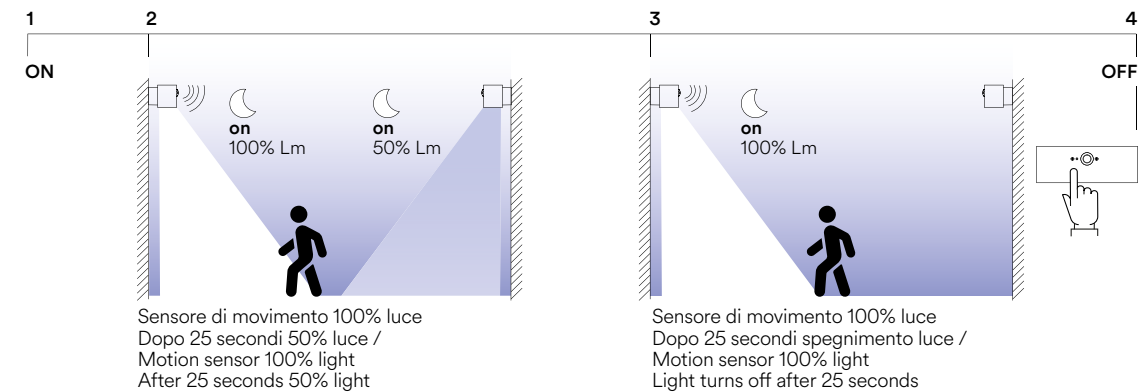

COSMO

Proiettore a batteria in termoplastica nero con sensore di movimento regolabile.
Flood light with battery power in black thermoplastic with adjustable motion sensor.



Materiale
termoplastica

Temperatura colore
6500K



Driver
integrato

Material
thermoplastic

Colour temperature
6500K



Driver
built-in



LED-COSMO/S
8031439841263
lumen

colour temp.	colour
80 lm	

watt	1W
beam angle	120°



Accessori inclusi / Included accessories

	off 10 LUX	Sensore di movimento regolabile / Adjustable motion sensor
	on 2000 LUX	

Accessori non inclusi / Not included accessories

	3 × 1,2V AAA Batteria / Battery
--	---



COSMO

Proiettore in termoplastica nero con pannello solare e sensore di movimento.
Black thermoplastic flood light with solar panel and motion sensor.



Materiale
termoplastica

Temperatura colore
6500K



Driver
integrato

Material
thermoplastic

Colour temperature
6500K



Driver
built-in



LED-COSMO/S-FV
8031439821265
lumen

colour temp.	colour
80 lm	

watt	1W
beam angle	120°

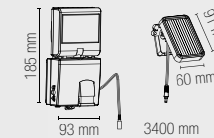

Accessori inclusi / Included accessories

	Pannello solare / Solar panel
--	----------------------------------

	Li-ion 3,7V 1200 mAh Batteria non sostituibile / Battery non replaceable /
--	---

	off 10 LUX	Sensore di movimento regolabile, accensione con 15 lux / Adjustable motion sensor, switch on 15 lux
	on 2000 LUX	

	Cavo 3,4 m / 3,4 m cable
--	-----------------------------



ELIOS

Proiettore in alluminio silver con pannello solare e sensore di movimento regolabile.
Silver aluminium flood light with solar panel and adjustable motion sensor.



Materiale
alluminio

Colore
antracite

Temperatura colore
5000K

Driver
integrato

Material
aluminium

Colour
anthracite

Colour temperature
5000K

Driver
built-in

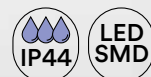

LED-ELIOS-SOLAR
8031440355124
lumen

colour temp.	colour
6200 K	Black

watt 9W
beam angle 120°

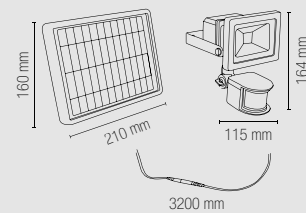

Accessori inclusi / Included accessories

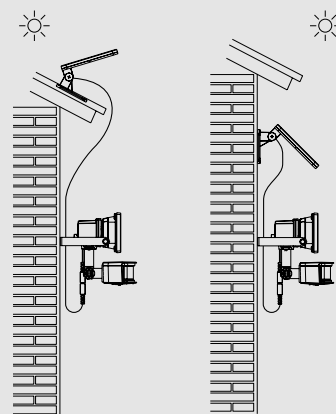
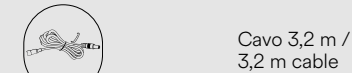
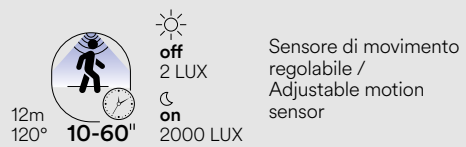
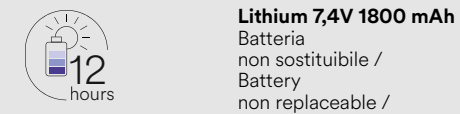
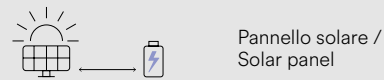

EOS

Proiettore in termoplastica silver con pannello solare, sensore di movimento e crepuscolare.
Silver thermoplastic flood light with solar panel, motion and crepuscular sensor.



Materiale
termoplastica

Colore
silver

Temperatura colore
4000K

Driver
integrato

Material
thermoplastic

Colour
silver

Colour temperature
4000K

Driver
built-in



LED-EOS-SOLAR
8031414862740
lumen

colour temp.	colour
4000 K	Black

watt 4W
beam angle 100°

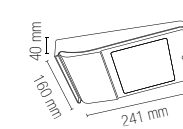

Accessori inclusi / Included accessories

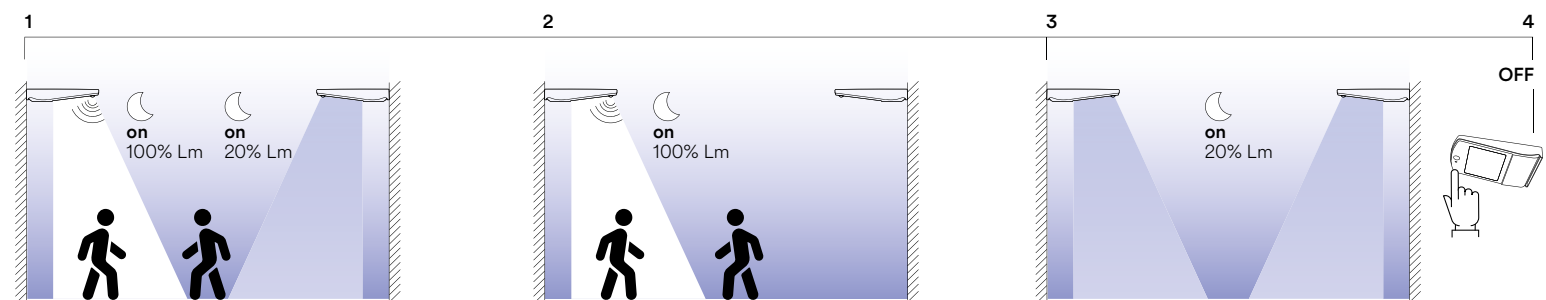
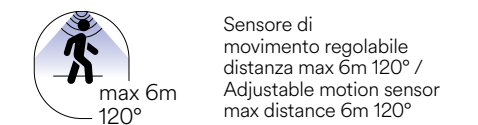

Sensore di movimento 100% luce
Sensore crepuscolare 20% luce / Motion sensor 100% light.
Crepuscular sensor 20% light

Sensore di movimento 100% luce
No sensore crepuscolare / Motion sensor 100% light
No crepuscular sensor

Sensore crepuscolare 20% luce
No sensore movimento / Crepuscular sensor 20% light
No motion sensor

OPEN

Applique LED in termoplastica bianco con sensore e pannello solare.
Thermoplastic LED wall light white finish with sensor and solar panel.



Materiale
termoplastica

Temperatura colore
4000K



Driver
integrato

Material
thermoplastic

Colour temperature
4000K



Driver
built-in



LED-OPEN-AP
8031414870752
lumen

colour temp. | colour
300 lm

watt | 3W
beam angle | 120°

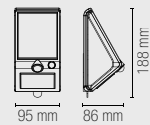

Accessori inclusi / Included accessories



Pannello solare /
Solar panel



Li-ion 1200 mAh
Batteria
non sostituibile /
Battery
non replaceable /



4-6m
100°
30"
off
15 LUX
on
<15 LUX
Sensore di
movimento regolabile,
accensione con 15 lux /
Adjustable motion sensor,
switch on 15 lux

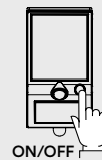

Base easy-up che permette il duplice utilizzo del
faro come lampada da muro e lampada portatile /
Easy-up base for double use of the lamp,
as wall and portable lamp

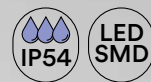

SKYP

Applique LED in termoplastica bianco con sensore e pannello solare.
Thermoplastic LED wall light white finish with sensor and solar panel.



Materiale
termoplastica

Temperatura colore
4000K



Driver
integrato

Material
thermoplastic

Colour temperature
4000K



Driver
built-in



LED-SKYP-AP
8031414870783
lumen

colour temp. | colour
130 lm

watt | 3W
beam angle | 120°

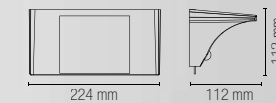

Accessori inclusi / Included accessories



Pannello solare /
Solar panel



Li-ion 3,7V 1200 mAh
Batteria
non sostituibile /
Battery
non replaceable /



4-6m
100°
30"
off
15 LUX
on
<15 LUX
Sensore di
movimento regolabile,
accensione con 15 lux /
Adjustable motion sensor,
switch on 15 lux



Base easy-up che permette il duplice utilizzo del
faro come lampada da muro e lampada portatile /
Easy-up base for double use of the lamp,
as wall and portable lamp





ARGO

Proiettore in alluminio antracite con diffusore in acrilico con pannello solare, sensore di movimento e crepuscolare.
 Anthracite aluminum flood light with acrylic diffuser, solar panel, motion and crepuscular sensor.



- Materiale**
alluminio e acrilico
- Colore**
antracite
- Temperatura colore**
4000K
- Driver**
integrato
- Material**
aluminum and acrylic
- Colour**
anthracite
- Colour temperature**
4000K
- Driver**
built-in



	colour temp.	colour
LED-ARGO-SOLAR 8031414865345 lumen		
	130 lm	
watt	1,8W	
beam angle	120°	
	250 mm	178 mm
		200 mm

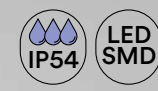

Accessori inclusi / Included accessories	
	Pannello solare / Solar panel
	Li-ion 3,7V 2200 mAh Batteria non sostituibile / Battery non replaceable
	Sensore di movimento / Motion sensor 5m 100° on 130Lm 1,5 hours 30"
	Sensore crepuscolare / Crepuscular sensor off on 26 Lm 8 horas

SOLARI / SOLAR LAMPS
In.tec light

SHIVA

Proiettore in termoplastica antracite con pannello solare e sensore di movimento.
Anthracite thermoplastic flood light with solar panel and motion sensor.

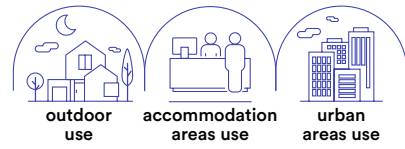

Materiale
termoplastica

Colore
antracite

Temperatura colore
4000K

Driver
integrato

Material
aluminum and acrylic

Colour
anthracite

Colour temperature
4000K

Driver
built-in



LED-SHIVA-SOLAR
8031414870769
lumen

colour temp. | colour
230 lm

watt | 2 x 1,5W
beam angle | 120°

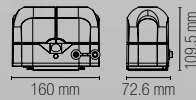

Accessori inclusi / Included accessories

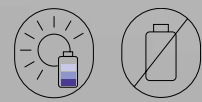
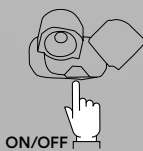
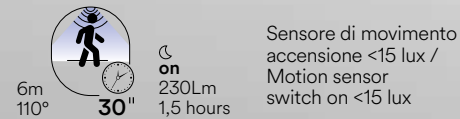
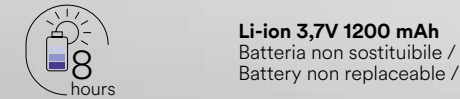

3 x 1,2V AAA
non inclusa / not included

Doppia funzione: auto-ricarica con pannello solare o alimentazione con pile AAA (non incluse) / **Double function:** auto recharge by solar panel or power by AAA battery (not included)

ULYSSE

Proiettore in termoplastica antracite con pannello solare e sensore di movimento regolabile.
Anthracite thermoplastic flood light with solar panel and adjustable motion sensor.

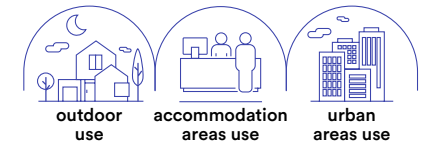

Materiale
termoplastica

Colore
antracite

Temperatura colore
4000K

Driver
integrato

Material
thermoplastic

Colour
anthracite

Colour temperature
4000K

Driver
built-in



LED-ULYSSE-SOLAR
8031414882588
lumen

colour temp. | colour
1000 lm

watt | 10W
beam angle | 120°

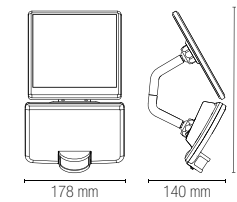

Accessori inclusi / Included accessories

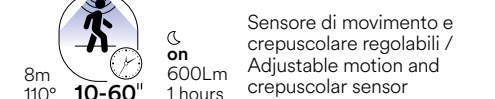
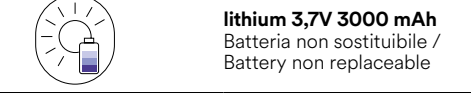
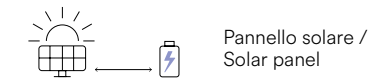

Doppio sistema di montaggio / Double mounting system

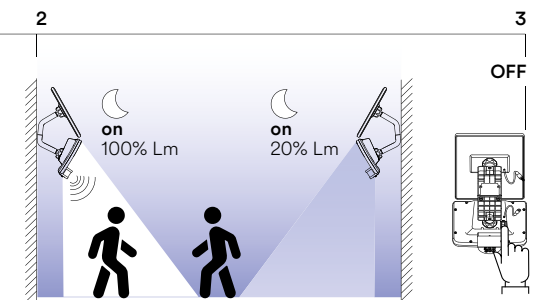
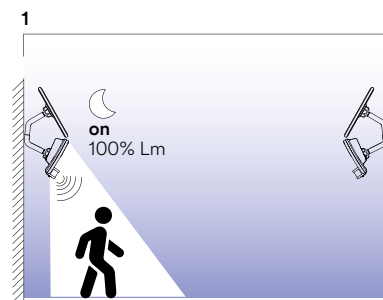
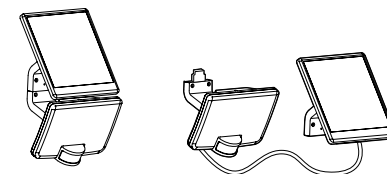

ATHOS SOLAR

Proiettore in alluminio silver con pannello solare.
Silver aluminum flood light with solar panel.



Materiale
alluminio

Material
aluminum

Colore
silver

Colour
silver

Temperatura colore
4000K

Colour temperature
4000K

Driver
integrato

Driver
built-in



technical information **ATHOS**



LED-ATHOS-SOL100

8031414884247
lumen

colour temp. colour
1400 lm

watt 100W
beam angle 80°

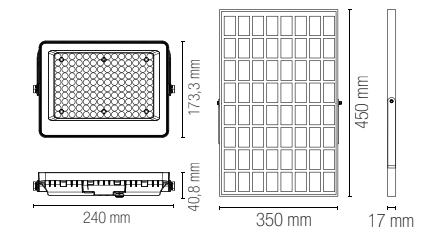

LED-ATHOS-SOL200

8031414884254
lumen

colour temp. colour
2900 lm

watt 200W
beam angle 80°

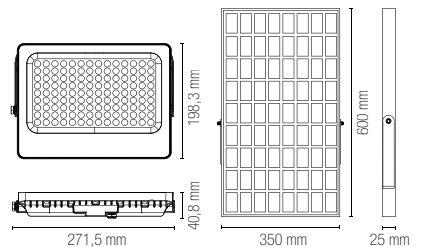

LED-ATHOS-SOL300

8031414884261
lumen

colour temp. colour
4800 lm

watt 300W
beam angle 80°

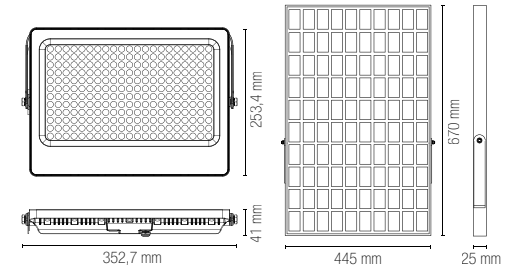

**Accessorio non incluso /
Not included accessory**

LED-ATHOS-CABLE
8031414886975

Cavo 2 m per pannello solare
con attacco maschio/femmina
2 m extension cable for solar
panel with male/female extend

**Accessori inclusi /
Included accessories**

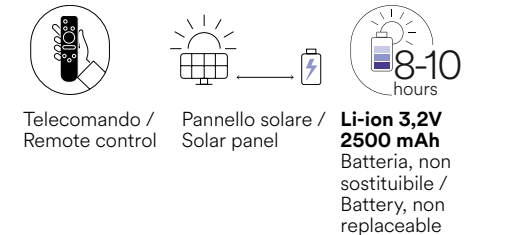

Telecomando /
Remote control

Pannello solare /
Solar panel

**Li-ion 3,2V
2500 mAh**
Batteria, non
sostituibile /
Battery, non
replaceable

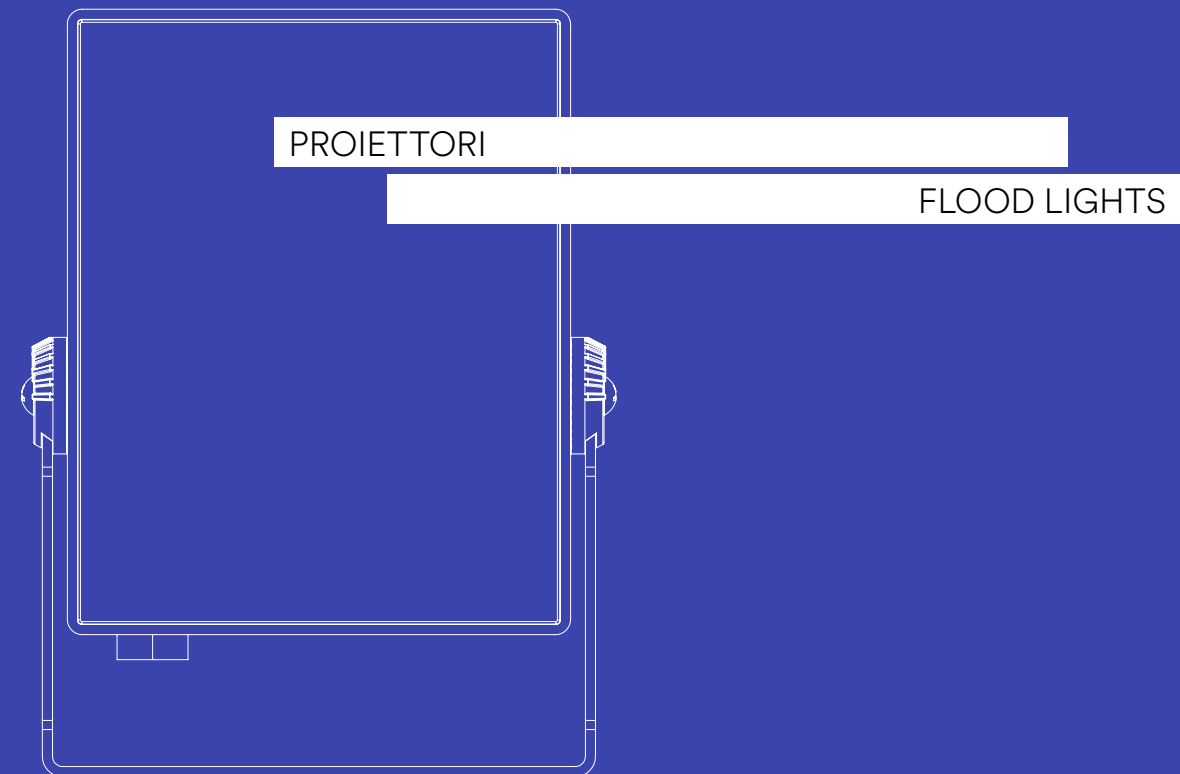

Proiettore con telecamera di sicurezza colore antracite con funzione smart Wi-Fi, compatibili con dispositivi iOS, android e VOICE CONTROL.

Flood light with security camera, anthracite, smart Wi-Fi, compatible with iOS devices, android and VOICE CONTROL devices.

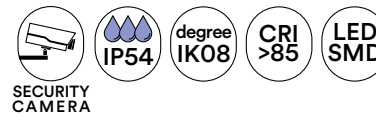
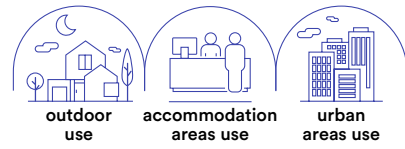

technical information **VYSOR**



Materiale
alluminio + PC

Colore
antracite



Temperatura colore
4000K



Driver
integrato

Material
aluminium + PC

Colour
anthracite



Colour temperature
4000K



Driver
built-in



LED-VYSOR-SECURITY 8031414871810	colour temp. <input type="radio"/>	colour <input type="radio"/>
lumen	2640 lm	
watt	20W	
beam angle	120°	

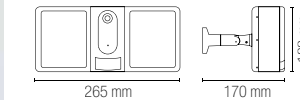

Tipo di sensore video Video sensor type	1/2,9" CMOS
Pixel	2.0 Mega
Illuminazione minima Min illuminance	Color 0.10lux @F2.0, black and white 0.01lux @F2.0
Angolo vista camera Camera view angle	135°
Otturatore Shutter	1/25-1/100,000 per second
Infrarossi IR	High power LED with ICR
WDR	Digital WDR
Video compression standard	H.264 32Kbps - 2Mbps
Risoluzione video Max picture size	1920x1080
Frequenza fotogrammi Frame rate	1-20 per second
Audio	Full duplex audio (doppio sistema di comunicazione)
Memoria (non inclusa) Storage (not included)	Support SD card (MAX 128Gb) Cloud storage NVR
Impostazione immagine Image setting	Support HD/SD; support mirror
Reset	Support
Controllo della luce Lighting control	Support manual, sensor, plan switch light (gestione accensioni)
Interfaccia di protocollo Interface protocol	Private
Comunicazione di protocollo Communication protocol	TCP/IP, HTTP, DHCP, DNS, RTSP
Funzioni generali General function	Dual stream, password protection
Wi-Fi	IEEE802.11b/g/n
PIR	Support PIR and motion detection

on <100 LUX PIR
off >100 LUX PIR

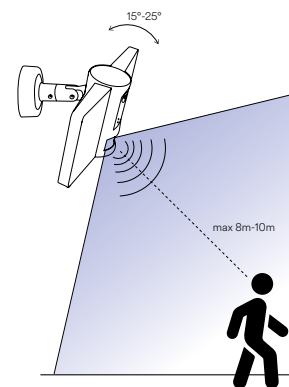
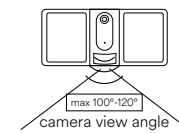

Control system easy installation

Full duplex audio

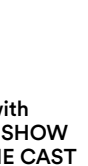

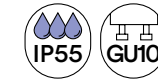

Materiale
metallo

Colore
nero satinato



Material
metal

Colour
satin black



Proiettore in metallo nero satinato con struttura flessibile e punto luce orientabile.

Black satin metal projector with flexible structure and adjustable light point.

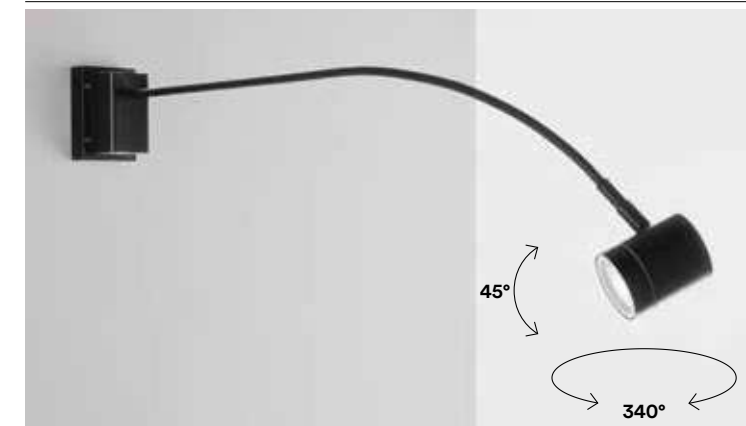

colour 
I-BANNER-AP
8031414883004
1 x GU10 MAX 35W

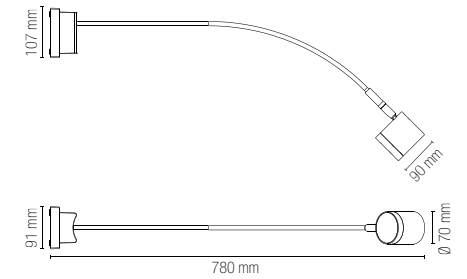

SAT

Proiettore in termoplastica LED integrato finitura antracite con diffusore in acrilico con sensore di movimento e crepuscolare regolabile.

Built-in LED thermoplastic flood lamp anthracite finish with acrylic diffuser with adjustable night and motion sensor.

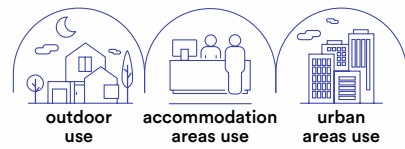

technical information **SAT**



Materiale
termoplastica

Colore
antracite

Temperatura colore
4000K

Driver
integrato

Material
thermoplastic

Colour
anthracite

Colour temperature
4000K

Driver
included



LED-SAT-10
8031414868261
lumen

colour temp.	colour
1200 lm	

watt 10W
beam angle 120°

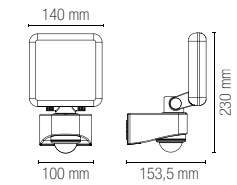

Accessori inclusi / Included accessories

Sensore di movimento regolabile / Adjustable motion sensor

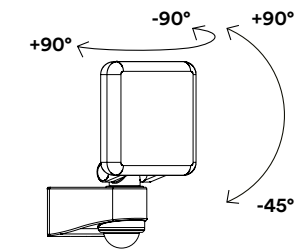

LED-SAT-20
8031414868278
lumen

colour temp.	colour
2400 lm	

watt 2 x 10W
beam angle 120°

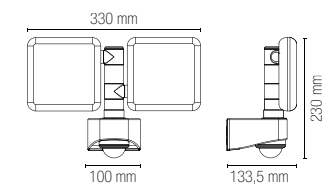

Accessori inclusi / Included accessories

Sensore di movimento regolabile / Adjustable motion sensor

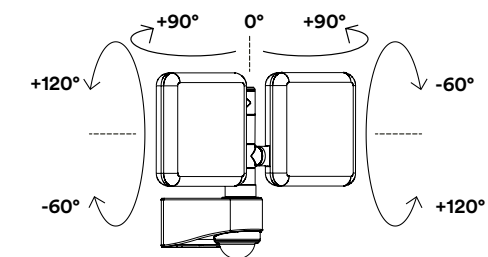
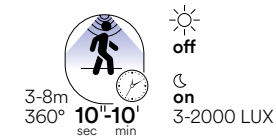

KRONOS

Proiettore in alluminio LED integrato finitura bianco goffrato.
Built-in LED aluminium flood lamp embossed white finish.



technical information **KRONOS**



Materiale
alluminio
diffusore acrilico

Colore
bianco
goffrato

Temperatura colore
4000K

Driver
integrato

Material
aluminium
acrylic diffuser

Colour
embossed
white

Colour temperature
4000K

Driver
built-in



LED-KRONOS/10W

8031436031230
lumen

colour temp.	colour
800 lm	

watt	10W
beam angle	120°
pf	-

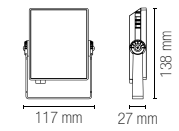

LED-KRONOS/20W

8031436001233
lumen

colour temp.	colour
1300 lm	

watt	20W
beam angle	120°
pf	-

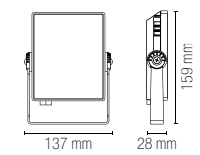

LED-KRONOS/50W

8031436011232
lumen

colour temp.	colour
3400 lm	

watt	50W
beam angle	120°
pf	0.90

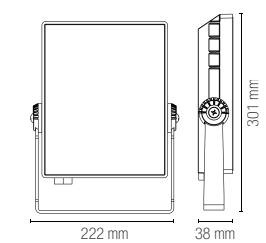

LED-KRONOS/100W

8031414018932
lumen

colour temp.	colour
8000 lm	

watt	100W
beam angle	120°
pf	0.90

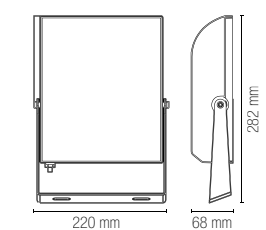

Fotometria del prodotto / Photometric curve

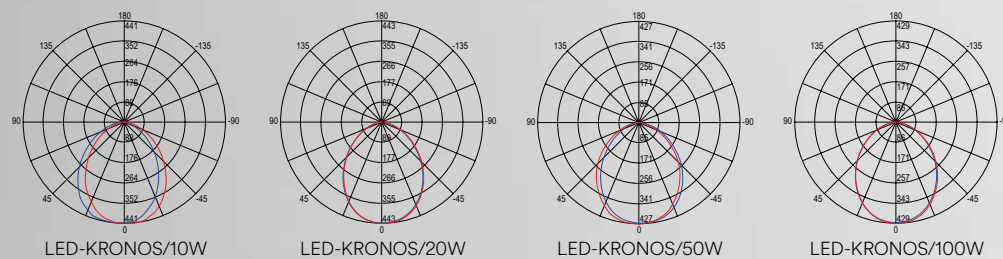

ELIOS

Proiettore in alluminio LED integrato finitura silver.
Built-in LED aluminium flood lamp embossed silver finish.



technical information **ELIOS**



Materiale
alluminio
diffusore acrilico

Colore
silver
gofrato

Temperatura colore
4000K

Driver
integrato

Material
aluminium
acrylic diffuser

Colour
embossed
silver

Colour temperature
4000K

Driver
built-in



Fotometria del prodotto / Photometric curve

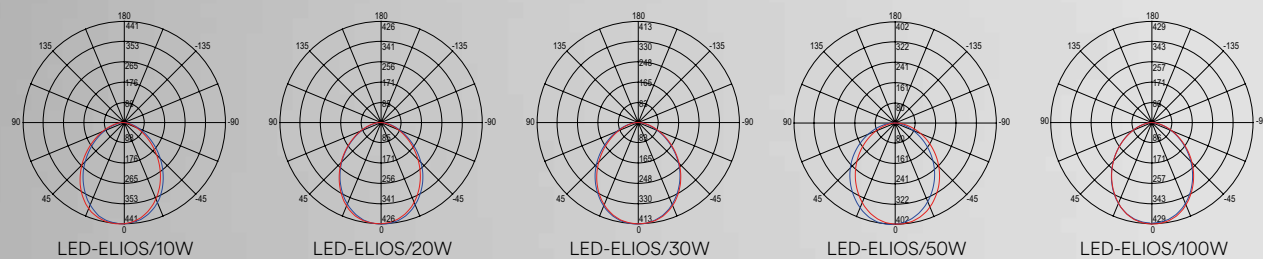

LED-ELIOS/10W

8031431291189
lumen

colour temp.	colour
●	●
800 lm	

watt	10
beam angle	120°
pf	-

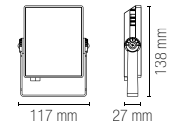

LED-ELIOS/20W

8031431281180
lumen

colour temp.	colour
●	●
1300 lm	

watt	20W
beam angle	120°
pf	-

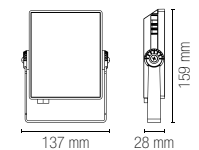

LED-ELIOS/30W

8031437391241
lumen

colour temp.	colour
●	●
2000 lm	

watt	30W
beam angle	120°
pf	0.90

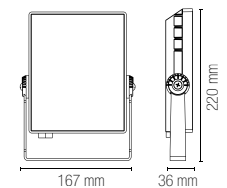

LED-ELIOS/50W

8031432091191
lumen

colour temp.	colour
●	●
3400 lm	

watt	50W
beam angle	120°
pf	0.90

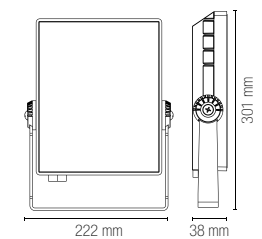

LED-ELIOS/100W

8031440357159
lumen

colour temp.	colour
●	●
8000 lm	

watt	100W
beam angle	120°
pf	0.90

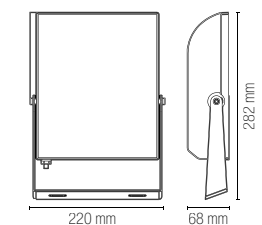

ELIOS

Proiettore in alluminio LED integrato finitura silver con sensore di movimento e crepuscolare regolabile.

Built-in LED aluminium flood lamp embossed silver finish with adjustable night and motion sensor.

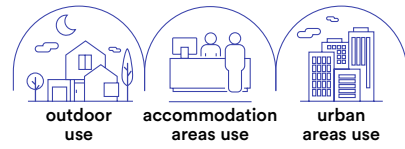

- Materiale**
alluminio
- Colore**
antracite
- Temperatura colore**
4000K
- Driver**
integrato
- Material**
aluminium
- Colour**
anthracite
- Colour temperature**
4000K
- Driver**
built-in



Accessori inclusi / Accessories included

Sensore di movimento regolabile / Adjustable motion sensor



LED-ELIOS-S/10W 8031437381242

lumen

colour temp. colour
800 lm

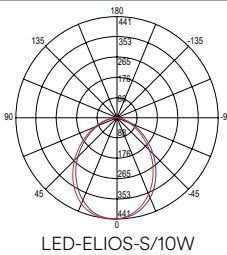
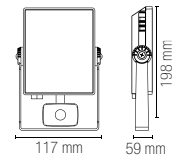

watt 10W
beam angle 120°

Accessori inclusi / Accessories included

Sensore di movimento regolabile / Adjustable motion sensor

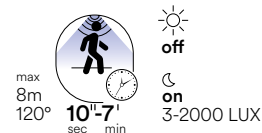

LED-ELIOS-S/30W 8031436391235

lumen

colour temp. colour
2000 lm

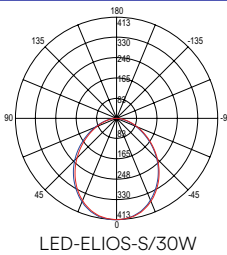
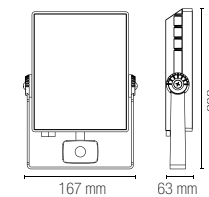

watt 30W
beam angle 120°

ELIOS

Proiettore LED portatile.
LED portable flood light.



- Materiale**
alluminio
- Colore**
nero
- Temperatura colore**
4000K
- Driver**
integrato
- Material**
aluminium
- Colour**
black
- Colour temperature**
4000K
- Driver**
built-in



Accessori inclusi / Included accessories

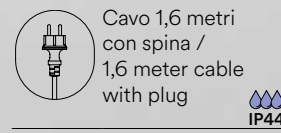

LED-ELIOS-P/20W 8031436381236

lumen

colour temp. colour
1300 lm

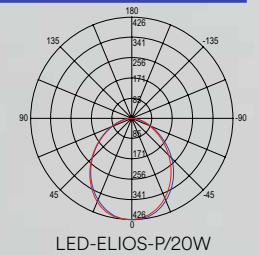
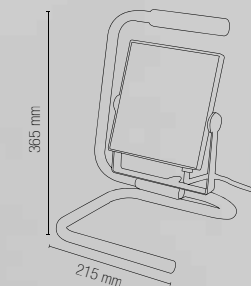

watt 20W
beam angle 120°

ATHOS

Proiettore a led integrato in alluminio silver e diffusore satinato.
Built-in LED aluminium flood lamp silver finish with satin diffuser.



technical information **ATHOS**



- Materiale**
alluminio
- Colore**
silver
- Temperatura colore**
4000K / 6000K
- Driver**
integrato
- Material**
aluminium
- Colour**
silver
- Colour temperature**
4000K / 6000K
- Driver**
built-in



	colour temp.	colour
LED-ATHOS-100 8031414884186		
lumen	10115 lm	
LED-ATHOS-100F 8031414884193		
lumen	9624 lm	
watt	100W	
beam angle	90°	
pf	0.90	

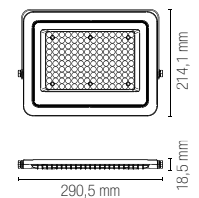

	colour temp.	colour
LED-ATHOS-150 8031414884209		
lumen	14557 lm	
LED-ATHOS-150F 8031414884216		
lumen	14388 lm	
watt	150W	
beam angle	90°	
pf	0.90	

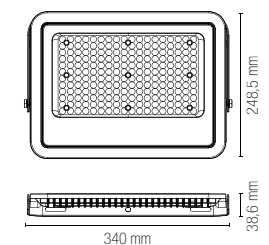

	colour temp.	colour
LED-ATHOS-200 8031414884223		
lumen	20371 lm	
LED-ATHOS-200F 8031414884230		
lumen	20310 lm	
watt	300W	
beam angle	90°	
pf	0.90	

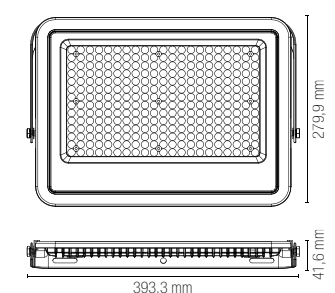

Fotometria del prodotto / Photometric curve

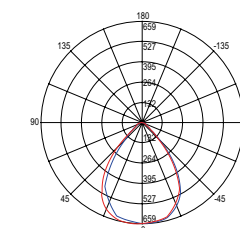

LED-ATHOS-100

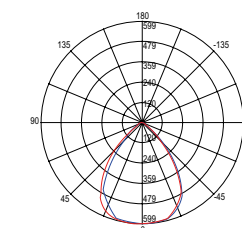

LED-ATHOS-150

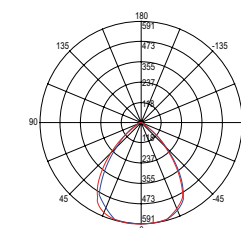

LED-ATHOS-200

PLUTONE

Proiettore a led integrato in alluminio antracite e diffusore in acrilico bianco.
Built-in LED aluminium flood lamp anthracite finish with acrylic white diffuser.



technical information **PLUTONE**



Materiale
alluminio
diffusore in acrilico

Colore
antracite

Temperatura colore
3000K / 4000K / 6500K



Driver
integrato

Material
aluminium
acrylic diffuser

Colour
anthracite

Colour temperature
3000K / 4000K / 6500K



Driver
built-in



Fotometria del prodotto / Photometric curve

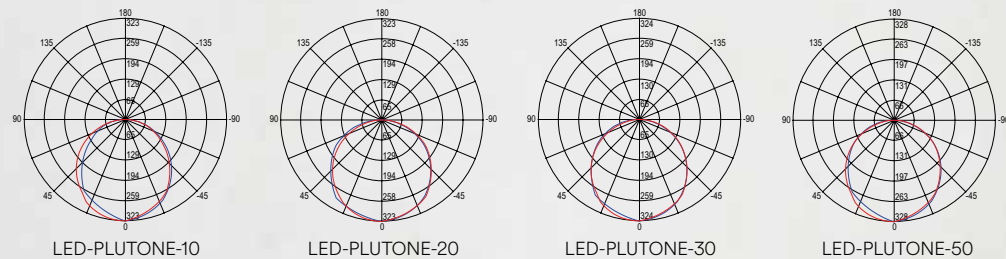

LED-PLUTONE-10 8031414875887	colour temp.	colour
	● ●	● ●
lumen	800 lm	
watt	10W	
beam angle	120°	
pf	-	

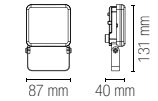

LED-PLUTONE-20C 8031414876099	colour temp.	colour
	● ●	● ●
lumen	1600 lm	
LED-PLUTONE-20 8031414875894	colour temp.	colour
	● ●	● ●
lumen	1600 lm	
LED-PLUTONE-20F 8031414876112	colour temp.	colour
	● ●	● ●
lumen	1600 lm	
watt	20W	
beam angle	120°	
pf	-	

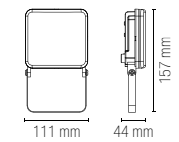

LED-PLUTONE-30 8031414875900	colour temp.	colour
	● ●	● ●
lumen	2400 lm	
watt	30W	
beam angle	120°	
pf	0.90	

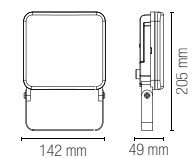

LED-PLUTONE-50C 8031414879144	colour temp.	colour
	● ●	● ●
lumen	4000 lm	
LED-PLUTONE-50 8031414875917	colour temp.	colour
	● ●	● ●
lumen	4000 lm	
LED-PLUTONE-50F 8031414879120	colour temp.	colour
	● ●	● ●
lumen	4000 lm	
watt	50W	
beam angle	120°	
pf	0.90	

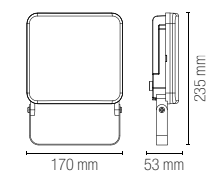

PLUTONE

Proiettore a LED integrato in alluminio antracite e diffusore in acrilico bianco con sensore di movimento e crepuscolare regolabile.

Built-in LED aluminum flood lamp anthracite finish with acrylic white diffuser with adjustable night and motion sensor.

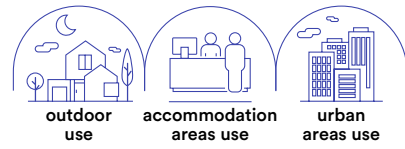

- Materiale**
alluminio
diffusore in acrilico
- Colore**
antracite
- Temperatura colore**
4000K
- Driver**
integrato
- Material**
aluminium
acrylic diffuser
- Colour**
anthracite
- Colour temperature**
4000K
- Driver**
built-in

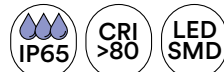

Accessori inclusi / Accessories included

Sensore di movimento regolabile / Adjustable motion sensor

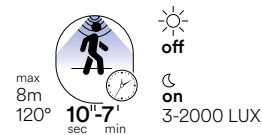

LED-PLUTONE-S20
8031414875924
lumen

colour temp. colour
1600 lm

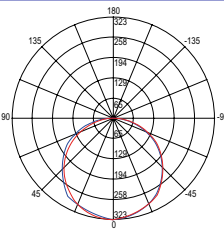

watt 20W
beam angle 120°

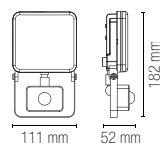

Accessori inclusi / Accessories included

Sensore di movimento regolabile / Adjustable motion sensor

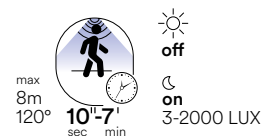

LED-PLUTONE-S50
8031414875931
lumen

colour temp. colour
4000 lm

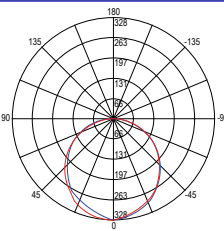

watt 50W
beam angle 120°

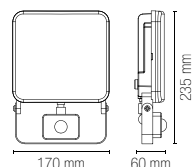

PLUTONE

Proiettore LED portatile.
LED portable flood light.



- Materiale**
alluminio
- Colore**
antracite
- Temperatura colore**
4000K
- Driver**
integrato
- Material**
aluminium
- Colour**
anthracite
- Colour temperature**
4000K
- Driver**
built-in



Accessori inclusi / Included accessories

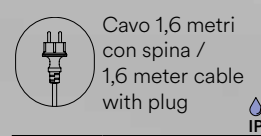

LED-PLUTONE-P20
8031414875948
lumen

colour temp. colour
1600 lm

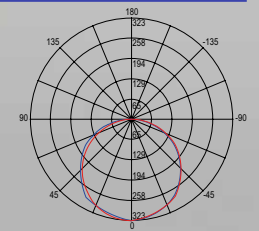

watt 20W
beam angle 120°

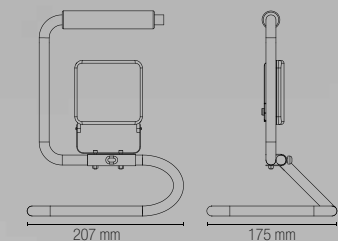

PROIETTORI / FLOOD LIGHTS
In.tec light

TAURUS

Proiettore a led integrato in alluminio nero diffusore in vetro temperato.
Built-in LED aluminium flood lamp black aluminium body with tempered glass diffuser.



technical information **TAURUS**



- Materiale**
alluminio
- Colore**
nero
- Temperatura colore**
4000K / 6500K
- Driver**
integrato
- Durata e on/off**
50.000 h
>25.000 on/off
- Material**
aluminium
- Colour**
black
- Colour temperature**
4000K / 6500K
- Driver**
built-in
- Life time and on/off**
50.000 h
>25.000 on/off



Fotometria del prodotto / Photometric curve

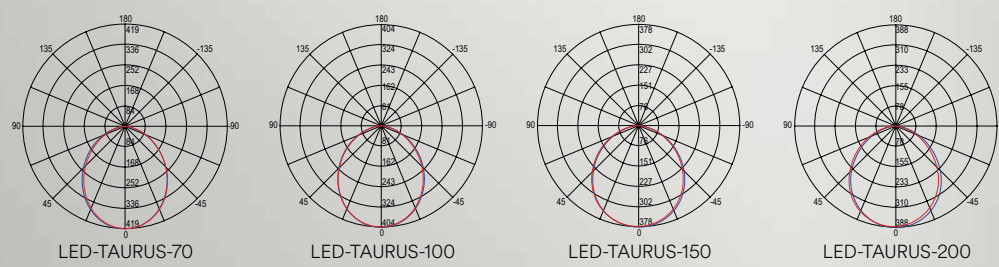

ModelPart Number	lumens	watt	beam angle	colour temp.	colour	Dimensions (mm)
LED-TAURUS-70 8031414875757	8400 lm	70W	110°	● (white)	● (black)	229mm x 48mm x 249mm
LED-TAURUS-70F 8031414876662	8400 lm			● (blue)	● (black)	
LED-TAURUS-100 8031414875764	12000 lm	100W	110°	● (white)	● (black)	272mm x 60mm x 315mm
LED-TAURUS-100F 8031414876631	12000 lm			● (blue)	● (black)	
LED-TAURUS-150 8031414875771	18000 lm	150W	110°	● (white)	● (black)	297mm x 60mm x 351mm
LED-TAURUS-150F 8031414876648	18000 lm			● (blue)	● (black)	
LED-TAURUS-200 8031414875788	26000 lm	200W	110°	● (white)	● (black)	347mm x 59,5mm x 408mm
LED-TAURUS-200F 8031414876655	26000 lm			● (blue)	● (black)	



I-FRAME-L-BCO
8031440364577

Staffa fissaggio angolare
colore bianco

Metal corner wall
arms white color



I-FRAME-L-GR
8031440361880

Staffa fissaggio angolare
colore grigio

Metal corner wall
arms gray color



I-FRAME-V-BCO
8031440364553

Staffa V mobile 30°
fissaggio parete
colore bianco

Metal wall arms
orientable 30°
white color



I-FRAME-V-GR
8031440364584

Staffa V mobile 30°
fissaggio parete
colore grigio

Metal wall arms
orientable 30°
gray color



I-TRIPOD

8031440361729

Accessori per proiettori
Sistema di fissaggio
singolo e doppio

Flood light accessories
Single and double
connection system



**Accessori inclusi /
Included accessories**



Cavo 1,6 metri
con spina /
1,6 meter cable
with plug

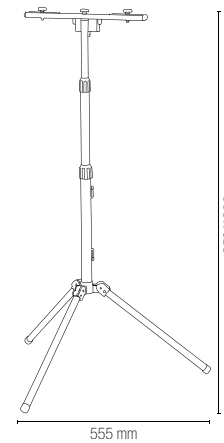

I-SPIKE-ANT
8031414877973

Picchetto alluminio
antracite

Anthracite aluminum
spike

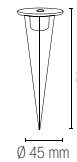

SENSORI / SENSORS

Sensori adattabili a qualsiasi prodotto illuminotecnico
Sensors compatible for any lighting products



I-SENSORE-360
8031435901237

Sensore PIR 230V
max 1600W 360°
distanza massima 5m.
time 10 sec. - 4 min.
lux 2 - 2000

PIR sensor 230V
max 1600W 360°
max 5m.
time 10 sec. - 4 min.
lux 2 - 2000

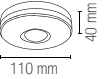

I-SENSORE-130
8031434401219

Sensore PIR 230V
max 1000W 130°
distanza massima 12m.
time 10 sec. - 4 min.
lux 2 - 2000
base accessoria angolare

PIR sensor 230V
max 1000W 130°
max 12m.
time 10 sec. - 4 min.
lux 2 - 2000
corner accessory base

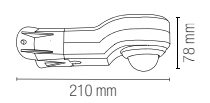

I-SENSORE-180
8031434411218

Sensore PIR 230V
max 1000W 180°
distanza massima 12m.
time 10 sec. - 4 min.
lux 2 - 2000

PIR sensor 230V
max 1000W 180°
max 12m.
time 10 sec. - 4 min.
lux 2 - 2000

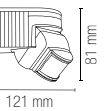

GIOVE

Proiettore LED integrato struttura in alluminio pressofuso e diffusore in vetro temperato.

Built-in LED floor light die-cast aluminium body and tempered glass diffuser.



technical information GIOVE



- Materiale**
alluminio
- Colore**
nero
- Temperatura colore**
6000K
- Driver**
incluso
- Durata e on/off**
50.000 h
>25.000 on/off
- Material**
aluminium
- Colour**
black
- Colour temperature**
6000K
- Driver**
included
- Life time and on/off**
50.000 h
>25.000 on/off



Fotometria del prodotto
Photometric curve

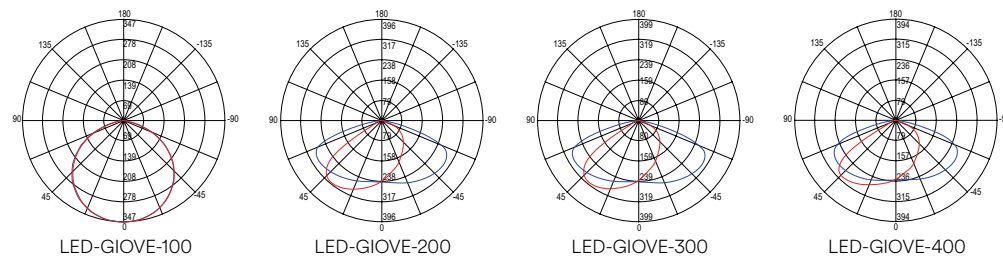

LED-GIOVE-100

8031414882557
lumen

colour temp.	beam angle	colour
6000K	150° x 80°	Black

watt 100W
pf 0.90

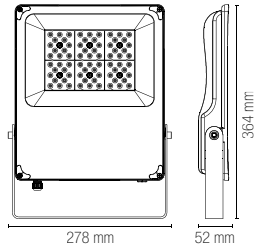

LED-GIOVE-200

8031414876365
lumen

colour temp.	beam angle	colour
6000K	150° x 80°	Black

8031414885138
lumen

colour temp.	beam angle	colour
6000K	30°	Black

8031414885145
lumen

colour temp.	beam angle	colour
6000K	60°	Black

8031414885152
lumen

colour temp.	beam angle	colour
RED	30°	Black

8031414885169
lumen

colour temp.	beam angle	colour
RED	60°	Black

8031414885176
lumen

colour temp.	beam angle	colour
GREEN	30°	Black

8031414885183
lumen

colour temp.	beam angle	colour
GREEN	60°	Black

watt 200W
pf 0.90

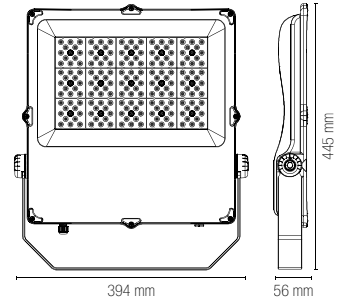

LED-GIOVE-300

8031414876372
lumen

colour temp.	beam angle	colour
6000K	150° x 80°	Black

watt 300W
pf 0.90

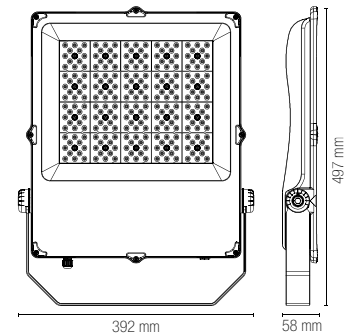

LED-GIOVE-400

8031414876389
lumen

colour temp.	beam angle	colour
6000K	150° x 80°	Black

watt 400W
pf 0.90

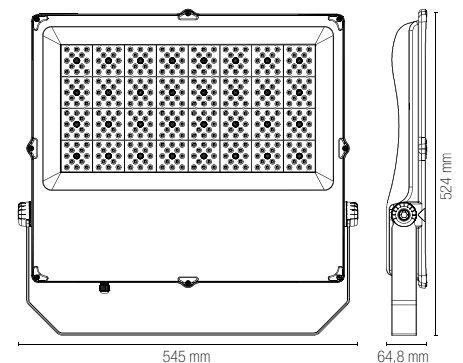

MASTER



Proiettore LED integrato struttura in alluminio pressofuso e diffusore con lenti in materiale autoestinguente, antiurto, anti-UV.
 Built-in LED floor light die-cast aluminium body and lens in anti-UV, self-extinguishing, shockproof material.

- Materiale**
alluminio
- Colore**
nero
- Temperatura colore**
5700K
- Driver**
incluso
- Durata e on/off**
50.000 h
>25.000 on/off
- Material**
aluminium
- Colour**
black
- Colour temperature**
5700K
- Driver**
included
- Life time and on/off**
50.000 h
>25.000 on/off

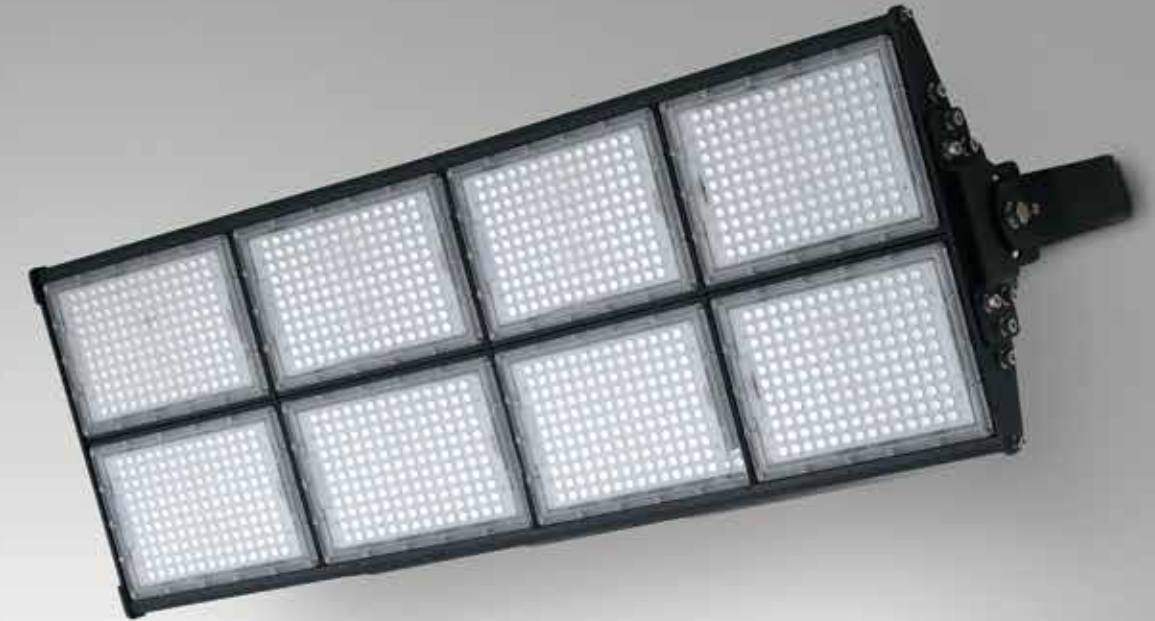

LED-MASTER-960 8031414862122	colour temp.	colour	
lumen	129600 lm		
watt	960W		LED-MASTER-960
beam angle	60° x 100°		
pf	0.90		

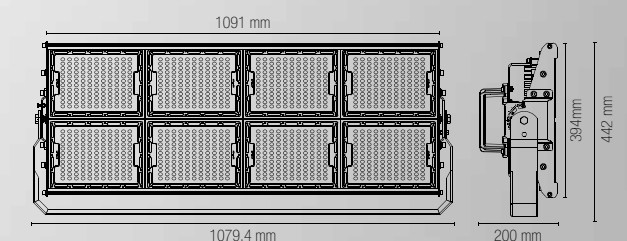

PROIETTORI / FLOOD LIGHTS

In.tec light

ENERGY

Faro LED integrato per pensiline struttura in alluminio pressofuso e diffusore con lenti in materiale autoestinguente, antiurto, anti-UV.

Gas station built-in LED light in die-cast aluminium body and lens in anti-UV, self-extinguishing, shockproof material.

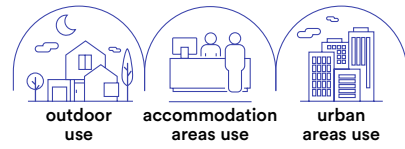

technical information **ENERGY**



- Materiale**
alluminio
- Colore**
bianco
- Temperatura colore**
4000K
- Driver**
incluso
- Durata e on/off**
50.000 h
>25.000 on/off
- Material**
aluminium
- Colour**
white
- Colour temperature**
4000K
- Driver**
included
- Life time and on/off**
50.000 h
>25.000 on/off



LED-ENERGY-80-INC 8031414862085	colour temp.	colour
lumen	1100 lm	
watt	80W	
beam angle	80°	
pf	0.90	

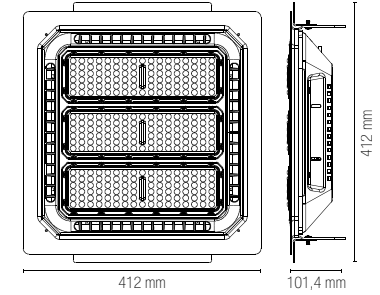

LED-ENERGY-80-PL 8031414862078	colour temp.	colour
lumen	1100 lm	
watt	80W	
beam angle	80°	
pf	0.90	

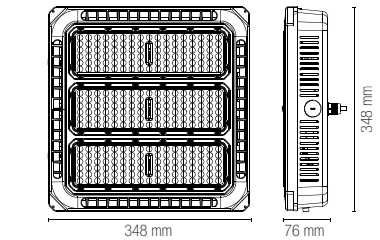

Fotometria del prodotto / Photometric curve

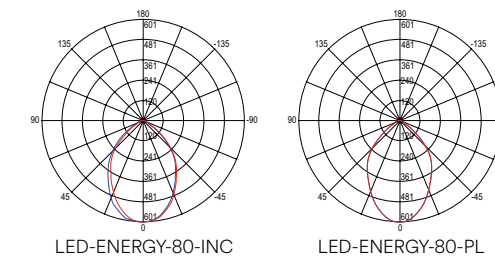

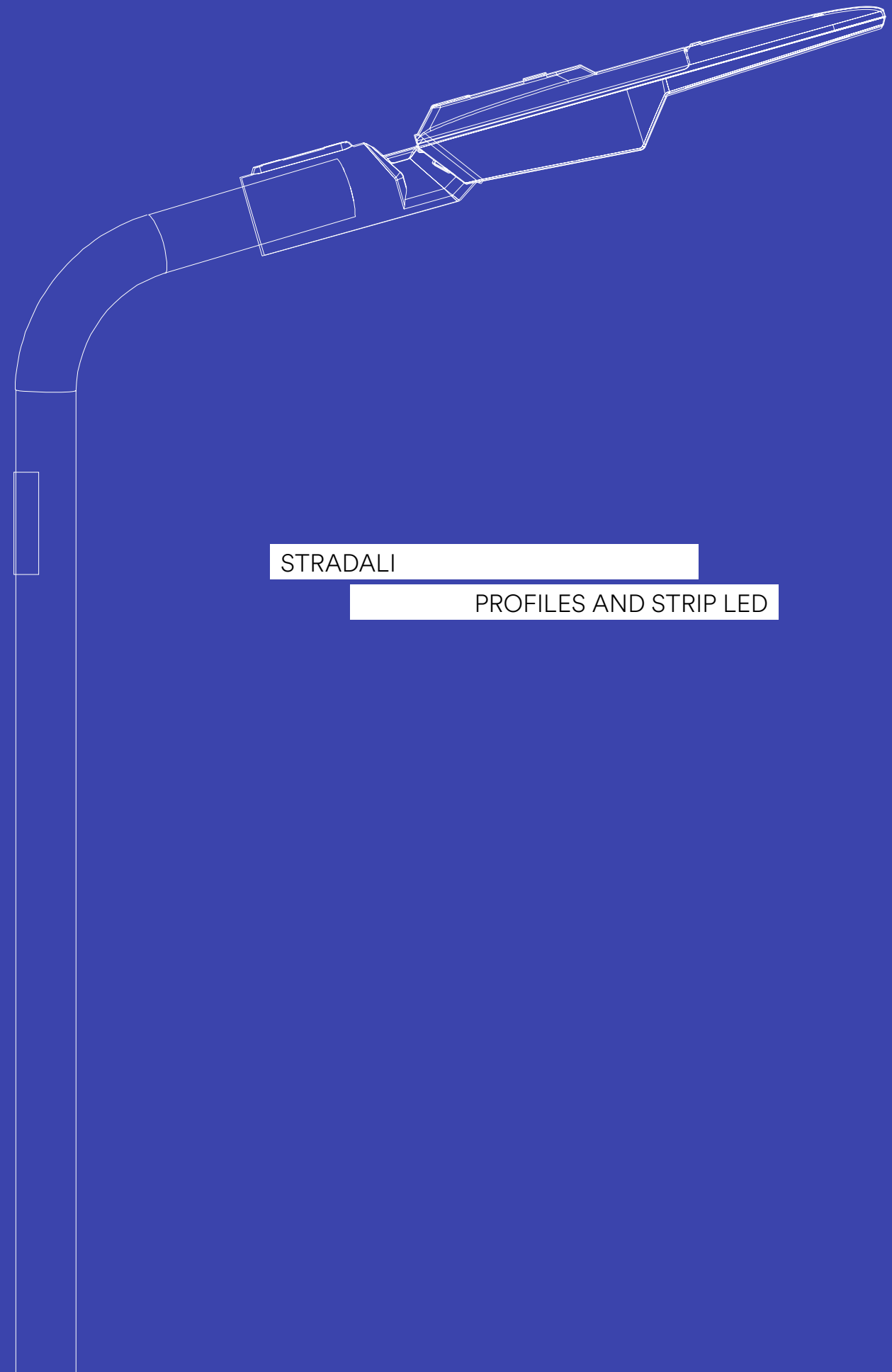

STRADALI

PROFILES AND STRIP LED

INVICTUS

Faro stradale LED in alluminio silver con pannello solare, diffusore con lenti in materiale autoestinguente, antiurto, anti-UV.
Silver aluminum LED street light with solar panel and lens in anti-UV, self-extinguishing, shockproof material.

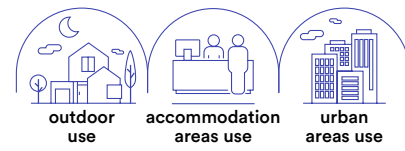

technical information **INVICTUS**



- Materiale**
alluminio

- Materiale pannello solare**
celle in silicio monocristallino

- Colore**
silver

- Temperatura colore**
4000K

- Material**
aluminum

- Solar panel material**
monocrystalline silicon

- Colour**
silver

- Colour temperature**
4000K



LED-INVICTUS-SOLAR 8031414879090	colour temp.	colour
lumen	2400 lm	

watt	15W
beam angle	90° x 120°
pf	0.90

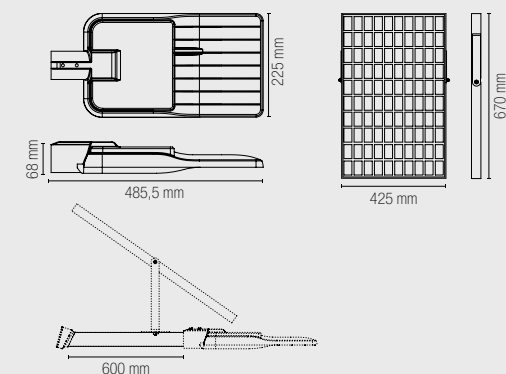

imbocco palo 60mm
60mm pole entry

**Accessori inclusi /
Included accessories**

Radiocomando /
Remote control



Impostazione timer /
Timer setting



Regolazione intensità di luce (dimmer) /
Light intensity (dimmer)



Pannello solare /
Solar panel



Lithium 3.2V 36000 mAh
Batteria ricaricabile
non sostituibile /
Rechargeable battery
non replaceable



**Fotometria del prodotto /
Photometric curve**

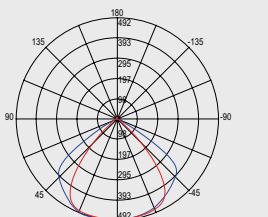

LED-INVICTUS-SOLAR

IPERION

Faro stradale LED in alluminio silver con pannello solare.
Silver aluminum LED street light with solar panel.



Materiale
alluminio

Materiale pannello solare

celle in silicio monocristallino

Colore
silver

Temperatura colore
4000K

Material
aluminum

Solar panel material

monocrystalline silicon

Colour
silver

Colour temperature
4000K



	colour temp.
LED-IPERION-50-SOLAR 8031414879069	9000 lm
LED-IPERION-75-SOLAR 8031414879076	13500 lm

	colour
	6800 lm

watt	50W
beam angle	156° x 71°

Lenti in materiale autoestinguente, antiurto, anti-UV / Lens in anti-UV, self-extinguishing, shockproof material

Sensore microwave
max altezza 6m
raggio 7m /
Microwave sensor
max height 6m
radius 7m

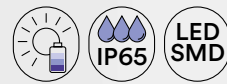

Fotometria del prodotto / Photometric curve

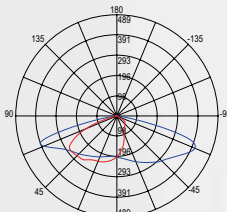

LED-IPERION-50-SOLAR

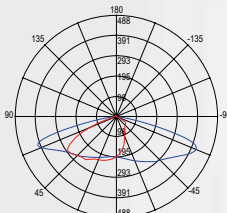

LED-IPERION-75-SOLAR

Accessori inclusi / Included accessories

Palo 60 cm / Pole 60 cm

Pannello solare / Solar panel

50W - lithium 12,8V 54000 mAh
75W - lithium 25,6V 36000 mAh

Batteria ricaricabile non sostituibile / Rechargeable battery non replaceable

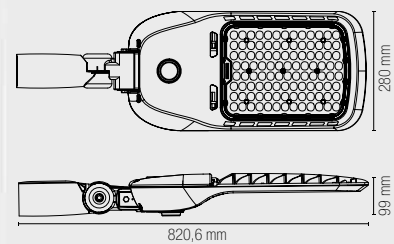

imbocco palo 60 mm / 60 mm pole entry

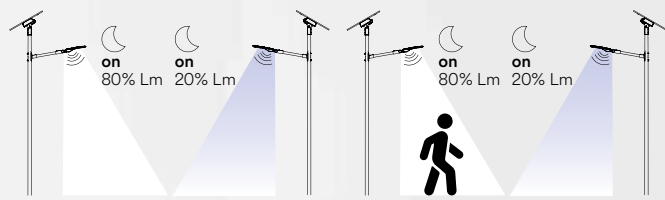

Sensore crepuscolare
ON 80% luce
Dopo 20 secondi 20% luce /
Crepuscular sensor
ON 80% light
After 20 seconds 20% light

Sensore di movimento
ON 80% luce
Dopo 20 secondi 20% luce /
Motion sensor
ON 80% light
After 20 seconds 20% light

FEBO

Faro stradale LED in alluminio con pannello solare.
Aluminum LED street light with solar panel.

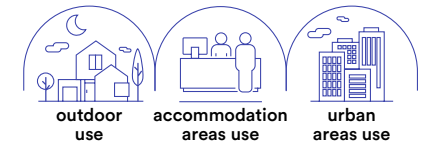

Materiale
alluminio

Materiale pannello solare

celle in silicio monocristallino

Colore
silver

Temperatura colore
4000K

Material
aluminum

Solar panel material

monocrystalline silicon

Colour
silver

Colour temperature
4000K



	colour temp.	colour
LED-FEBO-SOLAR 8031414879052	6800 lm	

watt	40W
beam angle	140° x 85°

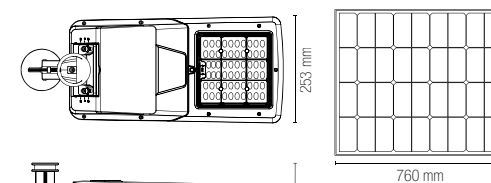

imbocco palo 60 mm / 60 mm pole entry

Lenti in materiale autoestinguente, antiurto, anti-UV / Lens in anti-UV, self-extinguishing, shockproof material



Fotometria del prodotto / Photometric curve

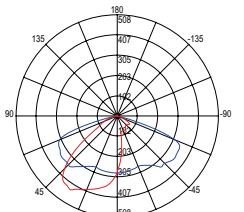

LED-FEBO-SOLAR

Accessori inclusi / Included accessories

Pannello solare / Solar panel

Lithium 12,8V 30AH

Batteria ricaricabile non sostituibile / Rechargeable battery non replaceable

Impostazioni di fabbrica / Default Settings

flux	T1	T2	T3	T4	hours	flux
100%	on <20lux	on	off +12h		T1 <20lux ÷ +2h	100%
60%					T2 T1 ÷ +2h	60%
50%					T3 T2 ÷ +7h	10%
10%					T4 T3 ÷ +2h	50%
					+12h off	

STREETWAY

Faro stradale LED integrato struttura in alluminio pressofuso e diffusore con lenti in materiale autoestinguente, antiurto, anti-UV.

Built-in LED street light die-cast aluminum body and lens in anti-UV, self-extinguishing shockproof material.



technical information **STREETWAY**



- Materiale**
alluminio
- Colore**
silver
- Temperatura colore**
4000K
- Driver**
incluso
- Durata e on/off**
50.000 h
>25.000 on/off
- Material**
aluminum
- Colour**
silver
- Colour temperature**
4000K
- Driver**
included
- Life time and on/off**
50.000 h
>25.000 on/off



	colour temp.	colour
LED-STREETWAY-50 8031414876334	7800 lm	
lumen		
watt	50W	
beam angle	80° x 140°	
pf	0.90	

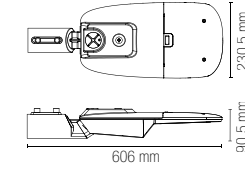

	colour temp.	colour
LED-STREETWAY-100 8031414876341	15500 lm	
lumen		
LED-STREETWAY-100FC 8031414879113	15500 lm	
lumen		
crepuscular sensor	on 6 lux	off 50 lux
watt	100W	
beam angle	80° x 140°	
pf	0.90	

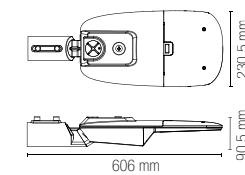

	colour temp.	colour
LED-STREETWAY-150 8031414876358	22000 lm	
lumen		
watt	150W	
beam angle	80° x 140°	
pf	0.90	

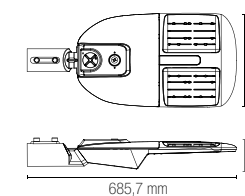

	colour temp.	colour
LED-STREETWAY-200 8031414879106	29900 lm	
lumen		
watt	200W	
beam angle	80° x 140°	
pf	0.90	

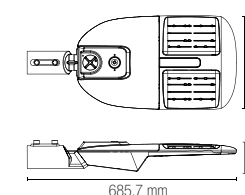

Fotometria del prodotto / Photometric curve

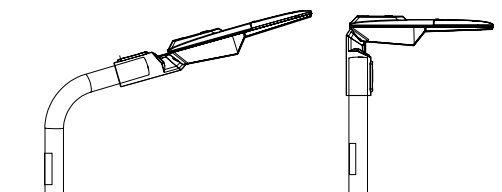
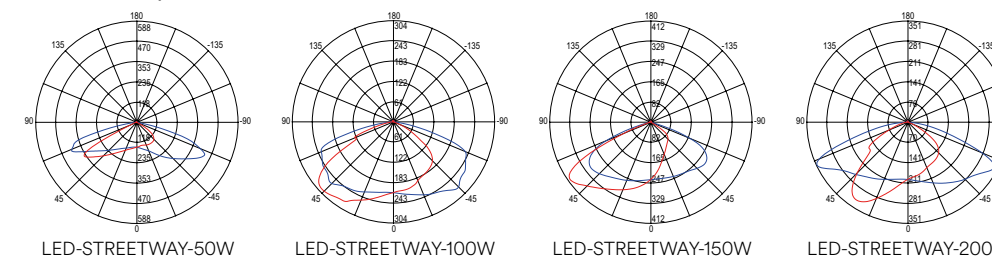

Doppio sistema di montaggio. Per palo Ø 60 mm / Double mounting system. Fit for Ø 60 mm pole

HIGHWAY

Faro stradale LED integrato struttura in alluminio pressofuso e diffusore con lenti in materiale autoestinguente, antiurto, anti-UV.

Built-in LED street light die-cast aluminum body and lens in anti-UV, self-extinguishing shockproof material.



technical information **HIGHWAY**



- Materiale**
alluminio
- Colore**
antracite
- Temperatura colore**
4000K
- Driver**
incluso
- Durata e on/off**
30.000 h
>15.000 on/off
- Material**
aluminum
- Colour**
anthracite
- Colour temperature**
4000K
- Driver**
included
- Life time and on/off**
30.000 h
>15.000 on/off



LED-HIGHWAY-50
8031414877034

lumen	7500 lm
watt	50W
beam angle	135° x 80°
pf	0.90

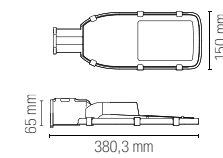

LED-HIGHWAY-100
8031414877041

lumen	14000 lm
watt	100W
beam angle	135° x 80°
pf	0.90

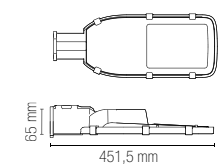

LED-HIGHWAY-150
8031414877058

lumen	20000 lm
watt	150W
beam angle	135° x 80°
pf	0.90

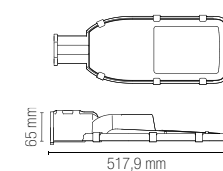

LED-HIGHWAY-ADAT
8031414877904

Adattatore 90° armature stradali highway imbocco palo 60 mm / 90° adapter 60 mm pole entry for street light

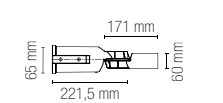

Fotometria del prodotto / Photometric curve

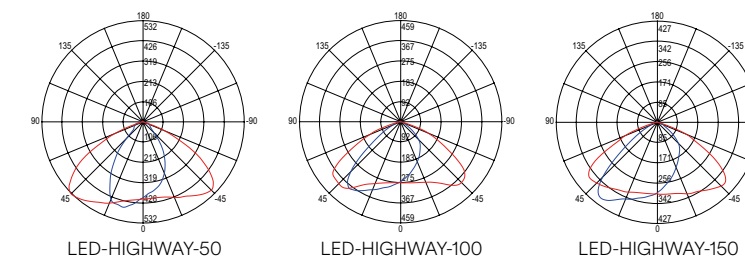

POLIS

Faro stradale LED con fissaggio su palo verticale orizzontale più versione a sospensione, in alluminio pressofuso con diffusore in vetro temperato.

Built-in LED street light die-cast aluminum body with tempered glass diffuser structure with mount bracket on vertical or horizontal pole and version with suspension mount bracket.

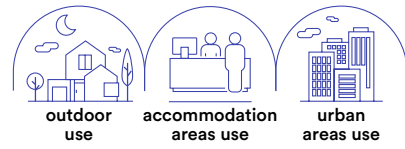

technical information **POLIS**



Materiale
alluminio pressofuso

Colore
silver

Temperatura colore
4000K

Driver
incluso

Durata e on/off
50.000 h
>25.000 on/off

Material
die-cast aluminum

Colour
silver

Colour temperature
4000K

Driver
included

Life time and on/off
50.000 h
>25.000 on/off

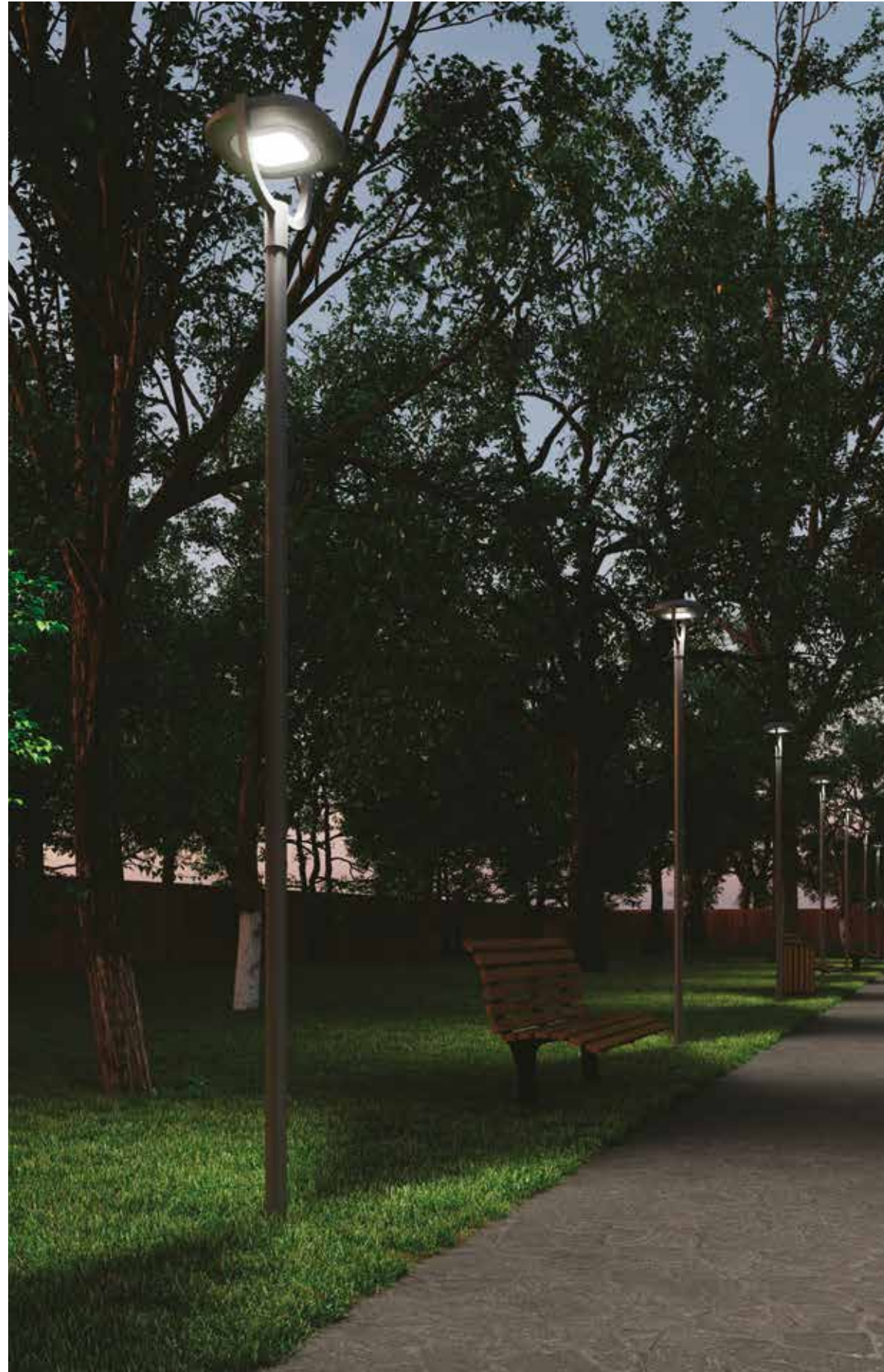

LED-POLIS-50
8031414879465
lumen

colour temp.	colour
7000 lm	

watt	50W
beam angle	155° x 75°
pf	0.90

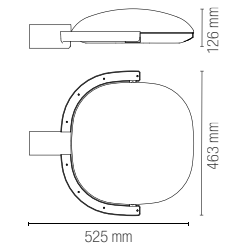

imbocco palo 60mm
60mm pole entry

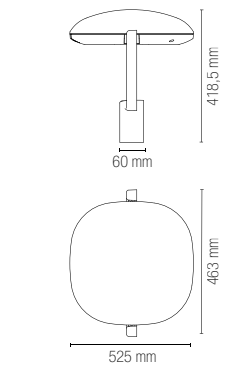

LED-POLIS-S50
8031414879472
lumen

colour temp.	colour
7000 lm	

watt	50W
beam angle	155° x 75°
pf	0.90

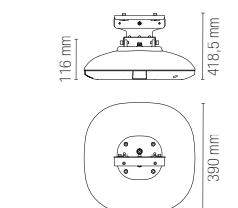

Fotometria del prodotto / Photometric curve

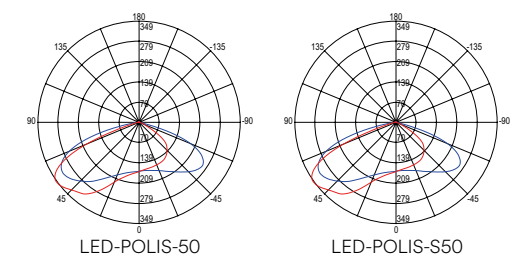

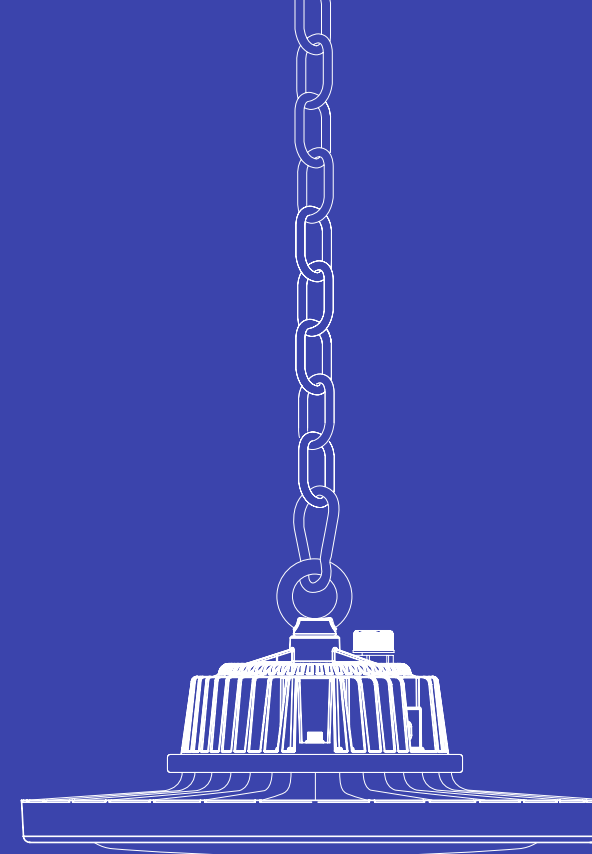

HIGH BAY &

TRI-PROOF

STARGATE XP

Lampada LED high bay in alluminio nero.
Black aluminium high bay LED lamp.

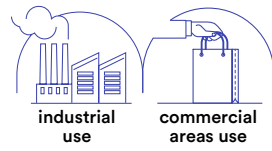

- Materiale**
alluminio
- Colore**
nero
- Temperatura colore**
4000K
- Driver**
incluso
- Durata e on/off**
50.000 h
>25.000 on/off
- Material**
aluminum
- Colour**
black
- Colour temperature**
4000K
- Driver**
included
- Life time and on/off**
50.000 h
>25.000 on/off



	colour temp.		colour temp.		colour temp.
LED-STARGATE-100XP 8031414877799	14800 lm	LED-STARGATE-150XP 8031414877805	22200 lm	LED-STARGATE-200XP 8031414877812	29500 lm
lumen		lumen		lumen	
watt	100W	watt	150W	watt	200W
beam angle	110°	beam angle	110°	beam angle	110°
pf	0.90	pf	0.90	pf	0.90

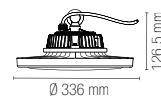
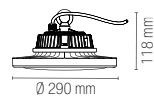

Fotometria del prodotto / Photometric curve

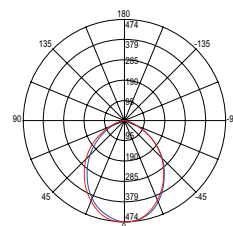

LED-STARGATE-100XP

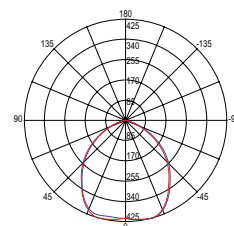

LED-STARGATE-150XP

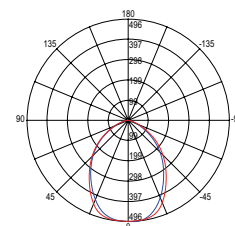

LED-STARGATE-200XP

ATLANTIC

Plafoniera stagna per tubi a LED bilampada in PC+PC.
Waterproof lamp for double LED tube in PC+PC.

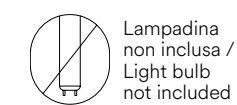
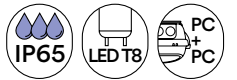
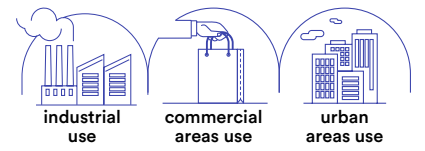

LED-ATLANTIC-ST-60 8031440355315	LED-ATLANTIC-ST-120 8031440355322	LED-ATLANTIC-ST-150 8031440355292
2 x T8 230V	2 x T8 230V	2 x T8 230V

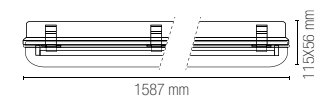
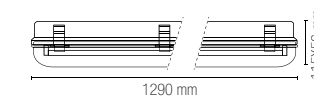
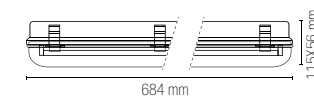

HIGH BAY & TRI-PROOF
In.tec light



LED-SENSOR-HB-DIM
 8031414879748
 120-277V
 Load capacity
 120VAC: 4A
 277VAC: 3A



1 / function

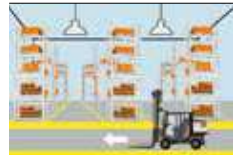

In un ambiente sufficientemente luminoso la lampada non si accende anche se viene rilevato movimento.

With sufficient ambient light, the light will not be switched on even if with motion signal.



In un ambiente poco luminoso il sensore accende la lampada non appena viene rilevato un movimento.

With insufficient ambient light, the sensor switches on the light when motion is detected.

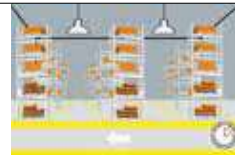

Trascorso il tempo di attesa, il sensore spegne la lampada quando non viene rilevato movimento.

After elapse of hold time, the sensor switches off the light when no motion is detected.

2 / function



Se non viene rilevato movimento la lampada rimane ad un basso livello di luminosità.

If there is motion detected, the light will be remained at a low light level all the time.



Quando viene rilevato movimento, il sensore porta la lampada al 100% di luminosità.

When motion is detected, the sensor will switch on the light to 100% brightness.



Trascorso il tempo di attesa, il sensore attenua la luce all'attuale livello di luminosità se non è rilevato movimento.

After elapse of hold time, the sensor dims the light at present low light level if no motion is detected.

3 / function

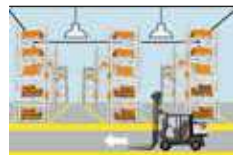

In un ambiente sufficientemente luminoso la lampada non si accende anche se viene rilevato movimento.

With sufficient ambient light, the light will not be switched on even if with motion signal.



In un ambiente poco luminoso il sensore accende la lampada non appena viene rilevato un movimento.

With insufficient ambient light, the sensor switches on the light when motion is detected.



Trascorso il tempo di attesa, il sensore attenua la luce all'attuale livello di luminosità se non è rilevato movimento.

After elapse of hold time, the sensor dims the light at present low light level if no motion is detected.



Trascorso il tempo di standby il sensore spegne la lampada se non è rilevato movimento.

After elapse of standby period, the sensor switches off the light if no motion is detected.



LED-SENSOR-HB
 8031414879731
 Load capacity
 400W
 220V - 240V

Accessori inclusi /
 Included accessories



1 / function

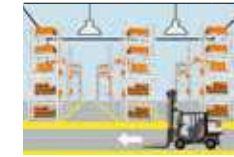

In un ambiente sufficientemente luminoso la lampada non si accende anche se viene rilevato movimento.

With sufficient ambient light, the light will not be switched on even if with motion signal.



In un ambiente poco luminoso il sensore accende la lampada non appena viene rilevato un movimento.

With insufficient ambient light, the sensor switches on the light when motion is detected.

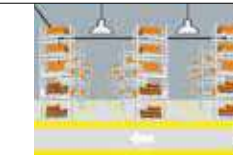

Trascorso il tempo di attesa, il sensore spegne la lampada quando non viene rilevato movimento.

After elapse of hold time, the sensor switches off the light when no motion is detected.



LED-SENSOR-TP
 8031414879724
 Load capacity
 no limitation
 220V - 240V



1 / function

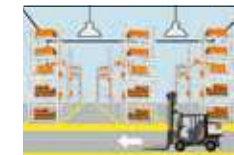

In un ambiente sufficientemente luminoso la lampada non si accende anche se viene rilevato movimento.

With sufficient ambient light, the light will not be switched on even if with motion signal.

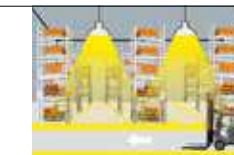

In un ambiente poco luminoso il sensore accende la lampada non appena viene rilevato un movimento.

With insufficient ambient light, the sensor switches on the light when motion is detected.

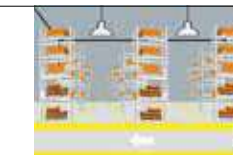

Trascorso il tempo di attesa, il sensore spegne la lampada quando non viene rilevato movimento.

After elapse of hold time, the sensor switches off the light when no motion is detected.



LED-SENSOR-REMOTE
 8031414879717
 Radiocomando per sensori industriali. Industrial sensor remote control.

NAUTILUS

Plafoniere stagno in policarbonato.
Waterproof ceiling lamps in polycarbonate.

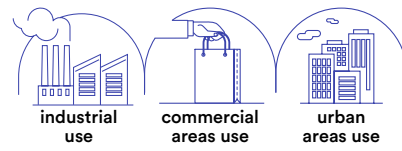

technical information NAUTILUS



- Materiale**
policarbonato
- Colore**
silver
- Temperatura colore**
4000K
- Driver**
integrato
- Durata e on/off**
50.000 h
>25.000 on/off
- Material**
policarbonate
- Colour**
silver
- Colour temperature**
4000K
- Driver**
built-in
- Life time and on/off**
50.000 h
>25.000 on/off

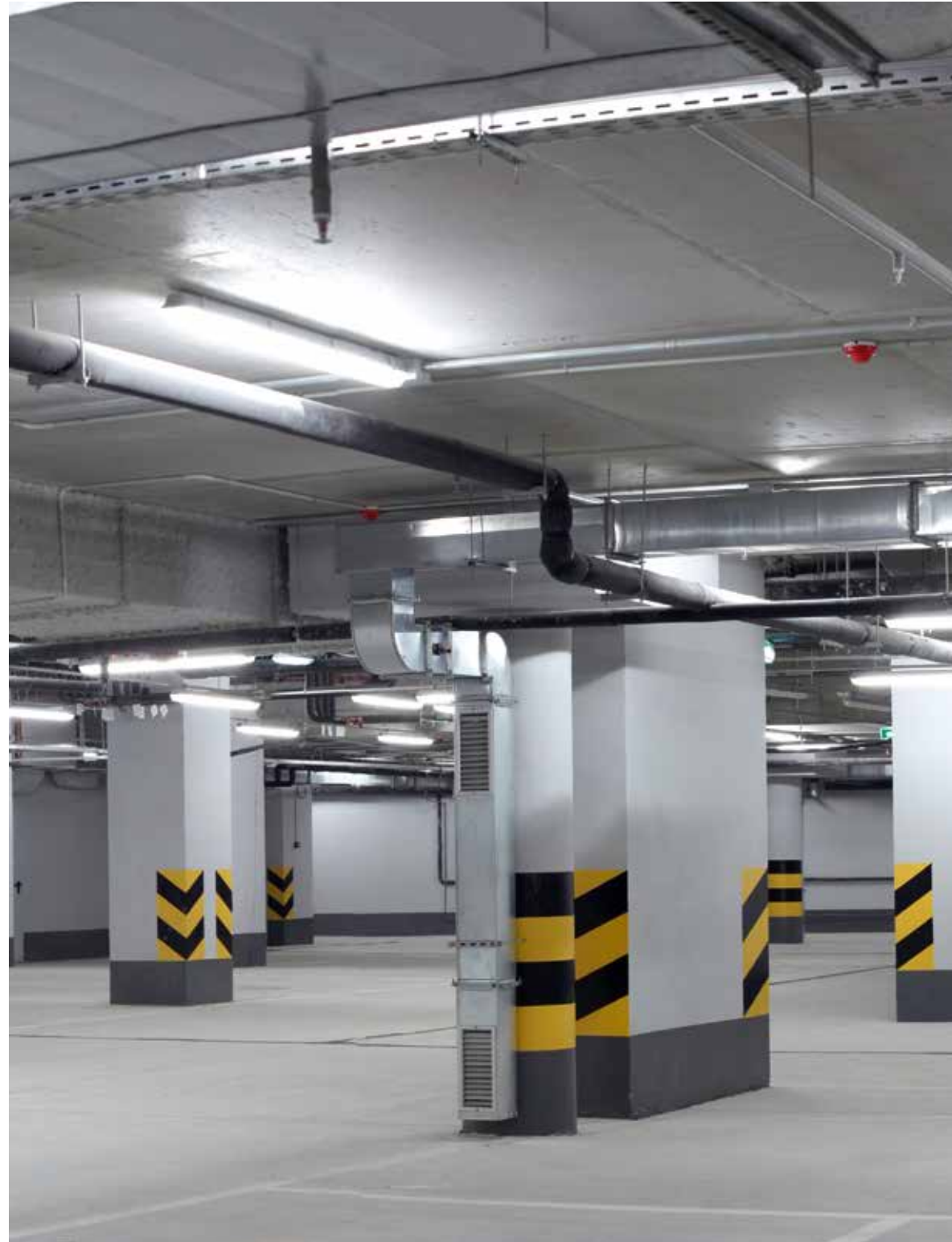

Fotometria del prodotto
Photometric curve

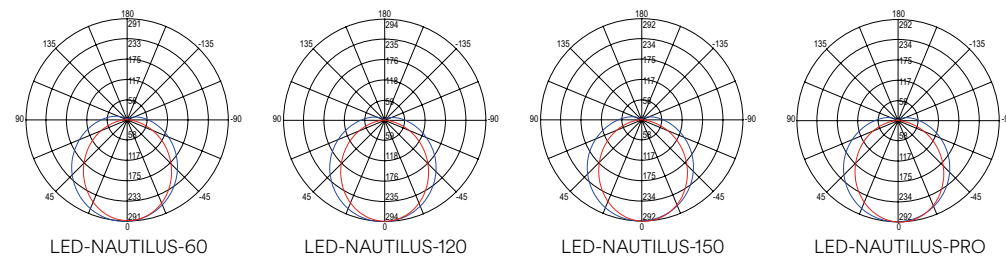

LED-NAUTILUS-60
8031414876501
lumen

colour temp.	colour
2900 lm	

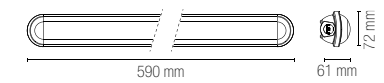

watt	21W
beam angle	120°
pf	-



LED-NAUTILUS-120
8031414876518
lumen

colour temp.	colour
5400 lm	

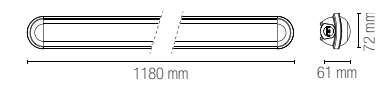

watt	40W
beam angle	120°
pf	0.90



LED-NAUTILUS-150
8031414876525
lumen

colour temp.	colour
7500 lm	

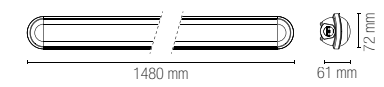

watt	55W
beam angle	120°
pf	0.90



LED-NAUTILUS-PRO
8031414876532
lumen

colour temp.	colour
10600 lm	

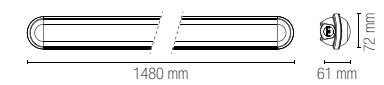

watt	80W
beam angle	120°
pf	0.90



NAUTILUS-SENS
8031414878758

In un ambiente sufficientemente luminoso la lampada non si accende anche se viene rilevato movimento.

With sufficient ambient light, the light will not be switched on even if with motion signal.

In un ambiente poco luminoso il sensore accende la lampada non appena viene rilevato un movimento.

With insufficient ambient light, the sensor switches on the light when motion is detected.

Trascorso il tempo di attesa, il sensore spegne la lampada quando non viene rilevato movimento.

After elapse of hold time, the sensor switches off the light when no motion is detected.

ARTIC

Plafoniera stagna LED integrato in policarbonato.
Built-in LED TRI PROOF ceiling lamps in PC.

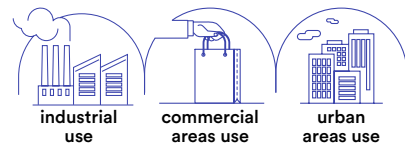

- Materiale**
policarbonato
- Colore**
bianco
- Temperatura colore**
4000K
- Driver**
integrato
- Durata e on/off**
50.000 h
>25.000 on/off
- Material**
polycarbonate
- Colour**
white
- Colour temperature**
4000K
- Driver**
built-in
- Life time and on/off**
50.000 h
>25.000 on/off



	colour temp.	watt	pf	colour
LED-ARTIC-30 8031414882625 lumen	4000K	9W	-	white
LED-ARTIC-60 8031414882632 lumen	4000K	15W	-	white
LED-ARTIC-120 8031414882601 lumen	4000K	30W	0.90	white
LED-ARTIC-150 8031414882618 lumen	4000K	45W	0.90	white

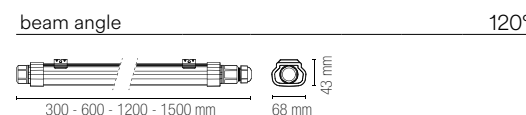

Fotometria del prodotto / Photometric curve

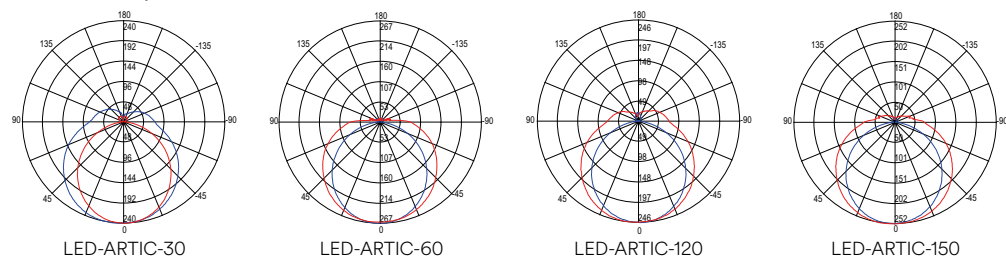

OCEAN

Plafoniera stagna LED integrato in policarbonato.
Built-in LED TRI PROOF ceiling lamps in PC.

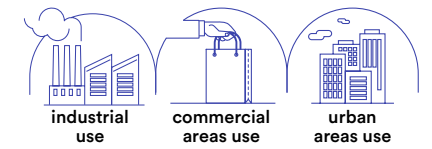

- Materiale**
policarbonato
- Colore**
bianco
- Temperatura colore**
4000K
- Driver**
integrato
- Durata e on/off**
30.000 h
>15.000 on/off
- Material**
polycarbonate
- Colour**
white
- Colour temperature**
4000K
- Driver**
built-in
- Life time and on/off**
30.000 h
>15.000 on/off



	colour temp.	colour
LED-OCEAN-SENS 8031414868858 lumen	4000K	white
watt	36W	
beam angle	120°	
pf	0.90	

Accessori inclusi / Included accessories

crepuscular sensor	motion sensor
<p>Sensore microonde di movimento / Microwave motion sensor</p>	

HIGH BAY & TRI-PROOF In.tec light

CONCORDE

Plafoniera stagna in policarbonato LED integrato.
PC LED TRI PROOF light.

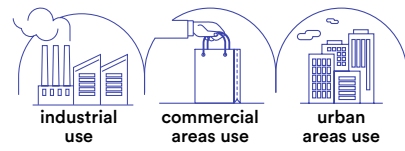

- Materiale**
policarbonato
- Colore**
bianco
- Temperatura colore**
4000K
- Driver**
integrato
- Durata e on/off**
50.000 h
>25.000 on/off
- Material**
polycarbonate
- Colour**
white
- Colour temperature**
4000K
- Driver**
built-in
- Life time and on/off**
50.000 h
>25.000 on/off



	colour temp.	watt	pf	colour
LED-CONCORDE-70 8031414868346 lumen	●	3900 lm	30W 0.90	●
LED-CONCORDE-130 8031414066766 lumen	●	7800 lm	60W 0.90	●
LED-CONCORDE-160 8031414868353 lumen	●	9700 lm	75W 0.90	●
beam angle	120°			

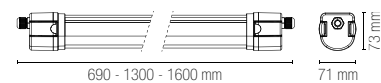

Fotometria del prodotto / Photometric curve

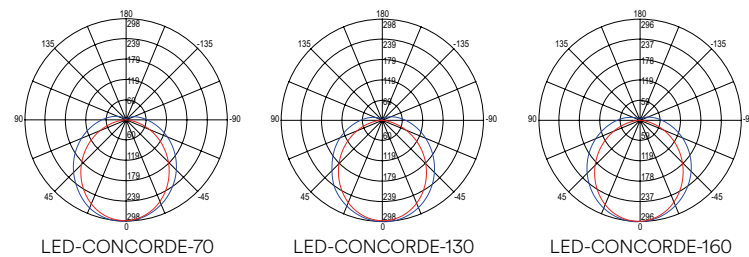

SUPERIA

Lampada LED high bay in alluminio silver.
Aluminium linear high bay LED lamp silver finish.

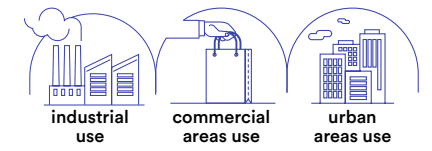

- Materiale**
alluminio
- Colore**
silver
- Temperatura colore**
4000K
- Driver**
incluso
- Durata e on/off**
50.000 h
>25.000 on/off
- Material**
aluminium
- Colour**
silver
- Colour temperature**
4000K
- Driver**
included
- Life time and on/off**
50.000 h
>25.000 on/off



	colour temp.	watt	pf	colour
LED-SUPERIA-100 8031414868315 lumen	●	15000 lm	100W 0.90	●
LED-SUPERIA-150 8031414868865 lumen	●	22500 lm	150W 0.90	●
LED-SUPERIA-200 8031414868322 lumen	●	30000 lm	200W 0.90	●
beam angle	120°			

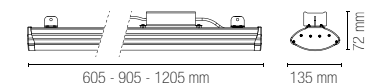

Fotometria del prodotto / Photometric curve

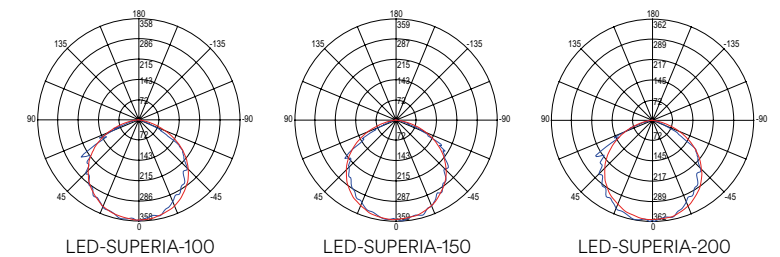

Accessori inclusi / Included accessories

Cavo 1m /
1m cable
Kit sospensione /
Suspension kit



Accessori non inclusi / Not included accessories

LED-SUPERIA-PL
8031414870899
Kit 2 pz orientabile 60°± /
Kit 2 pcs adjustable 60°±



LED-SUPERIA-SOSP
8031414871803
Kit fissaggio a sospensione
2 cavi 5m /
Suspension mounting kit
2 cables 5m



I-DRIVER-SUPERIA-HELP
8031414868339



emergency light IP20 - 3 h - 20W

HIGH BAY & TRI-PROOF
In.tec light



EASY DOMOTIC

24V

EASY DOMOTICA 24V

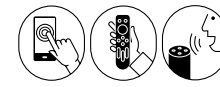

Con questo segmento tecnico intendiamo soddisfare al meglio la crescente esigenza di migliorare la qualità di vita domestica, e lavorativa attraverso l'utilizzo di dispositivi di illuminazione sempre più interconnessi fra loro tramite collegamenti sempre più semplificati dalle tecnologie wireless.

I dispositivi di illuminazione diventano uno strumento estremamente personalizzato e modulabile che si fondono, anche in diversi momenti della giornata, con le evolute esigenze di illuminazione non più fine a se stessa ma adattata ai diversi umori sia di una utenza professionale che di una utenza domestica o ludica. Questa sezione raggruppa diverse tipologie di prodotti 24V (ad esempio indoor e outdoor) che, grazie all'utilizzo di accessori easy connector, possono essere connessi tra di loro per il controllo simultaneo. Il controllo dei dispositivi diventa easy: la connessione ad alimentatori a tensione costante in parallelo è compatibile con centraline di controllo in Radio Frequenza 2.4G, Infrarossi, Wifi o Bluetooth e le centraline, a loro volta, prevedono interfacce wifi, bluetooth oppure possono essere controllate tramite wall pad o radiocomandi.

With this technical segment, we intend meet in the best way the growing need to improve the quality of home and working life through the use of lighting devices that are increasingly interconnected with each other through connections that are increasingly simplified by wireless technologies.

The lighting devices become an extremely personalized and modular tool that merge, even at different times of the day, with the evolved lighting needs no longer as light source itself but light adapted to the different moods of both professional users, domestic users, playful users. This section groups 24V products (for example indoor or outdoor) that, thanks to easy connector accessories, can be connected each other for simultaneous control. Devices control becomes easy: constant voltage power supply in parallel connection system are compatible with 2.4G Radio Frequency, Infrared, Wifi or Bluetooth control units and the control units can be controlled by wifi, bluetooth devices or via a wall pad or remote control.

	<p>CAVO-4CH-CONN-MF 8031414878772</p> <p>100 cm Cavo di connessione connettore M+F</p> <p>100 cm Connection cable M+F connector</p> <p>IP67</p>	
	<p>CAVO-4CH-CONN-T 8031414878789</p> <p>40+20 cm Cavo di connessione a T connettore M+F+F</p> <p>40+20 cm T connection cable M+F+F connector</p> <p>IP67</p>	
	<p>CAVO-4CH-CONN-M 8031414878796</p> <p>50 cm Cavo di connessione connettore M+cavi sciolti</p> <p>50 cm Connection cable M+cables</p> <p>IP67</p>	

XANTO-RF

Incasso in alluminio pressofuso antiriflesso con cavo easy connection integrato.
Diecast aluminum anti-glare down-light with built-in easy domotic cable.

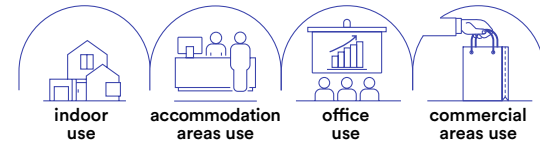

Materiale
alluminio pressofuso

Colore
bianco

Temperatura colore
RGB + 4000K



Driver

DC 24V non incluso
Tensione costante
connessione
in parallelo

Durata e on/off

25.000h
>15.000 on/off

Material

die cast aluminum

Colour

white

Colour temperature
RGB + 4000K



Driver

DC 24V not included
Costant voltage
parallel connecting
system

Life time and on/off

25.000 h
>15.000 on/off

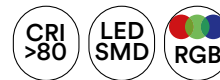

Driver p. 837-846
Controller p. 848-851



INC-XANTO-R120-24V
8031414877942
lumen

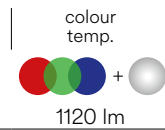

1120 lm

watt 12W
beam angle 120°
pf -

Ø 110 mm

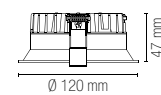

INC-XANTO-R220-24V
8031414878697
lumen

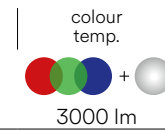

3000 lm

watt 30W
beam angle 120°
pf 0.90

Ø 200 mm

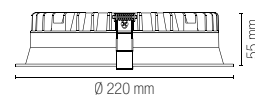

Fotometria del prodotto /
Photometric curve

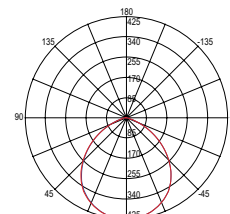

INC-XANTO-R120-24V

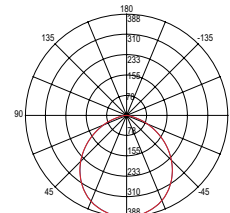

INC-XANTO-R220-24V

PANEL

Pannello LED con struttura in alluminio diffusore in acrilico con cavo easy connection integrato.
LED panel with aluminum structure and acrylic diffuser with built-in easy domotic cable.

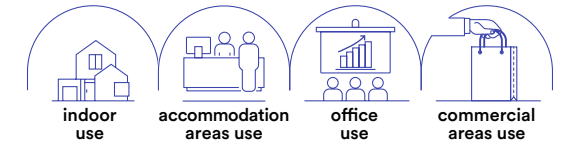

Materiale
alluminio
diffusore in acrilico

Colore
bianco

Temperatura colore
RGB + 4000K



Driver

DC24V
tensione costante
non incluso

Durata e on/off

20.000h
>10.000 on/off

Material

aluminum
acrylic diffuser

Colour

white

Colour temperature
RGB + 4000K



Driver

DC24V
costant voltage
not included

Life time and on/off

20.000h
>10.000 on/off

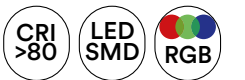

Driver p. 837-846
Controller p. 848-851



LED-PANEL-60X60-24V
8031414875313
lumen

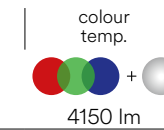

4150 lm

watt 30W
beam angle 120°
pf 0.90

590 x 590 mm

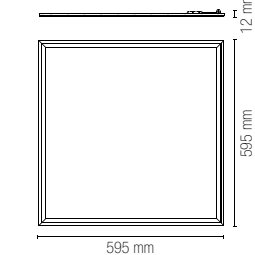

Fotometria del prodotto /
Photometric curve

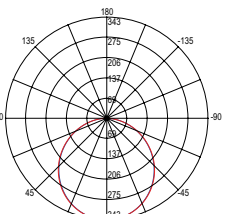

LED-PANEL-60x60-24V

STRIP

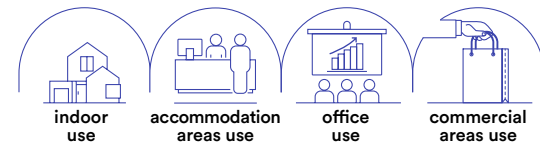

Rotolo 5 metri strip led.
Roll 5 meters strip-led.



CE
Driver p. 837-846
Controller p. 848-851

Materiale
kapton
senza silicone

Temperatura colore
RGB + 4000K

Driver
DC24V
tensione costante
non incluso

Durata e on/off
50.000h
>25.000 on/off

Material
kapton
without silicone

Colour temperature
RGB + 4000K

Driver
DC24V
constant voltage
not included

Life time and on/off
50.000h
>25.000 on/off

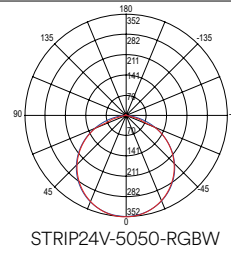

STRIP24V-5050-RGBW

5 m

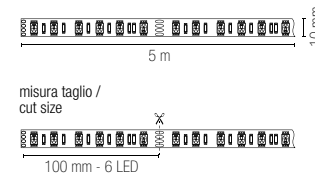

STRIP24V-5050-RGBW
8031414871384
lumen

colour temp.
 5400 lm/m

light source SMD 5050
watt/m 19,2W
led/m 60

Rotolo 5 metri strip led.
Roll 5 meters strip-led.



CE
Driver p. 837-846
Controller p. 848-851

Materiale
kapton con
rivestimento
in silicone

Temperatura colore
RGB + 4000K

Driver
DC24V
tensione costante
non incluso

Durata e on/off
50.000h
>25.000 on/off

Material
kapton
with silicone
cover

Colour temperature
RGB + 4000K

Driver
DC24V
constant voltage
not included

Life time and on/off
50.000h
>25.000 on/off

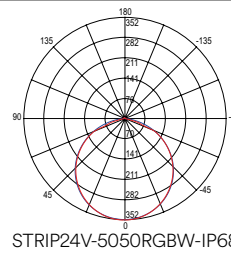

STRIP24V-5050RGBW-IP68

5 m

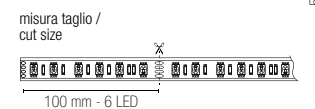

STRIP24V-5050RGBW-IP68
8031414871407
lumen

colour temp.
 5400 lm/m

light source SMD 5050
watt/m 19,2W
led/m 60

TARGET



**Faro proiettore in alluminio con picchetto
incluso, cavo easy connection integrato.**
Aluminum flood light with spike included,
built-in easy domotic cable.

Materiale
alluminio

Colore
nero

Temperatura colore
RGB + 4000K



Driver
DC24V

tensione costante
non incluso

Durata e on/off
30.000h
>15.000 on/off

Material
aluminum

Colour
black

Colour temperature
RGB + 4000K



Driver
DC24V

constant voltage
not included

Life time and on/off
30.000h
>15.000 on/off

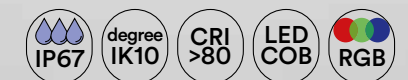

Driver p. 837-846
Controller p. 848-851



LED-TARGET-8-24V
8031414878604
lumen

colour temp.
 190 lm

watt 8W
beam angle 30°

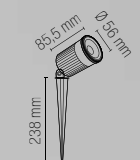

LED-TARGET-30-24V
8031414878550
lumen

colour temp.
 468 lm

watt 30W
beam angle 30°

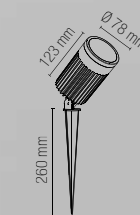

Fotometria del prodotto /
Photometric curve

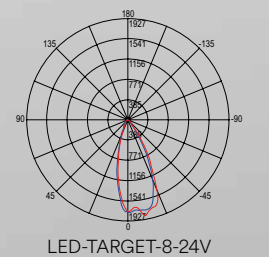

LED-TARGET-8-24V

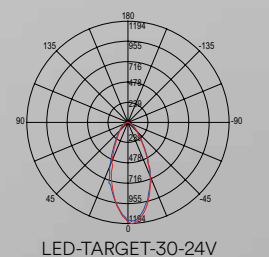

LED-TARGET-30-24V

SPRINT

Segnapassi incasso a pavimento o parete con cavo easy connection integrato.

Inground and wall recessed light with built-in easy domotic cable.



Materiale
alluminio

Colore
acciaio



Temperatura colore
RGB + 4000K



Driver

DC 24V
tensione costante
non incluso

Durata e on/off
25.000h
>10.000 on/off

Material
aluminum

Colour
stainless steel



Colour temperature
RGB + 4000K



Driver

DC 24V
constant voltage
not included

Life time and on/off
25.000h
>10.000 on/off



Driver p. 837-846
Controller p. 848-851



Fotometria del prodotto /
Photometric curve

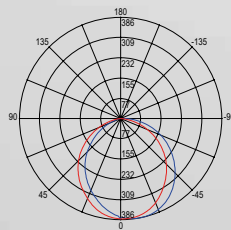

LED-SPRINT-R5-24V

LED-SPRINT-R5-24V
8031414878543
lumen

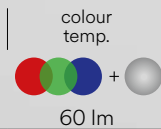

60 lm

**Accessori inclusi /
Included accessories**

x1
Cassetta di
derivazione /
Recessed box

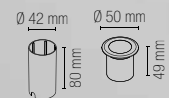

watt 1,5W
beam angle 108°
Ø 42 mm

RUNNER

Segnapassi incasso a pavimento o parete con cavo easy connection integrato.

Inground and wall recessed light with built-in easy domotic cable.



Materiale
alluminio

Colore
nikel spazzolato



Temperatura colore
RGB + 4000K



Driver

DC 24V
tensione costante
non incluso

Durata e on/off
30.000h
>15.000 on/off

Material
aluminum

Colour
brushed nickel



Colour temperature
RGB + 4000K



Driver

DC 24V
constant voltage
not included

Life time and on/off
30.000h
>15.000 on/off



Driver p. 837-846
Controller p. 848-851



Fotometria del prodotto /
Photometric curve

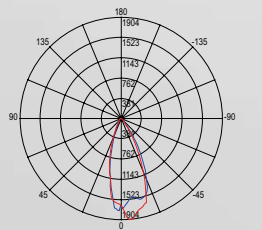

LED-RUNNER-Q8-24V
LED-RUNNER-R8-24V

LED-RUNNER-Q8-24V
8031414878536
lumen

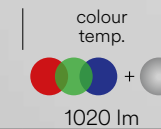

1020 lm

**Accessori inclusi /
Included accessories**

x1
Cassetta di
derivazione /
Recessed box

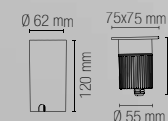

watt 10W
beam angle 30°
Ø 63 mm



LED-RUNNER-R8-24V
8031414878567
lumen

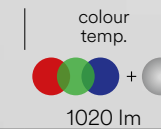

1020 lm

watt 10W
beam angle 30°
Ø 63 mm



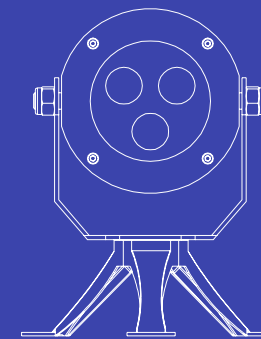

LUCI DECORATIVE TECNICHE DMX

DMX TECHNICAL DECORATION LIGHTING



technical information **RAYS**



Proiettore LED RGB FULL COLOR in alluminio.
LED RGB FULL COLOR lamp in aluminium.



Materiale
alluminio

Temperatura colore
RGB full color



Driver
incluso

Durata e on/off
50.000h
>25.000 on/off

Material
aluminum

Colour temperature
RGB full color



Driver
included

Life time and on/off
50.000h
>25.000 on/off

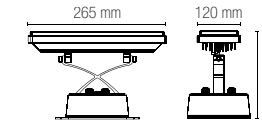

LED-RAYS-30P
8031440358071
lumen

watt 30 × 1W
beam angle 45°

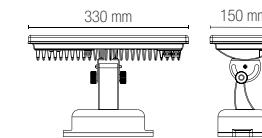
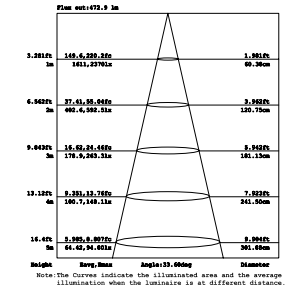
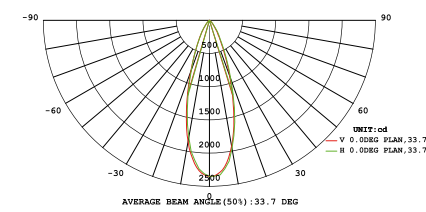
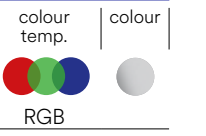

LED-RAYS-36P
8031440355445
lumen

watt 30 × 1W
beam angle 45°

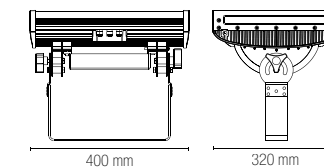
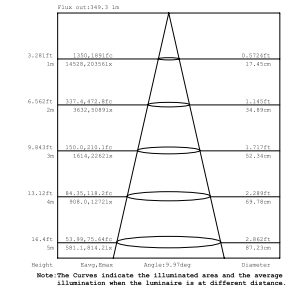
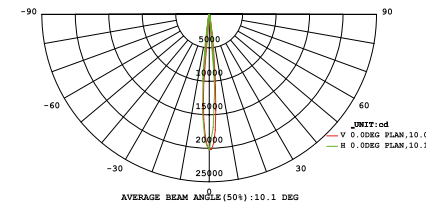
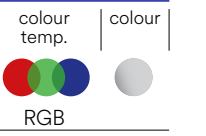

LED-RAYS-72P
8031440358040
lumen

watt 72 × 2W
beam angle 45°

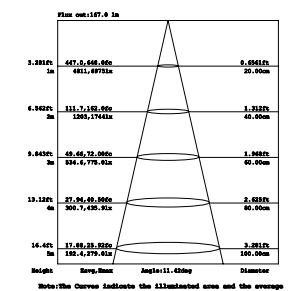
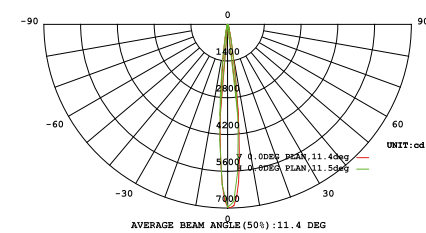

WALLWASHER

Proiettore LED RGB FULL COLOR in alluminio.
LED RGB FULL COLOR lamp in aluminium.

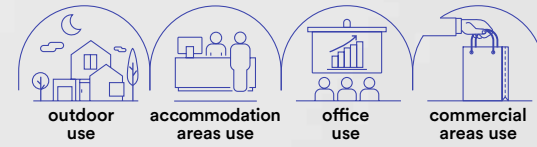

technical information **WALLWASHER**



Materiale
alluminio

Temperatura colore
RGB full color



Driver
integrato

Durata e on/off
50.000h
>25.000 on/off

Material
aluminum

Colour temperature
RGB full color



Driver
built-in

Life time and on/off
50.000h
>25.000 on/off

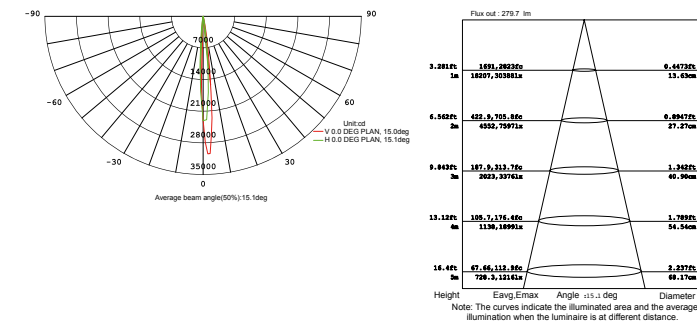

LED-WALLWASHER-18
8031440359559
lumen

colour temp. **RGB** colour

watt **18 x 2W**
beam angle **45°**

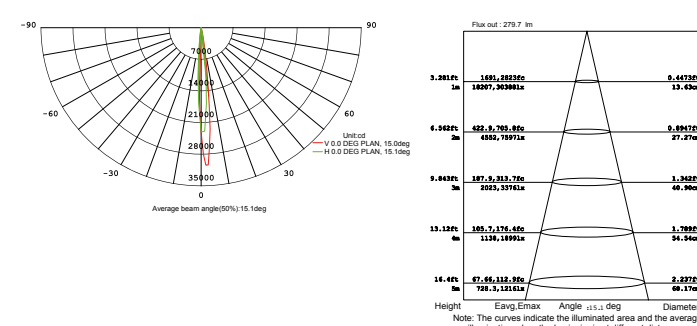
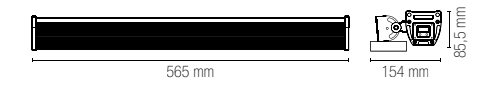

LED-WALLWASHER-36
8031440359528
lumen

colour temp. **RGB** colour

watt **36 x 2W**
beam angle **45°**



LUCI DECORATIVE TECNICHE DMX / DMX TECHNICAL DECORATION LIGHTING

In.tec light

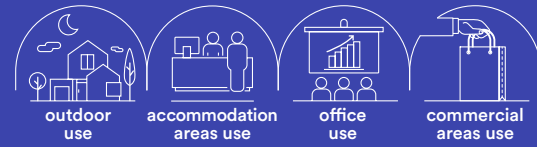

technical information **IRIDE**



**Proiettore LED monocolor
o RGB FULL COLOR in alluminio.**
LED single colour or RGB FULL
COLOR lamp in aluminium.



Materiale
alluminio

Temperatura colore
RGB full color + 6000K



Driver
DC 12/24V
non incluso

Durata e on/off
50.000h
>25.000 on/off

Material
aluminum

Colour temperature
RGB full color + 6000K



Driver
DC 12/24V
not included

Life time and on/off
50.000h
>25.000 on/off



LED-IRIDE-3P
8031440358101
lumen

colour temp. colour
RGB

watt 3 x 1W
driver DC12/24V
beam angle 45°

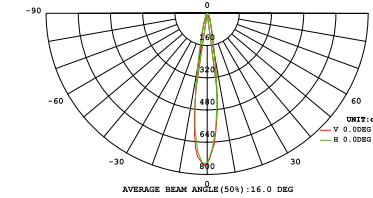
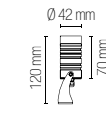

colour temp. colour
240 lm

LED-IRIDE-3P-BCO
8031440359719
lumen

watt 3 x 1W
driver DC12/24V
beam angle 30°

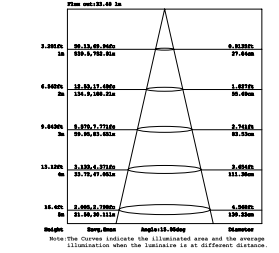

LED-IRIDE-9P
8031440358118
lumen

colour temp. colour
RGB

watt 9 x 1W
driver DC12/24V
beam angle 40°

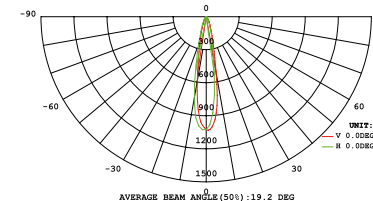
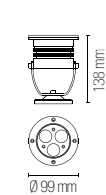

colour temp. colour
720 lm

LED-IRIDE-9P-BCO
8031440359702
lumen

watt 9 x 1W
driver DC12/24V
beam angle 30°

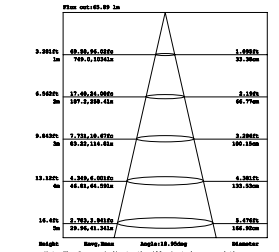

LED-IRIDE-18P
8031440358088
lumen

colour temp. colour
RGB

watt 18 x 1W
driver DC24V
beam angle 40°

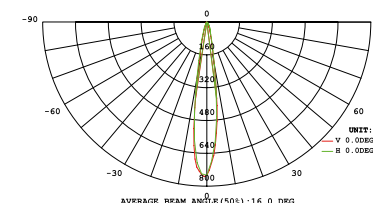
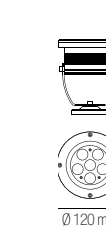

colour temp. colour
1620 lm

LED-IRIDE-18P-BCO
8031440359689
lumen

watt 18 x 1W
driver DC24V
beam angle 30°

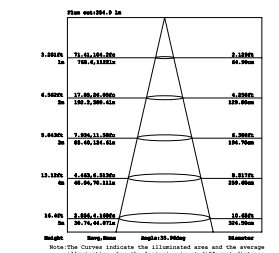



technical information **IRIDE**



Incassi calpestabili LED RGB FULL COLOR
corpo in lega di alluminio, ghiera in acciaio 316.
 Walkable built-in LED RGB FULL COLOR light 316
 stainless steel cover and aluminium alloy housing.



Materiale
 alluminio pressofuso

Temperatura colore
 RGB full color



Driver
 DC 12/24V
 non incluso

Durata e on/off
 50.000h
 >25.000 on/off

Material
 die cast aluminum

Colour temperature
 RGB full color



Driver
 DC 12/24V
 not included

Life time and on/off
 50.000h
 >25.000 on/off



LED-IRIDE-R6
 8031414868971
 lumen

colour temp. colour recessed box



watt 3 x 1W
 driver DC12/24V
 beam angle 15°

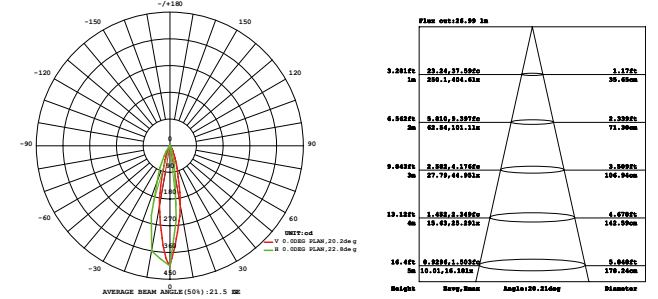
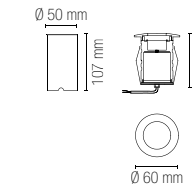
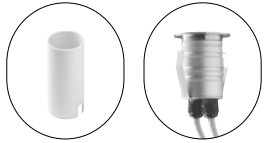

LED-IRIDE-R12
 8031414868988
 lumen

colour temp. colour recessed box



watt 9 x 1W
 driver DC12/24V
 beam angle 15°

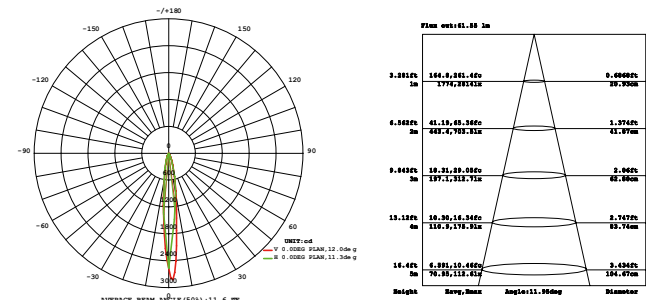
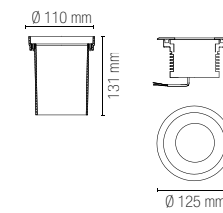
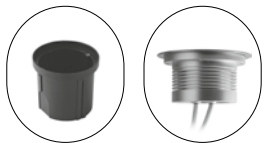

LED-IRIDE-R14
 8031414868995
 lumen

colour temp. colour recessed box



watt 18 x 1W
 driver DC12/24V
 beam angle 15°

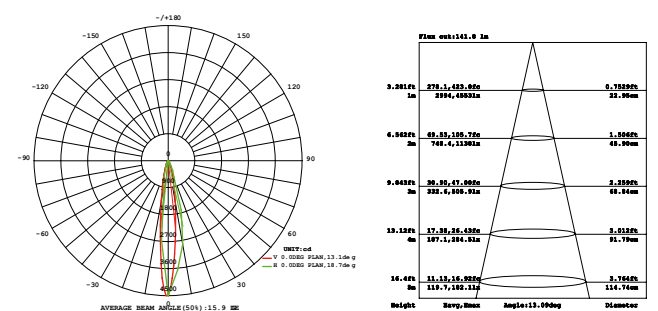
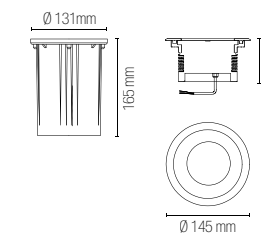
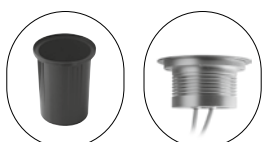

NEPTUNE

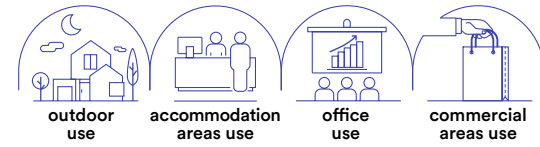

CROWN

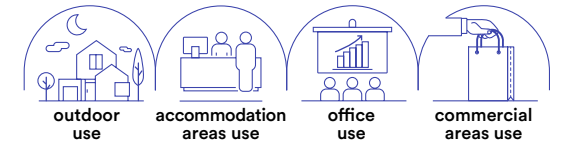

Materiale
acciaio inox 316

Colore
silver
nero



Temperatura colore
RGB full color



Driver
DC24V
non incluso

Durata e on/off
50.000h
>25.000 on/off

Material
316 stainless steel

Colour
black
silver



Colour temperature
RGB full color



Driver
DC24V
not included

Life time and on/off
50.000h
>25.000 on/off

Proiettori per fontane LED RGB FULL COLOR.
LED RGB FULL COLOR fountain flood lamp.



LED-NEPTUNE-3P
8031414869008
lumen

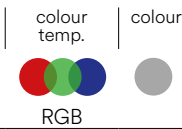

watt $3 \times 3W$
beam angle 25°

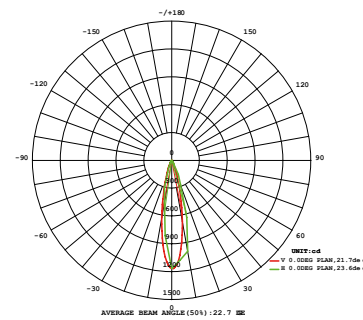
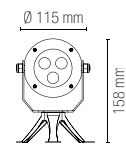

Height	Beam Max	Angle: 25.00deg	Diameter
0.2010m	73.49, 118.20m		1.0270m
0.4020m	147.9, 236.41m		2.0540m
0.6030m	221.85, 354.61m		3.0810m
0.8040m	295.8, 472.81m		4.1080m
1.0050m	369.75, 591.01m		5.1350m
1.2060m	443.7, 709.21m		6.1620m
1.4070m	517.65, 827.41m		7.1890m
1.6080m	591.6, 945.61m		8.2160m
1.8090m	665.55, 1063.81m		9.2430m
2.0100m	739.5, 1182.01m		10.2700m



LED-NEPTUNE-36P
8031440358057
lumen

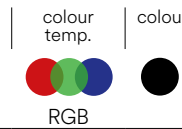

watt $36 \times 1W$
beam angle 45°

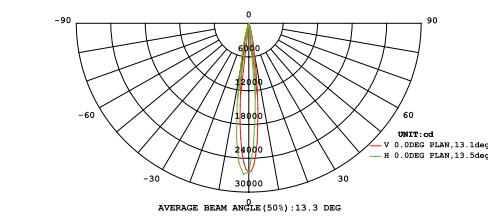
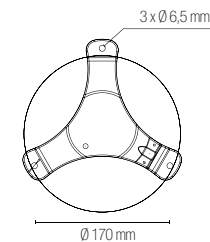
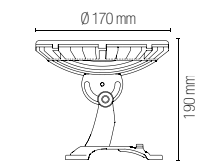

Height	Beam Max	Angle: 45.00deg	Diameter
0.2010m	153.9, 245.70m		0.3360m
0.4020m	307.8, 491.40m		0.6720m
0.6030m	461.7, 737.10m		1.0080m
0.8040m	615.6, 982.80m		1.3440m
1.0050m	769.5, 1228.50m		1.6800m
1.2060m	923.4, 1474.20m		2.0160m
1.4070m	1077.3, 1719.90m		2.3520m
1.6080m	1231.2, 1965.60m		2.6880m
1.8090m	1385.1, 2211.30m		3.0240m
2.0100m	1539, 2457.00m		3.3600m

Materiale
acciaio inox 316

Temperatura colore
RGB full color



Driver
DC24V
non incluso

Durata e on/off
50.000h
>25.000 on/off

Material
316 stainless steel

Colour temperature
RGB full color



Driver
DC24V
not included

Life time and on/off
50.000h
>25.000 on/off

Incasso per fontane LED RGB FULL COLOR.
LED RGB FULL COLOR fountain recess lamp.

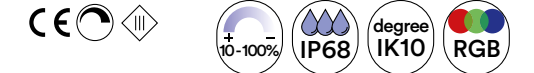

LED-CROWN-R14
8031414869015
lumen

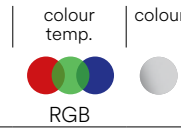

watt $9 \times 2W$
beam angle 25°

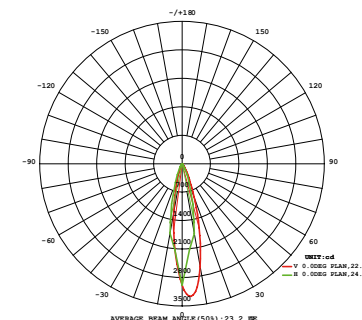
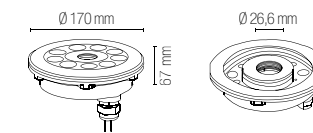

Height	Beam Max	Angle: 25.00deg	Diameter
0.2010m	109.2, 169.16m		0.3600m
0.4020m	218.4, 338.32m		0.7200m
0.6030m	327.6, 507.48m		1.0800m
0.8040m	436.8, 676.64m		1.4400m
1.0050m	546, 845.80m		1.8000m
1.2060m	655.2, 1014.96m		2.1600m
1.4070m	764.4, 1184.12m		2.5200m
1.6080m	873.6, 1353.28m		2.8800m
1.8090m	982.8, 1522.44m		3.2400m
2.0100m	1092, 1691.60m		3.6000m







technical information **TREVIS**



Incasso immersione LED RGB FULL COLOR.
Immersion recessed light LED RGB FULL COLOR.

- Materiale**
acciaio inox 316
- Temperatura colore**
RGB full color
- 
- Driver**
DC 24V
non incluso
- Durata e on/off**
50.000h
>25.000 on/off
- Material**
316 stainless steel
- Colour temperature**
RGB full color
- 
- Driver**
DC 24V
not included
- Life time and on/off**
50.000h
>25.000 on/off





colour temp.	colour	recessed box
RGB		

LED-TREVIS-R7
8031414869022

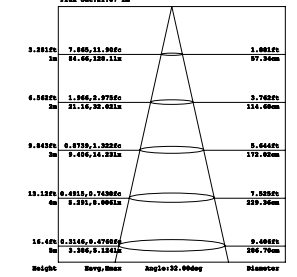
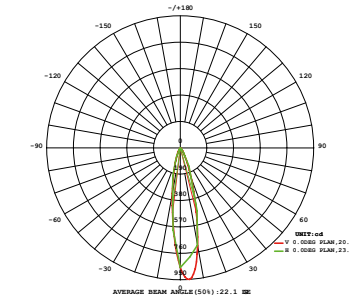
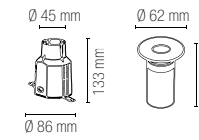
lumen 3W
beam angle 25°



colour temp.	colour	recessed box
RGB		

LED-TREVIS-R11
8031414869039

lumen 9W
beam angle 25°

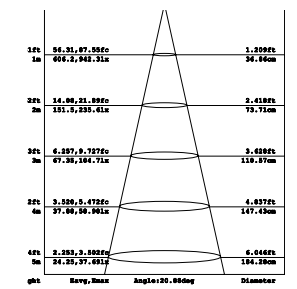
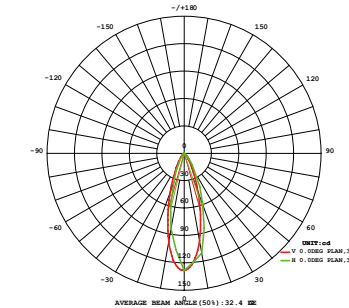
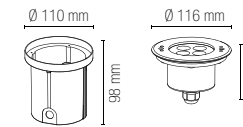

PAR56

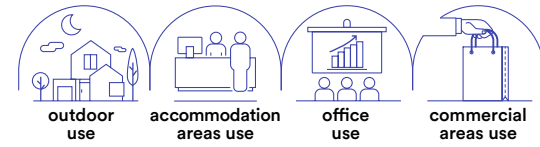

Materiale
policarbonato

Temperatura colore
RGB full color + 5700K



Driver
AC 12V non incluso
DC 24V non incluso

Durata e on/off
50.000h
>25.000 on/off

Material
PC

Colour temperature
RGB full color + 5700K



Driver
AC 12V not included
DC 24V not included

Life time and on/off
50.000h
>25.000 on/off

Incasso LED a immersione per piscine.
Pool immersion LED down light.



LED-PAR56-24V-RGB

8031414879755

lumen

watt

driver

beam angle

1 m cable included

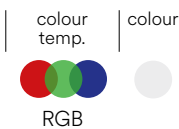

INC-POOL-PAR56

8031440359511

Struttura incasso per PAR 56
per piscine in cemento /
Recessed structure for
PAR56 for concrete swimming pool

1 m cable included

Ø 260 mm

LED-PAR56-BCO

8031440359504

lumen

watt

driver

beam angle

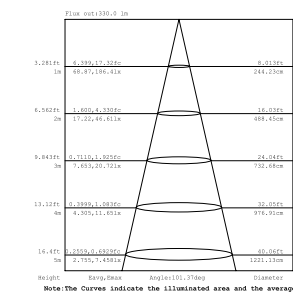
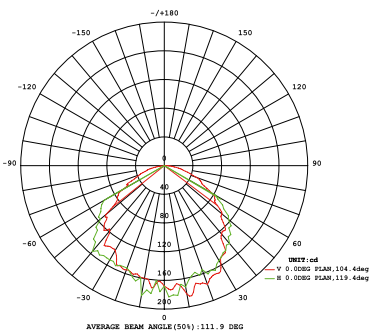
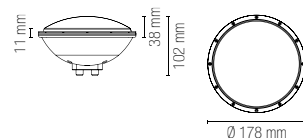
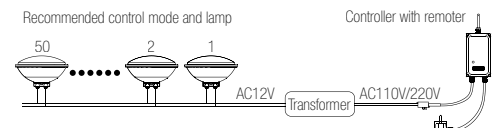
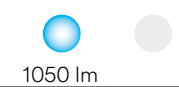

PELPS

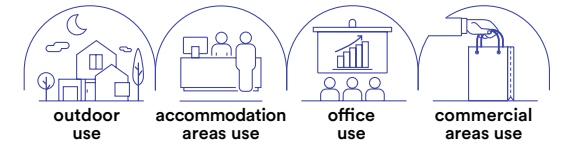

Materiale
policarbonato

Temperatura colore
RGB full color + 5700K



Driver
AC 12V non incluso
DC 24V non incluso

Durata e on/off
50.000h
>25.000 on/off

Material
PC

Colour temperature
RGB full color + 5700K



Driver
AC 12V not included
DC 24V not included

Life time and on/off
50.000h
>25.000 on/off

**Lampada LED per piscine
con fissaggio a parete.**
Pool LED wall lamp.



LED-PELPS24V-RGB

8031414868872

lumen

watt

driver

beam angle

1 m cable included



LED-PELPS-RGB

8031414865406

lumen

watt

driver

beam angle



LED-PELPS-BCO

8031414865420

lumen

watt

driver

beam angle

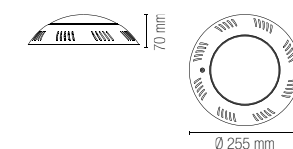
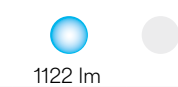

CONTROLLER



CONTROLLER-POOL 8031440359481

Controller 240V
AC MAX 5A/1100W
IP65 distanza max 30M

Controller 240V
AC max 5A/1100W
IP65 max distance 30M

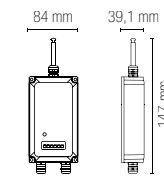
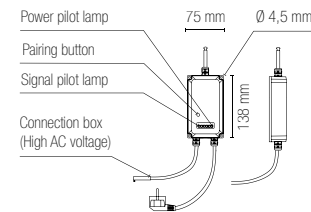

Recommended control mode and lamp

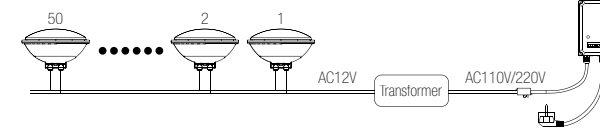

Other control modes and lamps

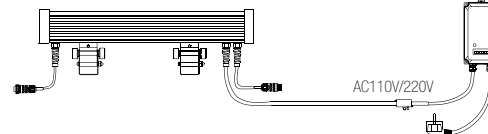

CONTROLLER



CONTROLLER-CTR-RGB 8031440358026

Centralina di comando
C/PORTA DMX512 LED RGB
Input 230V AC
Output DC (12V 144W - 24V 300W)
6 porte da 3 canali RGB

Control box with DMX512
Port for LED RGB
Input 230V AC
Output DC (12V 144W - 24V 300W)
6 ports 3 RGB channels

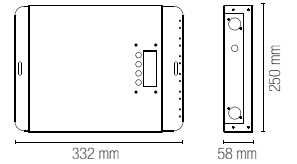

CONTROLLER-CTR-RGB12 8031440355438

Centralina di comando
C/PORTA DMX512 LED RGB
Input 230V AC
Output DC (12V 300W)
6 porte da 3 canali RGB

Control box with DMX512
Port for LED RGB
Input 230V AC
Output DC 12V 300W
6 ports 3 RGB channels

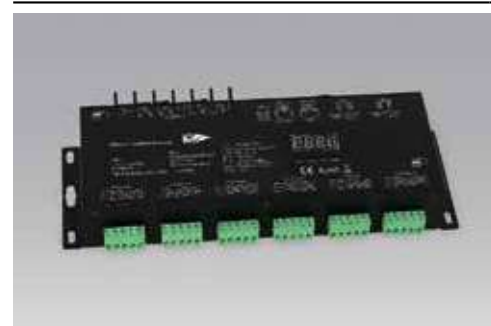
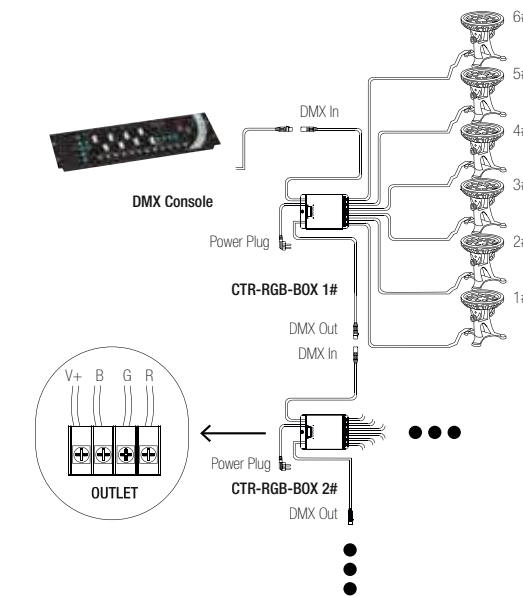

CONTROLLER-DMX-24 8031414872718

Controller DMX 24 canali
Tensione costante 4A
Input VOLTAGE 12/24V DC
Output POWER 24X(48-96)W
Output CURRENT 24X4A

Controller DMX 24 channels
Constant voltage 4A
Input VOLTAGE 12/24V DC
Output POWER 24X(48-96)W
Output CURRENT 24X4A

264,5 × 83 × 42 mm



CONTROLLER-PRO-3 8031440358033

Controller Master 3 canali
per uso proiettori
in modalità EASY
IN 230V OUT DMX/XLR-3
2 canali IP20

Controller Master 3 channels
for flood in EASY MODE
IN 230V OUT DMX/XLR-3
2 channels IP20

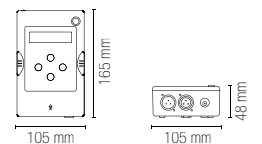

SPLITTER-DMX-4 8031440359542

SPLITTER DMX
6W XLR-3X4PCS XLR-5X4PCS

DMX SPLITTER
6W XLR-3X4PCS XLR-5X4PCS



CONTROLLER-PRO-2 8031440358002

Controller DMX LED
3 canali RGB SEGNALE OUTPUT
DMX/XLR-3 (due uscite)
IP20 con cavo di ricarica

Controller DMX LED
3 channels RGB OUTPUT SIGNAL
DMX/XLR-3 (two port)
IP20 with charge cable

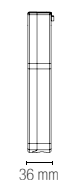
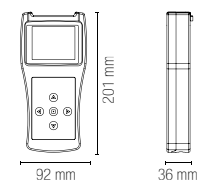
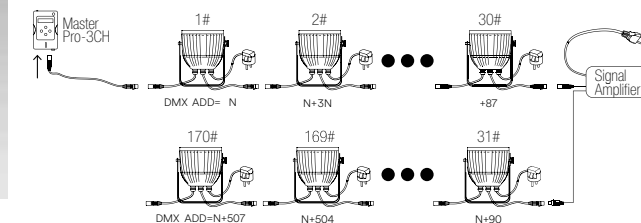

CONTROLLER



LED-SUNLITE-DE3
8031440359498
SUNLITE 2X512 DMX ESA PRO/SUITE 2

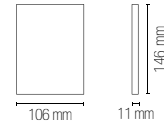

CONTROLLER



LED-SUNLITE-U9
8031440359467
SUNLITE Controller
256 canali Input
(218 steps max)

SUNLITE Controller
256 channels Input
(218 steps max)

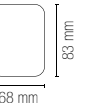





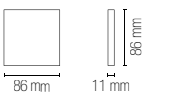





LED-SUNLITE-GU2
8031422251093
SUNLITE DMX STICK-GU2
128 canali Input 240V

SUNLITE DMX STICK-GU2
128 channels Input 240V













COMPONENTISTICA
LIGHTING COMPONENTS

Accessori / Accessories

	TRASFORMATORE-120 8031440355094	IP44	
	Trasformatore di tensione 120W Input 240V AC Output 12V AC IP44 10A	Voltage power supply 120W Input 240V AC Output 12V AC IP44 10A	180 x 134 x 63 mm
	LED-IRIDE-CAVO-2M-2P 8031440355452	IP65	
	Cavo 2 poli per faretto IRIDE bianco alluminio	Cable 2 poles for IRIDE white headlight aluminium	2 metri / 2 meters
	LED-IRIDE-CAVO-2M 8031440358095	IP65	
	Cavo RGB 4 poli per faretto IRIDE RGB bianco alluminio	RGB cable 4 poles for IRIDE RGB white headlight aluminium	2 metri / 2 meters
	CONNETTORE-M 8031440355469	IP68	
	Connettore maschio per DMX	Male connector for DMX	
	CONNETTORE-F 8031440355476	IP68	
	Connettore femmina per DMX	Female connector for DMX	
	CONNECTBOX-IP68-3 8031440358903	IP68	
	Scatola connessione a tre poli	Connection box with three poles	35 x 115 x 71 mm
	CONNECTBOX-IP68-2 8031440358927	IP68	
	Scatola connessione a due poli	Connection box with two poles	30 x 115 x 41 mm
	GUAINA 8031440355483	IP65	
	Guaina isolante	Insulating sheath	
	CONNETTORE-IP20 8031414897681		
	Connettore IP20 2L+2N	IP20 2L+2N Connector	
	CONNETTORE-IP65 8031414897698	IP65	
	Connettore IP65	IP65 Connector	
	CONNETTORE-IP68 8031414897704	IP68	
	Connettore IP68	IP68 Connector	

DRIVER

Driver MINI and LT

	I-DRIVER/4W 8031414862801	IP65	
	MINI Driver corrente costante Output 2-12V 350mA 4W Input 100 ~ 240V	MINI constant current driver Output 2-12V 350mA 4W Input 100 ~ 240V	38 x 27 x 21 mm
	I-DRIVER/4W-24V 8031414871797	IP65	
	MINI Driver corrente costante Output 24V DC 0.17A 4W Input 100 ~ 240V AC 50 ~ 60H	MINI constant voltage driver Output 24V DC 0.17A 4W Input 100 ~ 240V AC 50 ~ 60H	38 x 27 x 21 mm
	I-DRIVER-LT-75-24 8031414876822		
	LT Driver tensione costante Output 24VDC 3.12A 75W Input 220 ~ 240V AC	LT constant voltage driver Output 24VDC 3.12A 75W Input 220 ~ 240V AC	305 x 30 x 17 mm
	I-DRIVER-LT-150-24 8031414876846		
	LT Driver tensione costante Output 24V DC 6.25A 150W Input 220 ~ 240V AC	LT constant voltage driver Output 24V DC 6.25A 150W Input 220 ~ 240V AC	336 x 30 x 17 mm
	I-DRIVER-LT-30-24 8031414896196		
	LT Driver tensione costante Output 24VDC 1.25A 30W Input 220 ~ 240V AC	LT constant voltage driver Output 24VDC 1.25A 30W Input 220 ~ 240V AC	251 x 30 x 16 mm
	I-DRIVER-LT-60-24 8031414896202		
	LT Driver tensione costante Output 24VDC 2.5A 60W Input 220 ~ 240V AC	LT constant voltage driver Output 24VDC 2.5A 60W Input 220 ~ 240V AC	305 x 30 x 18,2 mm
	I-DRIVER-LT-100-24 8031414896226		
	LT Driver tensione costante Output 24VDC 4.17A 100W Input 220 ~ 240V AC	LT constant voltage driver Output 24VDC 4.17A 100W Input 220 ~ 240V AC	312 x 30 x 18,2 mm
	I-DRIVER-LT-200-24 8031414896240		
	LT Driver tensione costante Output 24VDC 8.34A 200W Input 220 ~ 240V AC	LT constant voltage driver Output 24VDC 8.34A 200W Input 220 ~ 240V AC	335 x 30 x 21,6 mm
	I-DRIVER-LT-60-48 8031414896219		
	LT Driver tensione costante Output 48VDC 1.25A 60W Input 220 ~ 240V AC	LT constant voltage driver Output 48VDC 1.25A 60W Input 220 ~ 240V AC	305 x 30 x 18,2 mm
	I-DRIVER-LT-150-48 8031414896233		
	LT Driver tensione costante Output 48VDC 3.125A 150W Input 220 ~ 240V AC	LT constant voltage driver Output 48VDC 3.125A 150W Input 220 ~ 240V AC	335 x 30 x 21,6 mm

ALIMENTATORI POWER SUPPLY

Alimentatori tensione costante LRS e RSP 12V /
Costant voltage power supply LRS and RSP 12V



STRIP-DRIVER12V-35W
8031440360265

Output 12V 3A 36W
Input 85 ~ 264VAC 120 ~ 373VDC

99 × 82 × 30 mm



STRIP-DRIVER12V-50W
8031414866779

Output 12V 4.2A 50W
Input 85 ~ 264VAC 120 ~ 373VDC

99 × 82 × 30 mm



STRIP-DRIVER12V-75W
8031439581268

Output 12V 6A 72W
Input 85 ~ 264VAC 120 ~ 373VDC

99 × 97 × 30 mm



STRIP-DRIVER12V-100W
8031440359368

Output 12V 8.5A 102W
Input 85 ~ 264VAC 120 ~ 373VDC

129 × 97 × 30 mm



STRIP-DRIVER12V-150W
8031439611262

Output 12V 12.5A 150W
Input 85 ~ 132VAC / 170 ~ 264VAC
by switch
240 ~ 370VDC (switch on 230VAC)

159 × 97 × 30 mm



STRIP-DRIVER12V-200W
8031440359375

Output 12V 16.7A 200W
Input 85 ~ 264VAC 124 ~ 370VDC

215 × 115 × 30 mm



STRIP-DRIVER12V-320W
8031440359344

Output 12V 26.7A 320W
Input 88 ~ 264VAC 124 ~ 370VDC

215 × 115 × 30 mm

ALIMENTATORI POWER SUPPLY

Alimentatori tensione costante LRS e RSP 24V /
Costant voltage power supply LRS and RSP 24V



STRIP-DRIVER24V-35W
8031414870943

Output 24V 1,5A 36W
Input 85 ~ 264VAC 120 ~ 373VDC

99 × 82 × 30 mm



STRIP-DRIVER24V-50W
8031440364744

Output 24V 2,2A 52W
Input 85 ~ 264VAC 120 ~ 373VDC

99 × 82 × 30 mm



STRIP-DRIVER24V-75W
8031414870950

Output 24V 3,2A 76W
Input 85 ~ 264VAC 120 ~ 373VDC

99 × 97 × 30 mm



STRIP-DRIVER24V-100W
8031440364751

Output 24V 4,5A 108W
Input 85 ~ 264VAC 120 ~ 373VDC

129 × 97 × 30 mm



STRIP-DRIVER24V-150W
8031414870967

Output 24V 6,5A 156W
Input 85 ~ 132VAC / 170 ~ 264VAC
by switch
240 ~ 370VDC (switch on 230VAC)

159 × 97 × 30 mm



STRIP-DRIVER24V-200W
8031440364737

Output 24V 8,4A 201W
Input 85 ~ 264VAC 124 ~ 370VDC

215 × 115 × 30 mm



STRIP-DRIVER24V-320W
8031414864959

Output 24V 13,4A 321W
Input 88 ~ 264VAC 124 ~ 370VDC

215 × 115 × 30 mm

ALIMENTATORI POWER SUPPLY

		I-Driver-UHP-200-24 8031414896387 Output 24V 8.4A 200W Input 90 ~ 264VAC 127 ~ 370VDC	194 × 55 × 26 mm
Alimentatori tensione costante UHP 24V / Costant voltage power supply UHP 24V		I-Driver-UHP-350-24 8031414879618 Output 24V 14.6A 350W Input 90 ~ 264VAC 127 ~ 370VDC	220 × 62 × 31 mm
	senza ventola / without fan		
		I-Driver-UHP-500-24 8031414879625 Output 24V 20.9A 501W Input 90 ~ 264VAC 127 ~ 370VDC	220 × 62 × 31 mm
		STRIP-DRIVER36V-200W 8031414870974 Output 36V 5.56A 200W Input 88 ~ 264VAC 124 ~ 370VDC	215 × 115 × 30 mm
Alimentatori tensione costante RSP 36V / Costant voltage power supply RSP 36V		STRIP-DRIVER36V-320W 8031414864829 Output 36V 8.9A 320W Input 88 ~ 264VAC 124 ~ 370VDC	215 × 115 × 30 mm
		STRIP-DRIVER48V-75W 8031414881536 Output 48V 1.6A 76,8W Input 88 ~ 264VAC 124 ~ 370VDC	99 × 97 × 30 mm
Alimentatori tensione costante RSP 48V / Costant voltage power supply RSP 48V		STRIP-DRIVER48V-150W 8031414881529 Output 48V 3.3A 158,4W Input 85 ~ 132VAC 240 ~ 370VDC	159 × 97 × 30 mm
		STRIP-DRIVER48V-200W 8031414878307 Output 48V 4.2A 201W Input 88 ~ 264VAC 124 ~ 370VDC	215 × 115 × 30 mm
		STRIP-DRIVER48V-320W 8031414878314 Output 48V 4.2A 201W Input 88 ~ 264VAC 124 ~ 370VDC	215 × 115 × 30 mm

DRIVER

Driver LPHC LPH and LCM

	I-Driver/18W-24V 8031414875351 LPH Output 24V 0.75A 18W Input 180 ~ 264VAC 254 ~ 370VDC	 IP67	140 × 30 × 22 mm
	I-Driver/18W 8031439571269 LPHC Output 6~48V 350mA 16,8W Input 180 ~ 264VAC	 IP67	140 × 30 × 22 mm
	I-Driver-DIMM-LCM40 8031439591267 LCM dimmable 42W Output DC 2~100V 350mA; 2~80V 500mA; 2~67V 600mA; 2~57V 700mA; 2~45V 900mA; 2~40V 1050mA Input 180 ~ 295VAC 254~417VDC	 IP67	123,5 × 81,5 × 23 mm
	I-Driver-DIMM-LCM60 8031439561260 LCM dimmable 60W Output DC 2~90V 500mA; 2~90V 600mA; 2~86V 700mA; 2~67V 900mA; 2~57V 1050mA; 2~42V 1400mA Input 180 ~ 295VAC 254~417VDC	 IP67	123,5 × 81,5 × 23 mm

DRIVER

Driver HLG IP67 12-24V

	I-Driver-HLG-120-12 8031440360272 Output 12V 10A 120W Input 90 ~ 305VAC 127 ~ 431VDC	 IP67	220 × 68 × 38,8 mm
	I-Driver-HLG-120-24 8031440360241 Output 24V 5A 120W Input 90 ~ 305VAC 127 ~ 431VDC	 IP67	220 × 68 × 38,8 mm
	I-Driver-HLG-320-12 8031440360258 Output 12V 22A 264W Input 90 ~ 305VAC 127 ~ 431VDC	 IP67	252 × 90 × 43,8 mm
	I-Driver-HLG-320-24 8031440360227 Output 24V 13.34A 320W Input 90 ~ 305VAC 127 ~ 431VDC	 IP67	252 × 90 × 43,8 mm

DRIVER

Driver ELG 24V IP67 dimmerabili e LPV 24V IP67 / Dimmable driver ELG 24V IP67 and LPV 24V IP67

	I-DRIVER-ELG-100-24 8031414876914		199 × 63 × 35,5 mm
	ELG Dimmable Output 24V 4A 100W Input 100 ~ 305VAC 142 ~ 431VDC continue 320VAC for 24Hrs; 360VAC for 1Hr		
	I-DRIVER-ELG-100-24DA  8031414876921		199 × 63 × 35,5 mm
	ELG Dimmable DALI Output 24V 4A 100W Input 100 ~ 305VAC 142 ~ 431VDC continue 320VAC for 24Hrs; 360VAC for 1Hr		
	I-DRIVER-ELG-150-24 8031414876891		219 × 63 × 35,5 mm
	ELG Dimmable Output 24V 6.25A 150W Input 100 ~ 305VAC 142 ~ 431VDC		
	I-DRIVER-ELG-150-24DA  8031414876907		219 × 63 × 35,5 mm
	ELG Dimmable DALI Output 24V 6.25A 150W Input 100 ~ 305VAC 142 ~ 431VDC		
	I-DRIVER-ELG-240-24 8031414876877		244 × 71 × 37,5 mm
	ELG Dimmable Output 24V 10A 240W Input 100 ~ 305VAC 142 ~ 431VDC		
	I-DRIVER-ELG-240-24DA  8031414876884		244 × 71 × 37,5 mm
	ELG Dimmable DALI Output 24V 10A 240W Input 100 ~ 305VAC 142 ~ 431VDC		
	I-DRIVER-LPV-60-24 8031414876839		162,5 × 42,5 × 32 mm
	LPV Output 24V 2.5A 60W Input 90 ~ 264VAC 127 ~ 370VDC		
	I-DRIVER-LPV-100-24 8031414876853		190 × 52 × 37 mm
	LPV Output 24V 4.2A 100W Input 90 ~ 264VAC 127 ~ 370VDC		
	I-DRIVER-LPV-150-24 8031414876860		191 × 63 × 37,5 mm
	LPV Output 24V 6.3A 150W Input 180 ~ 305VAC 254 ~ 431VDC		









DRIVER

Driver XLG 24V IP67

	I-DRIVER-XLG-75-24 8031414873708		140 × 63 × 32 mm
	Output 24V 3.1A 75W Input 100 ~ 305VAC 142 ~ 431VDC		
	I-DRIVER-XLG-100-24 8031414879595		140 × 63 × 32 mm
	Output 24V 4A 100W Input 100 ~ 305VAC 142 ~ 431VDC		
	I-DRIVER-XLG-150-24 8031414879601		180 × 63 × 35,5 mm
	Output 24V 6.25A 150W Input 100 ~ 305VAC 142 ~ 431VDC		
	I-DRIVER-XLG-200-24 8031414879588		199 × 63 × 35,5 mm
	Output 24V 8.3A 200W Input 100 ~ 305VAC 142 ~ 431VDC		



DRIVER

Driver PWM DALI2

	I-DRIVER-PWM-60-24DA  8031414896356		150 × 53 × 35 mm
	Output 24V 2.5A 60W Input 90 ~ 305VAC 127 ~ 431VDC DALI2		
	I-DRIVER-PWM-120-24DA  8031414896363		191 × 63 × 37,5 mm
	Output 24V 5A 120W Input 90 ~ 305VAC 127 ~ 431VDC DALI2		
	I-DRIVER-PWM-200-24DA  8031414896370		195 × 68 × 39,5 mm
	Output 24V 8.3A 200W Input 100 ~ 305VAC 142 ~ 431VDC DALI2		





DRIVER

Guida DIN a forma di gradino ultra sottile / Ultra Slim Step Shape DIN Rail

	I-DRIVER-HDR-60-24 8031414896271 Output 24V 2.5A 60W Input 85 ~ 264VAC (277VAC operational) 120 ~ 370VDC (390VAC operational)	52,5 × 90 × 54,5 mm
	I-DRIVER-HDR-100-24 8031414896288 Output 24V 3.83A 100W Input 85 ~ 264VAC (277VAC operational) 120 ~ 370VDC (390VAC operational)	70 × 90 × 54,5 mm
	I-DRIVER-HDR-150-24 8031414896295 Output 24V 6.25A 150W Input 85 ~ 264VAC (277VAC operational) 120 ~ 370VDC (390VAC operational)	105 × 90 × 54,5 mm

DRIVER

Guida DIN industriale a uscita singola / Single Output Industrial DIN RAIL



	I-DRIVER-NDR-240-24 8031414896301 Output 24V 10A 240W Input 90 ~ 264VAC 127 ~ 370VDC	63 × 125,2 × 113,5 mm
	I-DRIVER-NDR-480-24 8031414896325 Output 24V 20A 480W Input 90 ~ 264VAC 127 ~ 370VDC	85,5 × 125,2 × 128,5 mm
	I-DRIVER-NDR-240-48 8031414896318 Output 48V 5A 240W Input 90 ~ 264VAC 127 ~ 370VDC	63 × 125,2 × 113,5 mm
	I-DRIVER-NDR-480-48 8031414896332 Output 48V 10A 480W Input 90 ~ 264VAC 127 ~ 370VDC	85,5 × 125,2 × 128,5 mm

DRIVER

Guida DIN industriale a uscita singola con funzione PFC / Single Output Industrial DIN RAIL with PFC Function



	I-DRIVER-SDR-960-24 8031414896349 Output 24V 40A 960W Input 180 ~ 264VAC 254 ~ 370VDC	110 × 125,2 × 150 mm
---	---	----------------------

DIMMER















	I-DIMMER-D1-10 8031414877959 D1-10 dimmer Dimming range 1%-100% 1-10V 40mA	D1-10 dimmer Dimming range 1%-100% 1-10V 40mA	22,5 × 22,5 × 48,6 mm
	I-DIMMER-D1-10S 8031414896257 D1-10 dimmer Dimming range 1%-100% 1-10V 40mA	D1-10 dimmer Dimming range 1%-100% 1-10V 40mA	83,5 × 83,5 × 44 mm
	I-DIMMER-D350S 8031414896264 Dimmer a taglio di fase 220~240VAC 10~350W 1.5A	Trailing edge dimmer 220~240VAC 10~350W 1.5A	83,5 × 83,5 × 44 mm

DRIVER

Driver emergenza / Emergency driver

	I-DRIVER-EMERGENCY 8031414864751 Driver di emergenza 6-60V 400-40mA 4W 180Min Batteria 3,6V 3.0Ah Ni-Cd	Emergency driver 6-60V 400-40mA 4W 180Min Batteria 3,6V 3.0Ah Ni-Cd	160 × 38 × 28 mm
	I-DRIVER-HELP 8031414862559 Driver di emergenza Output Voltage 10-120V Input Voltage 85-265V 3-40W. emergenza 120 min. 18650 Li-Ion Battery 3,7V 2.4Ah	Emergency driver Output Voltage 10-120V Input Voltage 85-265V 3-40W. emergency 120 min. 18650 Li-Ion Battery 3,7V 2.4Ah	131 × 55 × 21 mm
	I-DRIVER-HELP-HV 8031414882595 Emergency output voltage 230V AC, adatto per: 2,5W emergency power 3 hours emergency time 3,5W emergency power 2 hours emergency time 5W emergency power 1,5 hours emergency time Battery 18650 LiFePO4 6.4V 1500mAh	Emergency output voltage 230V AC, suitable for: 2,5W emergency power 3 hours emergency time 3,5W emergency power 2 hours emergency time 5W emergency power 1,5 hours emergency time Battery 18650 LiFePO4 6.4V 1500mAh	160 × 38 × 28 mm

DRIVER

	I-DRIVER-60-24 8031414897797 Output 24V 2.5A 60W Input 176 ~ 264VAC 176~370VDC		178 × 53 × 23 mm
	I-DRIVER-60-24-IP67 8031414897841 Output 24V 2.5A 60W Input 176 ~ 264VAC		160 × 50 × 31 mm
	I-DRIVER-100-24 8031414897803 Output 24V 4.1A 100W Input 176 ~ 264VAC 250 ~ 360VDC		188 × 53 × 23 mm
	I-DRIVER-100-24-IP67 8031414897858 Output 24V 4.2A 100W Input 176 ~ 264VAC		220 × 50 × 31 mm
	I-DRIVER-150-24 8031414897810 Output 24V 6.3A 150W Input 175 ~ 264VAC 176 ~ 370VDC		220 × 53 × 23 mm
	I-DRIVER-150-24-IP67 8031414897865 Output 24V 6.25A 150W Input 176 ~ 264VAC		230 × 65 × 21 mm
	I-DRIVER-200-24 8031414897827 Output 24V 8.3A 200W Input 175 ~ 264VAC 175 ~ 370VDC		274 × 53 × 23 mm
	I-DRIVER-200-24-IP67 8031414897872 Output 24V 8.3A 200W Input 175 ~ 264VAC		230 × 65 × 31 mm
	I-DRIVER-300-24 8031414897834 Output 22-24V 11.5A 300W Input 175 ~ 264VAC 175 ~ 370VDC		230 × 65 × 31 mm
	I-DRIVER-DELO42 8031414897667 Output 6-38/40/42 VDC 0.45-1.10A 42W Input 220 ~ 240VAC DALI2 PUSH DIM		103 × 68,5 × 30,5 mm

DIMMER

	STRIP-CONTROL-WIFI 8031440359474 Kit controller + radiocomando 2.4G per prodotti LED RGBW DC 12/24V 6Ax3ch Max Distanza 20 m	Controller + 2.4G remote control kit for LED RGBW items DC 12/24V 6Ax3ch Max distance 20 m	81 × 84 × 32 mm
	STRIP-SOUND 8031434531213 Ricevitore musicale + telecomando RGB 12V per strip LED	Musical control receiver RGB 12V for strip LED + remote control	50 × 70 × 20 mm
ADATTATORI POWER SUPPLY Adattatore tensione costante / Costant voltage power supply			
	STRIP-ADAT-12W 8031433141208 12V 12W - Spina CEE 7/16 IP20 Output 12V 1A Input 110-240V 0,5A IP20 - CLASSE 2		38 × 67 × 42 mm cavo/cable 1500 mm
	STRIP-ADAT-24W 8031433251204 12V 24W - Spina CEE 7/16 IP20 Output 12V 2A Input 110-240V 0,6A IP20 - CLASSE 2		38 × 80 × 50 mm cavo/cable 1500 mm
	STRIP-ADAT-36W 8031436601235 LED 12V 36W - Spina CEE 7/16 IP20 Output 12V 3A Input 110-240V 0,6A IP20 - CLASSE 2		35 × 100 × 50 mm cavo/cable 1500 mm

REMOTE CONTROL

	RF-WALLPAD-1CH 8031414876426	Wallpad RF 2.4G controllo dimmer-varialuce 4 zone 1 canale 2xAAA non include	RF 2.4G wallpad dimming light 4 zone 1 channel 2xAAA not included	86 × 86 × 36,5 mm
	RF-WALLPAD-2CH 8031414876433	Wallpad RF 2.4G controllo CCT bianco dinamico 4 zone 2 canali 2xAAA non include	RF 2.4G wallpad CCT adjustable white 4 zone 2 channels 2xAAA not included	86 × 86 × 36,5 mm
	RF-WALLPAD-5CH 8031414876440	Wallpad RF 2.4G controllo RGB/RGBW/RGB+CCT 4 zone 5 canali 2xAAA non include	RF 2.4G wallpad RGB/RGBW/RGB+CCT 4 zone 5 channels 2xAAA not included	86 × 86 × 36,5 mm
	RF-DMXPAD-1CH 8031414876457	Wallpad RF 2.4G controllo dimmer-varialuce 4 zone 1 canale 230V collegabile con protocollo DMX 512	RF 2.4G wallpad dimming light 4 zone 1 channel 230V linkable with DMX512 protocol	120 × 80 × 37 mm formato universale per cassetta 503 / universal size for 503 box
	RF-DMXPAD-2CH 8031414876464	Wallpad RF 2.4G controllo CCT bianco dinamico 4 zone 2 canali 230V collegabile con protocollo DMX 512	RF 2.4G wallpad CCT adjustable white 4 zone 2 channels 230V collegabile con protocollo DMX 512	120 × 80 × 37 mm formato universale per cassetta 503 / universal size for 503 box
	RF-DMXPAD-5CH 8031414876471	Wallpad RF 2.4G controllo RGB/RGBW/RGB+CCT 4 zone 5 canali 230V collegabile con protocollo DMX 512	RF 2.4G wallpad RGB/RGBW/RGB+CCT 4 zone 5 channels 230V collegabile con protocollo DMX 512	120 × 80 × 37 mm formato universale per cassetta 503 / universal size for 503 box









REMOTE CONTROL

	RF-COM-1CH 8031414876402	Radiocomando RF 2.4G controllo dimmer-varialuce 4 zone 1 canale 2xAAA non include	RF 2.4G remote control dimming light 4 zone 1 channel 2xAAA not included
	RF-COM-2CH 8031414876396	Radiocomando RF 2.4G controllo CCT bianco dinamico 4 zone 2 canali 2xAAA non include	RF 2.4G remote control CCT adjustable white 4 zone 2 channels 2xAAA not included
	RF-COM-5CH 8031414876419	Radiocomando RF 2.4G controllo RGB/RGBW/RGB+CCT 4 zone 5 canali 2xAAA non include	RF 2.4G remote control CCT adjustable white 4 zone 2 channels 2xAAA not included
	RF-COM-5CH-1ZN 8031414897919	Controllo RGB+CCT 1 zone Batteria CR2032	RGB+CCT Remote Control 1 zone Battery CR2032
	RF-COM-1CH-1ZN 8031414897896	Controllo luminosità 1 zone Batteria CR2032	Brightness Remote Control 1 zone Battery CR2032
	RF-COM-2CH-1ZN 8031414897902	Controllo CCT 1 zone Batteria CR2032	CCT Remote Control 1 zone Battery CR2032
	RF-COM-5CH-8ZN 8031414897926	Radiocomando RF 2.4G controllo RGB/RGBW/RGB+CCT 8 zone	8 scene 2xAAA non include RF Remote Controller 8 zones 8 scenes Battery: 2xAAA not included

REMOTE CONTROL

	RF-RICEVITORE-1CH 8031414897933 Ricevitore RF 2.4G 1 canale per WALLPAD RADIOCOMANDO WALLPAD DMX utilizzabile per SINGOLO COLORE Input 8.5A 12-24V Output 1CH 8A - 40W/96W/192W/288W	RF 2.4G receiver box 2 channels for WALLPAD RADIOCOMANDO WALLPAD DMX usable for SINGLE COLOR Input 8.5A 12-24V Output 1CH 8A - 40W/96W/192W/288W	97 × 33 × 18 mm
	RF-RICEVITORE-2CH 8031414876488 Ricevitore RF 2.4G 2 canali per WALLPAD RADIOCOMANDO WALLPAD DMX utilizzabile per SINGOLO COLORE/CCT Input 10.5A 12-24V Output 2CH;5A/CH - 2x(60-120)W	RF 2.4G receiver box 2 channels for WALLPAD RADIOCOMANDO WALLPAD DMX usable for SINGLE COLOR/CCT Input 10.5A 12-24V Output 2CH;5A/CH - 2x(60-120)W	97 × 33 × 18 mm
	RF-RICEVITORE-5CH 8031414876495 Ricevitore RF 2.4G 5 canali per WALLPAD RADIOCOMANDO WALLPAD DMX utilizzabile per SINGOLO COLORE/CCT/RGB/RGBW/RGB+CCT Input 15.5A 12-24V Output 5CH;3A/CH - 5x(36-72)W	F 2.4G receiver box 5 channels for WALLPAD RADIOCOMANDO WALLPAD DMX usable for SINGLE COLOR/CCT/RGB/RGBW/RGB+CCT Input 15.5A 12-24V Output 5CH;3A/CH - 5x(36-72)W	114 × 38 × 20 mm
	RF-RICEVITORE-5CH-PRO 8031414882724 Ricevitore RF 2.4G 5 canali per WALLPAD RADIOCOMANDO WALLPAD DMX utilizzabile per SINGOLO COLORE/CCT/RGB/RGBW/RGB+CCT Input 30.5A 12-48V Output 5CH;6A/CH 12/24V 5 x (72-144)W 5CH;4A/CH 36/48V - 5x(144-192)W	RF 2.4G receiver box 5 channels for WALLPAD RADIOCOMANDO WALLPAD DMX usable for SINGLE COLOR /CCT/RGB/RGBW/RGB+CCT Input 30.5A 12-48V Output 5CH;6A/CH 12/24V 5x(72-144)W 5CH;4A/CH 36/48V - 5x(144-192)W	 179 × 56 × 30 mm
	RF-RICEVITORE-4CH-IP67 8031414882717 Ricevitore RF 2.4G 4 canali per WALLPAD RADIOCOMANDO WALLPAD DMX utilizzabile per SINGOLO COLORE/CCT/RGB/RGBW Input 20.5A 12-36V Output 4CH;5A/CH - 4x(60-180)W	RF 2.4G receiver box 4 channels for WALLPAD RADIOCOMANDO WALLPAD DMX usable for SINGLE COLOR /CCT/RGB/RGBW Input 20.5A 12-36V Output 4CH;5A/CH - 4x(60-180)W	176 × 78 × 38 mm

REMOTE CONTROL

	RF-WIFI-CONTROL-5CH 8031414878710 Ricevitore Wi-Fi + RF 2.4G 5 canali per WALLPAD RADIOCOMANDO WALLPAD DMX utilizzabile per SINGOLO COLORE/CCT/RGB/RGBW/RGB+CCT Input 15.5A 12-24V Output 5CH;3A/CH - 5x(36-72)W	Wi-Fi + RF 2.4G receiver box 5 channels for WALLPAD RADIOCOMANDO WALLPAD DMX usable for SINGLE COLOR /CCT/RGB/RGBW/RGB+CCT Input 15.5A 12-24V Output 5CH;3A/CH - 5x(36-72)W	114 × 38 × 20 mm	
	RF-BT-CONTROL-5CH 8031414878826 Ricevitore Bluetooth + RF 2.4G 5 canali per WALLPAD RADIOCOMANDO WALLPAD DMX utilizzabile per SINGOLO COLORE/CCT/RGB/RGBW/RGB+CCT Input 15.5A 12-24V Output 5CH;3A/CH - 5x(36-72)W	Bluetooth + RF 2.4G receiver box 5 channels for WALLPAD RADIOCOMANDO WALLPAD DMX usable for SINGLE COLOR /CCT/RGB/RGBW/RGB+CCT Input 15.5A 12-24V Output 5CH;3A/CH - 5x(36-72)W	114 × 38 × 20 mm	
	RF-AMPLIFICATORE-5CH 8031414882700 Amplificatore 5 canali Input 25.5A 12-24VDC Output 5CH;5A/ CH 12/24V - 5x(60-120)W	5 Channel amplifier Input 25.5A 12-24VDC Output 5CH;5A/ CH 12/24V - 5x(60-120)W	107 × 75 × 24,5 mm	
	RF-AMPLIFICATORE-2CH 8031414882694 Amplificatore 2 canali Input 16.5A 12-36VDC Output 2CH;8A/ CH 12/36V - 2x(96-288)W	2 Channel amplifier Input 16.5A 12-36VDC Output 2CH;8A/ CH 12/36V - 2x(96-288)W	175 × 45 × 27 mm	
	RF-RIPETITORE 8031414882731 Ripetitore di segnale RF 2.4G AC100-240V DC12-24V	RF 2.4G signal Repeater AC100-240V DC12-24V	52 × 52 × 26 mm	
	STRIP-AMPLIFIER-5C 8031414871858 5 Canali DC12-24V Output Current < 3A/Ch (5 Channel) Output Power: 12V <180W; 24V<360W	5 Channel DC12-24V Output Current < 3A/Ch (5 Channel) Output Power: 12V <180W; 24V<360W	81 × 64 × 25 mm	

AMPLIFICATORE AMPLIFIER

Amplificatore segnale /
Signal amplifier











CLAY

Prodotti in porcellana e cavi elettrici a treccia / Porcelain products and braid cables

	I-CLAY-SCADER 8031414865031 Scatola di derivazione elettrica CLAY in porcellana bianca	White porcelain external junction box CLAY	Ø 80 x H 45 mm
	I-CLAY-INTERRUTTORE 8031414865048 Interruttore rotativo CLAY in porcellana bianca 10A AC230V 50Hz	White porcelain rotating switch CLAY 10A AC230V 50Hz	Ø 65 x H 60 mm
	I-CLAY-PRESA 8031414865055 Presca elettrica CLAY polivalente in porcellana bianca 10/16A AC230V 50Hz	White porcelain universal socket CLAY 10/16A AC230V 50Hz	Ø 65 x H 37 mm
	I-CLAY-PRESA-F 8031414865062 Presca elettrica Schuko CLAY in porcellana bianca	White porcelain Schuko socket CLAY	Ø 65 x H 50 mm
	I-CLAY-E27 8031414871117 Portalampada CLAY in porcellana bianca E27 AC230V 50Hz	White porcelain E27 lamp-holder AC230V 50Hz	Ø 45 x H 60 mm
	I-CLAY-E14 8031414870929 Portalampada CLAY in porcellana bianca E14 AC230V 50Hz	White porcelain E14 lamp-holder AC230V 50Hz	Ø 35 - H 60 mm
	I-CLAY-BASE 8031414870936 Rosone in porcellana bianca	White porcelain canopy	Ø 105 x H 30 mm
	I-CLAY-ISOLATORI 8031414865079 Kit 4 pz isolatori CLAY in porcellana bianca	White porcelain pulleys CLAY set 4 pcs	Ø 18 x H 20 mm

CLAY

Prodotti in porcellana e cavi elettrici a treccia / Porcelain products and braid cables

	I-CLAY-CAVO-BCO 8031414865086 Cavo elettrico CLAY trecciato con rivestimento tessile bianco	Twisted white fabric wire CLAY	5 m 3 x 0,75 mm
	I-CLAY-CAVO-2P-BCO 8031414865277 Cavo elettrico CLAY trecciato con rivestimento tessile bianco	Twisted white fabric wire CLAY	5 m 2 x 0,75 mm
	I-CLAY-CAVO-R25 BCO 8031414871162 Cavo elettrico CLAY trecciato con rivestimento tessile bianco	Twisted white fabric wire CLAY	25 m 2 x 0,75 mm
	I-CLAY-CAVO-ORO 8031414865093 Cavo elettrico CLAY trecciato con rivestimento tessile in oro	Gold twisted fabric wire CLAY	5 m 3 x 0,75 mm
	I-CLAY-CAVO-2P-ORO 8031414865284 Cavo elettrico CLAY trecciato con rivestimento tessile oro	Gold twisted fabric wire CLAY	5 m 2 x 0,75 mm
	I-CLAY-CAVO-R25 ORO 8031414871131 Cavo elettrico CLAY trecciato con rivestimento tessile oro	Gold twisted fabric wire CLAY	25 m 2 x 0,75 mm
	I-CLAY-CAVO-R25 MAR 8031414871148 Cavo elettrico CLAY trecciato con rivestimento tessile marrone	Brown twisted fabric wire CLAY	25 m 3 x 0,75 mm
	I-CLAY-CAVO3X1,5 BCO 8031414877980 Cavo elettrico CLAY trecciato con rivestimento tessile bianco	White twisted fabric wire CLAY	25 m 3 x 1,5 mm
	I-CLAY-CAVO3X1,5 MAR 8031414878000 Cavo elettrico CLAY trecciato con rivestimento tessile in marrone	Brown twisted fabric wire CLAY	25 m 3 x 1,5 mm
	I-CLAY-CAVO3X1,5 ORO 8031414877997 Cavo elettrico CLAY trecciato con rivestimento tessile in oro	Gold twisted fabric wire CLAY	25 m 3 x 1,5 mm

PORTALAMPADE LAMP HOLDERS

Accessori / Accessories









	I-PORTALAMPADE-E14-L 8031440354592 Portalampada E14 con copertura liscia in PET	E14 lamp holder with smooth PET cover
	I-PORTALAMPADE-E14-S 8031440354578 Portalampada E14 in PET con copertura filettata e ghiera	E14 PET lamp holder with cover threaded and ring
	I-PORTALAMPADE-E14-T 8031440354585 Portalampada E14 in PET con copertura mezza filettata con ghiera	E14 PET lamp holder with half threaded
	I-PORTALAMPADE-E27-L 8031440354554 Portalampada E27 con copertura liscia in PET	E27 lamp holder with smooth PET cover
	I-PORTALAMPADE-E27-P 8031440354561 Portalampada E27 in PBT	E27 lamp holder in PBT
	I-PORTALAMPADE-E27-S 8031440354530 Portalampada E27 in PET con copertura filettata e ghiera	E14 PET lamp holder with cover threaded and ring
	I-PORTALAMPADE-E27-T 8031440354547 Portalampada E27 in PET con copertura mezza filettata con ghiera	E14 PET lamp holder with half threaded
	I-PORTALAMPADE-GU10 8031435751221 Portalampada GU10 in PBT con cavo di 12 cm	GU10 lamp holder in PBT with 12 cm cable

PORTALAMPADE LAMP HOLDERS

Accessori / Accessories

	I-PORTALAMPADE-MR16 8031439761264 Portalampada MR16 in PBT con cavo di 10 cm	Lamp holder MR16 in PBT with 10 cm cable
	I-PORTALAMPADE-T8 8031439851262 Portalampada T8 in PBT fissaggio a clip	Lamp holder T8 in PBT clip fixing
	I-PORTALAMPADE-R7S 8031414861491 Portalampada R7S 118 mm in PBT incluso filo da 15 cm	Lamp holder R7S 118 mm in PBT including 15 cm wire
	I-PORTALAMPADE-G9 8031414862962 Portalampada G9 in PBT con cavo di 10 cm	Lamp holder G9 in PBT with 10 cm cable
	INC-MATRIX-KIT 8031436551233 Kit molle e anello per farette incasso GU10	Kit springs and ring for recessed spotlights GU10
	CABLAGGIO 8031414865499 Cabl. trip. cavo tondo bianco H05VV-F spina Italia 10A, 250V	White round cable harness H05VV-F plug Italy 10A, 250V 2,5 m 3 x 0,75 mm

ADATTATORI LAMPHOLDER ADAPTERS

	ADATTATORE-E14-E27 8031439351267 Adattatore da E14 a E27 in PET	Lamp holder adapter from E14 to E27 in PET
	ADATTATORE-E27-E14 8031439391263 Adattatore da E27 a E14 in PET	Lamp holder adapter from E27 to E14 in PET
	ADATTATORE-E27-2E27 80314439371265 Adattatore da E27 a 2 E27 in PET	Lamp holder adapter from E27 to E27 in PET
	ADATTATORE-E27-GU10 8031436171233 Adattatore da E27 a GU10 in PET	Lamp holder adapter from E27 to GU10 in PET
	ADATTATORE-E14-GU10 8031439361266 Adattatore da E14 a GU10 in PET	Lamp holder adapter from E14 to GU10 in PET
	ADATTATORE-GU10-E14 8031439431266 Adattatore da GU10 a E14 in PET	Lamp holder adapter from GU10 to E14 in PET
	ADATTATORE-GU10-E27 8031439421267 Adattatore da GU10 a E27 in PET	Lamp holder adapter from GU10 to E27 in PET
	ADATTATORE-G9-E27 8031439411268 Adattatore da G9 a E27 in PET	Lamp holder adapter from G9 to E27 in PET

ADATTATORI LAMPHOLDER ADAPTERS

	ADATTATORE-G9-E14 8031439401269 Adattatore da G9 a E14 in PET	Lamp holder adapter from G9 to E14 in PET
	ADATTATORE-E27-E27 8031439451264 Adattatore da E27 a E27 in PET con flessibile 20 cm in metallo	Lamp holder adapter from E27 to E27 in PET with 20 cm metal flexible tube
	ADATTATORE-EUC-UKG 8031414879809 Adattatore presa (EU) tipo C a presa (UK) tipo G	Adaptor (EU) C to (UK) G
	ADATTATORE-EUF-UKG 8031414879816 Adattatore (EU) F a (UK) G	Adaptor (EU) F to (UK) G

SMART INTEC

SMART HUB



SMART-GATEWAY-BT
8031414878970

Interfaccia di collegamento dispositivi bluetooth con rete WIFI

Device connection interface bluetooth with WIFI network



SMART PLUG



SMART-IR
8031414878703

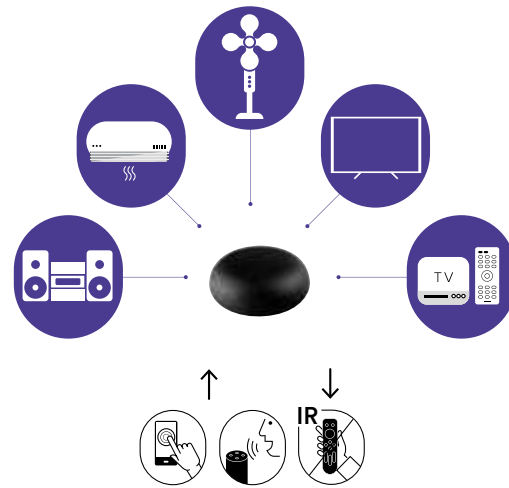

SMART PLUG



SMART-POWER-SC4USB3
8031414879014

Adattatore multipresa WIFI
4 Schuko 3 USB 1000-2400W 10A
Input 100-240V
WIFI 2.4GHZ

WIFI multi-socket adapter
4 Schuko 3 USB 1000-2400W 10A
Input 100-240V
2.4GHZ WIFI



SMART-PRESA
8031414878987

Adattatore presa
WIFI 230V 50HZ 16A
Frequenza 2.4GHz

WIFI socket adapter
230V 50HZ 16A
2.4GHz frequency



CONTROLLER SMART



SMART-SWITCH-2
8031414879045

Controller WIFI 2.4GHZ
per accensione e timer
Interruttori 2 vie 230V max 10A

2.4GHZ WIFI Controller
for ignition and timer
2-way switches 230V max 10A



SMART-SWITCH-1
8031414879038

Controller WIFI 2.4GHZ
per accensione e timer
Interruttori 1 via 230V max 10A

2.4GHZ WIFI Controller
for ignition and timer
1-way switches 230V max 10A



SMART-START
8031414879021

Controller WIFI 2.4GHz
per accensione e timer prodotti
230V max 2200W/10A

2.4GHZ WIFI Controller
for ignition and timer products
230V max 2200W/10A



SMART SENSOR



SMART-SENSOR
8031414879007

Sensore infrarossi
WIFI 2.4GHz

Infrared sensor
WIFI 2.4GHz



SMART-PORTER
8031414878994

Sensore porte e finestre
WIFI 2.4GHz alimentato
a batterie AAA1,5V2

Sensor for door and windows
WIFI 2.4ghz battery
powered AAA1,5V2



INTEC[®]
LIGHT

faneurope

divisione F.A.N. EUROPE LIGHTING s.r.l. a socio unico

Agglomerato A.S.I

NAPOLI

Località Bosco Fangone
80035 Nola (NA)

T +39 081 3151017
T +39 081 8210771

info@faneurope.it
www.faneurope.it

MILANO

Via Monzoro, 46
20007 Cornaredo (MI)

T +39 02 84345083



Download Catalogue



SMART INTEC

Download App Smart Intec on:



concept
DITRE IDEAS MAKERS

graphic artwork & photo editing
Ditre.com

photo
Quasarfoto.com
F.A.N. Europe photographic archive

imagebank
shutterstock.com
istockphoto.com
unsplash.com

styling
Cristina Romanello

credits
Infiniti Design
Pointhouse
Studio Menguante
Paolo Loschi
Gressoni
Vbc ceramiche

printed in Italy
Graficametelliana.com
October 2022

L'azienda si riserva il diritto
di effettuare modifiche ai
prodotti presenti in questo
catalogo senza preavviso alcuno
/

The company reserves
the right to make changes
to the products in this
catalog without prior notice

faneurope[®]

FOXLED[®] ALL YOUR LIGHT